

## SP 2,5/ 1-M BU

Order No.: 3043051

Illustration shows versions of the SP 2,5/1-... connector in various colors

<http://catalog.phoenixcontact.net/phoenix/treeViewClick.do?UID=3043051>

Plug, Connection method: Spring-cage connection, Number of positions: 1, Cross section: 0.08 mm<sup>2</sup> - 4 mm<sup>2</sup>, AWG: 28 - 12, Width: 5.2 mm, Height: 39 mm, Color: blue

Commercial data	
EAN	 4 017918 894917
sales group	A671
Pack	50 Pcs.
Customs tariff	85366990
Gross weight in pieces	0.003206 KG
Net weight per piece	0.0028 KG
Catalog page information	Page 420 (C-3-2013)

### Product notes

WEEE/RoHS-compliant since:  
01/01/2003

<http://www.download.phoenixcontact.com>  
Please note that the data given here has been taken from the online catalog. For comprehensive information and data, please refer to the user documentation. The General Terms and Conditions of Use apply to Internet downloads.

### Product description

Connector element center, left housing with engagement pin, right opened without cover

### Technical data

#### General

Number of levels	1
Number of connections	1

---

Color	blue
Insulating material	PA
Inflammability class according to UL 94	V0

#### General

Maximum load current	24 A (with 2.5 mm <sup>2</sup> conductor cross section)
Rated surge voltage	6 kV
Pollution degree	3
Surge voltage category	III
Insulating material group	I
Connection in acc. with standard	IEC 61984
Maximum load current (lower level)	24 A
Additional text	with 4 mm <sup>2</sup> conductor cross section
Nominal current I <sub>N</sub> (lower level)	24 A
Nominal voltage U <sub>N</sub>	500 V
Open side panel	nein
Number of positions	1

#### Dimensions

Width	5.2 mm
Length	15.8 mm
Height	39 mm

#### Connection data

Connection in acc. with standard	IEC 61984
Connection method	Spring-cage connection
Conductor cross section solid min.	0.08 mm <sup>2</sup>
Conductor cross section solid max.	4 mm <sup>2</sup>
Conductor cross section AWG/kcmil min.	28
Conductor cross section AWG/kcmil max	12
Conductor cross section stranded min.	0.08 mm <sup>2</sup>
Conductor cross section stranded max.	2.5 mm <sup>2</sup>
Min. AWG conductor cross section, stranded	28
Max. AWG conductor cross section, stranded	14
Conductor cross section stranded, with ferrule without plastic sleeve min.	0.14 mm <sup>2</sup>
Conductor cross section stranded, with ferrule without plastic sleeve max.	2.5 mm <sup>2</sup>

Conductor cross section stranded, with ferrule with plastic sleeve min.	0.14 mm <sup>2</sup>
Conductor cross section stranded, with ferrule with plastic sleeve max.	2.5 mm <sup>2</sup>
2 conductors with same cross section, stranded, TWIN ferrules with plastic sleeve, max.	0.5 mm <sup>2</sup>
Stripping length	10 mm
Internal cylindrical gage	A3
Connection method	Plug connection

### Certificates / Approvals



Certification

CSA, cULus Recognized, GOST, VDE Gutachten mit Fertigungsüberwachung, BV, DNV, GL, LR, RS, IECCEB CB Scheme

Certifications applied for:

Certification Ex:

### Accessories

Item	Designation	Description
<b>Assembly</b>		
3040559	PR	Latching, Number of positions: 1, Color: orange
3040630	PR/2	Latching, Number of positions: 2, Color: orange
3040614	PRZ	Latching, Length: 3 mm, Width: 5.2 mm, Number of positions: 2, Color: orange
3040591	PSH 3- 6	Shield connection clamp, Color: black
3040601	PSH 5-10	Shield connection clamp, Color: black
3040627	PZ/2	Strain relief, Number of positions: 2, Color: black
3040643	PZ/4	Strain relief, Number of positions: 4, Color: black
<b>General</b>		
3040631	PRT/2	Latching, can only be released using a screwdriver, Number of positions: 2, Color: orange

**Marking**

1051993	B-STIFT	Marker pen, for manual labeling of unprinted Zack strips, smear-proof and waterproof, line thickness 0.5 mm
0818153	UC-TMF 5	Marker for terminal blocks, Sheet, white, unlabeled, can be labeled with: BLUEMARK CLED, BLUEMARK LED, Plotter, Mounting type: Snap into flat marker groove, for terminal block width: 5.2 mm, Lettering field: 4.6 x 5.1 mm
0824638	UC-TMF 5 CUS	Marker for terminal blocks, can be ordered: by sheet, white, labeled according to customer specifications, Mounting type: Snap into flat marker groove, for terminal block width: 5.2 mm, Lettering field: 4.6 x 5.1 mm
0828744	UCT-TMF 5	Marker for terminal blocks, Sheet, white, unlabeled, can be labeled with: THERMOMARK CARD, BLUEMARK CLED, BLUEMARK LED, Mounting type: Snap into flat marker groove, for terminal block width: 5.2 mm, Lettering field: 4.4 x 4.7 mm
0829658	UCT-TMF 5 CUS	Marker for terminal blocks, can be ordered: by sheet, white, labeled according to customer specifications, Mounting type: Snap into flat marker groove, for terminal block width: 5.2 mm, Lettering field: 4.4 x 4.7 mm
0811228	X-PEN 0,35	Marker pen without ink cartridge, for manual labeling of markers, labeling extremely wipe-proof, line thickness 0.35 mm
0825025	ZBF 5 CUS	Zack Marker strip, flat, can be ordered: Strip, white, labeled according to customer specifications, Mounting type: Snap into flat marker groove, for terminal block width: 5 mm, Lettering field: 5.15 x 5.15 mm
0808671	ZBF 5,LGS:FORTL.ZAHLEN	Zack Marker strip, flat, Strip, white, labeled, Printed horizontally: Consecutive numbers 1 - 10, 11 - 20, etc. up to 491 - 500, Mounting type: Snap into flat marker groove, for terminal block width: 5 mm, Lettering field: 5.15 x 5.15 mm
0810821	ZBF 5,LGS:GERADE ZAHLEN	Zack Marker strip, flat, Strip, white, labeled, Printed horizontally: Consecutive numbers 2 - 20, 22 - 40, etc. up to 82 - 100, Mounting type: Snap into flat marker groove, for terminal block width: 5 mm, Lettering field: 5.15 x 5.15 mm
0810863	ZBF 5,LGS:UNGERADE ZAHLEN	Zack Marker strip, flat, Strip, white, labeled, Printed horizontally: Odd numbers 1 - 19, 21 - 39, etc. up to 81 - 99, Mounting type: Snap into flat marker groove, for terminal block width: 5 mm, Lettering field: 5.15 x 5.15 mm
0808697	ZBF 5,QR:FORTL.ZAHLEN	Zack Marker strip, flat, Strip, white, labeled, Printed vertically: Consecutive numbers 1 - 10, 11 - 20, etc. up to 91 - 100, Mounting type: Snap into flat marker groove, for terminal block width: 5 mm, Lettering field: 5.15 x 5.15 mm
0808642	ZBF 5:UNBEDRUCKT	Zack Marker strip, flat, Strip, white, unlabeled, can be labeled with: Plotter, Mounting type: Snap into flat marker groove, for terminal block width: 5 mm, Lettering field: 5.1 x 5.2 mm

Drawings

Diagram

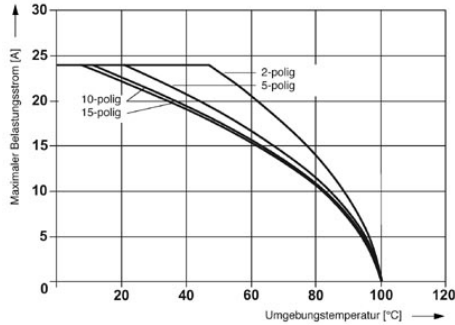

Derating curve for ST 2,5/ 1P, ST 2,5/ 2P, ST 2,5-TWIN/ 1P and for all plug versions SP... .

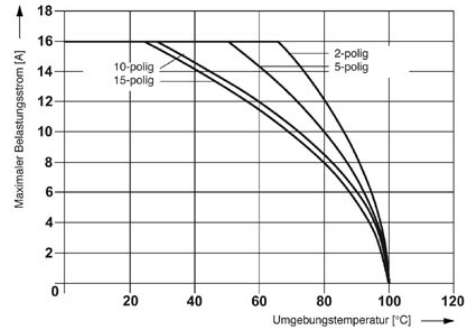

Derating curve for ST 2,5-TWIN-MT/1P, ST 2,5-TWIN-TG/1P and for all plug versions SP... .

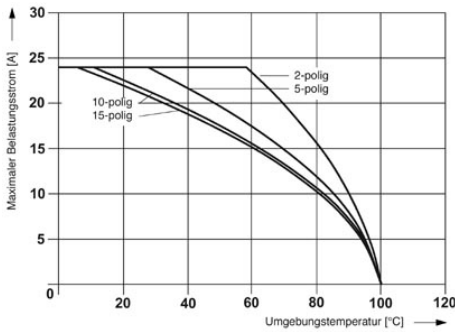

Derating curve for ST 2,5-QUATTRO/2P, ST 2,5-QUATTRO/4P and for all plug versions SP... .

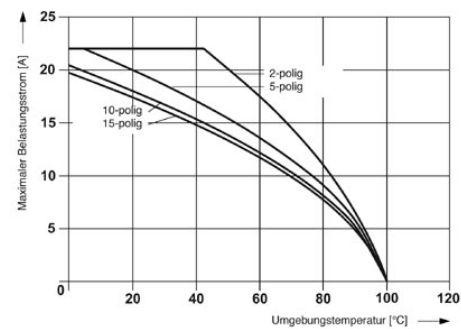

Derating curve for STTB 2,5/ 2P, STTB 2,5/ 2P-PV and for all plug versions SP... .

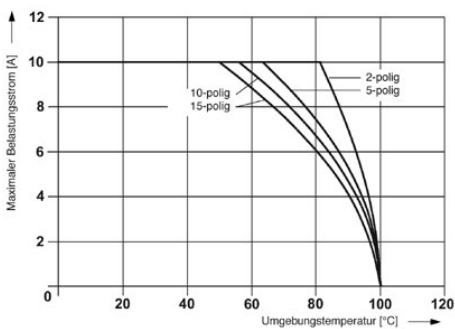

Derating curve for ST 2,5-4L/1P, ST 2,5-4L/2P and for all plug versions SP... .

Circuit diagram



Schematic diagram

---

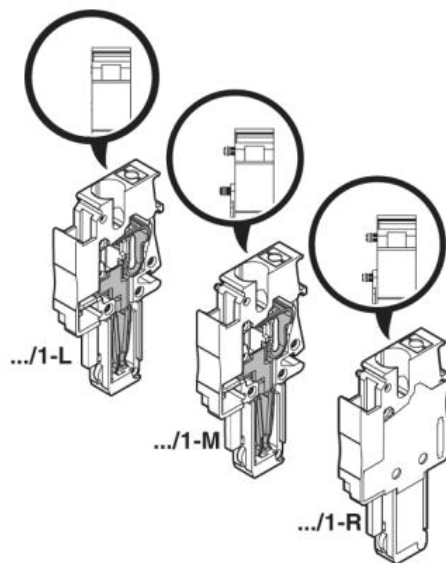

**Address**

PHOENIX CONTACT Deutschland GmbH  
Flachmarktstr. 8  
32825 Blomberg, Germany  
Phone +49 5235 3 12000  
Fax +49 5235 3 41200  
<http://www.phoenixcontact.com>



© 2014 Phoenix Contact  
Technical modifications reserved;