

WCC 30

Order No.: 3240256

<http://catalog.phoenixcontact.net/phoenix/treeViewClick.do?UID=3240256>

Cable clamp, for DIN rails

Commercial data

EAN	 4 046356 464482
sales group	B226
Pack	25 Pcs.
Customs tariff	73269098
Gross weight in pieces	0.05112 KG
Net weight per piece	0.0495 KG
Catalog page information	Page 547 (C-5-2013)

Product notesWEEE/RoHS-compliant since:
10/28/2008

<http://www.download.phoenixcontact.com>
Please note that the data given here has been taken from the online catalog. For comprehensive information and data, please refer to the user documentation. The General Terms and Conditions of Use apply to Internet downloads.

Technical data**General**

Material	Steel
----------	-------

Certificates / Approvals

Certification

Certifications applied for:

Certification Ex:

Accessories

Item	Designation	Description
------	-------------	-------------

Assembly

3240262	NS 30/15 PERF.2000MM	DIN rails, for accommodating cable clamps
---------	----------------------	---

Drawings

Dimensioned drawing

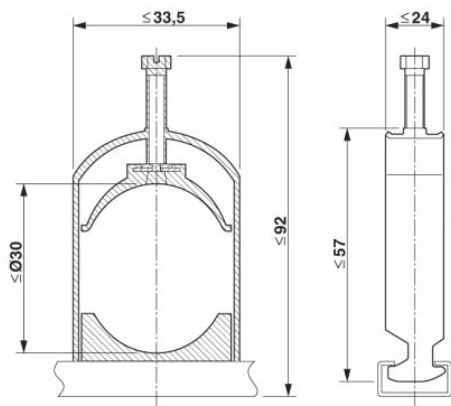

Address

PHOENIX CONTACT Deutschland GmbH
Flachmarktstr. 8
32825 Blomberg, Germany
Phone +49 5235 3 12000
Fax +49 5235 3 41200
<http://www.phoenixcontact.com>



© 2014 Phoenix Contact
Technical modifications reserved;