

IC-DFR 15

Order No.: 1852150



<http://catalog.phoenixcontact.net/phoenix/treeViewClick.do?UID=1852150>

Accessories, Number of positions: 15, Pitch: 5.08 mm, Color: green, This assembly frame can only be used in combination with IC 2,5/...-STGF-5,08

Commercial data	
EAN	 4 017918 109035
Note	Made-to-order
sales group	E190
Pack	50 Pcs.
Customs tariff	39269097
Gross weight in pieces	0.00364 KG
Net weight per piece	0.00343 KG
Catalog page information	Page 350 (C-1-2013)

Product notes

WEEE/RoHS-compliant since:
01/01/2003



<http://www.download.phoenixcontact.com>
Please note that the data given here has been taken from the online catalog. For comprehensive information and data, please refer to the user documentation. The General Terms and Conditions of Use apply to Internet downloads.

Technical data	
Dimensions	
Pitch	5.08 mm
Dimension a	71.12 mm
General	
Range of articles	IC-DFR
Insulating material group	I

Nominal cross section	2.5 mm ²
Insulating material	PA
Inflammability class according to UL 94	V0
Number of positions	15

Certificates / Approvals

Certification

Certifications applied for:

Certification Ex:

Accessories

Item	Designation	Description
Assembly		
0708263	DFK-MSTB-SS	Screw set, for securing the header to the device wall, consists of an M3 x 10 screw, with a spring washer and a nut

General

1825637	IC 2,5/15-STGF-5,08	Plug component, Nominal current: 12 A, Rated voltage (III/2): 320 V, Number of positions: 15, Pitch: 5.08 mm, Connection method: Screw connection, Color: green, Contact surface: Tin
---------	---------------------	---

Drawings

Drilling plan/solder pad geometry

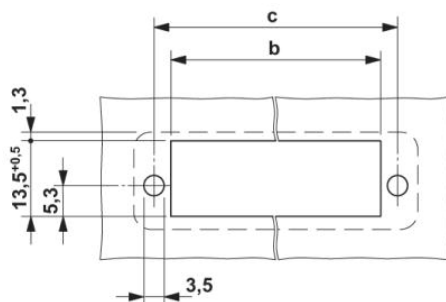

Dimension b: 10.84 mm + (no. of pos. x 5.08 mm)

Dimension c: Dim. b + 5.83 mm

Dimensioned drawing

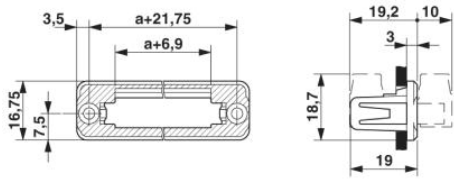

Address

PHOENIX CONTACT Deutschland GmbH
Flachmarktstr. 8
32825 Blomberg, Germany
Phone +49 5235 3 12000
Fax +49 5235 3 41200
<http://www.phoenixcontact.com>



© 2014 Phoenix Contact
Technical modifications reserved;