

Printed-circuit board connector - MCV 1,5/10-G-3,5 P26 THR - 1779527

Please be informed that the data shown in this PDF Document is generated from our Online Catalog. Please find the complete data in the user's documentation. Our General Terms of Use for Downloads are valid (<http://download.phoenixcontact.com>)

Header, Nominal current: 8 A, Rated voltage (III/2): 160 V, Number of positions: 10, Pitch: 3.5 mm, Color: Black, Contact surface: Tin, Assembly: SMD/THT/THR, User information and design recommendations for through hole reflow technology can be found under "Downloads"



The figure shows a 10-position version of the product

Product Features

- Plug-in direction vertical to the PCB
- Pitch: 3.5 and 3.81 mm
- Low-profile THR headers with compact pitches
- Delivery form: box packaging, in bulk for small series
- Use in SMT reflow processes



Key commercial data

Packing unit	1 PCE
GTIN	 4 046356 531825
Custom tariff number	85366990
Country of origin	GERMANY

Technical data

Dimensions / positions

Length	7.25 mm
Pitch	3.5 mm
Dimension a	31.5 mm
Number of positions	10
Pin dimensions	0,8 x 0,8 mm
Hole diameter	1.4 mm

Printed-circuit board connector - MCV 1,5/10-G-3,5 P26 THR - 1779527

Technical data

Technical data

Range of articles	MCV 1,5/...-G-THR
Insulating material group	IIIa
Rated surge voltage (III/3)	2.5 kV
Rated surge voltage (III/2)	2.5 kV
Rated surge voltage (II/2)	2.5 kV
Rated voltage (III/2)	160 V
Rated voltage (II/2)	250 V
Connection in acc. with standard	EN-VDE
Nominal current I_N	8 A
Nominal voltage U_N	160 V
Maximum load current	8 A
Insulating material	LCP
Inflammability class according to UL 94	V0
Color	Black
Nominal voltage, UL/CUL Use Group B	300 V
Nominal current, UL/CUL Use Group B	8 A
Nominal voltage, UL/CUL Use Group D	300 V
Nominal current, UL/CUL Use Group D	8 A

Classifications

ETIM

ETIM 4.0	EC002637
ETIM 5.0	EC002637

UNSPSC

UNSPSC 11	39121409
UNSPSC 12.01	39121409
UNSPSC 13.2	39121409
UNSPSC 6.01	30211810
UNSPSC 7.0901	39121409

eCl@ss

eCl@ss 4.0	272607xx
eCl@ss 4.1	27260701
eCl@ss 5.0	27260701
eCl@ss 5.1	27260701

Printed-circuit board connector - MCV 1,5/10-G-3,5 P26 THR - 1779527

Classifications

eCl@ss

eCl@ss 6.0	27260704
eCl@ss 7.0	27440402

Approvals

Approvals

Approvals

UL Recognized / cUL Recognized / GOST / GOST / cULus Recognized

Ex Approvals

Approvals submitted

Approval details

UL Recognized 		
	B	D
Nominal current I _N	8 A	8 A
Nominal voltage U _N	300 V	300 V

cUL Recognized 		
	B	D
Nominal current I _N	8 A	8 A
Nominal voltage U _N	300 V	300 V

GOST 		
--	--	--

Printed-circuit board connector - MCV 1,5/10-G-3,5 P26 THR - 1779527

Approvals

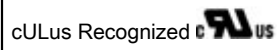

Drawings

Diagram

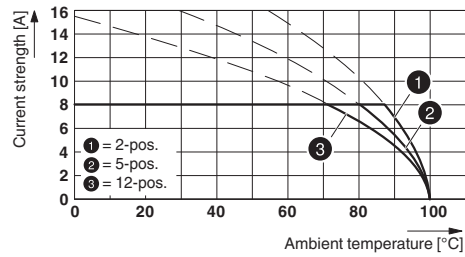

Type: MC 1,5/...-ST(F)-3,5 with MCV 1,5/...-G(F)-3,5 P.. THR

Printed-circuit board connector - MCV 1,5/10-G-3,5 P26 THR - 1779527

Dimensioned drawing

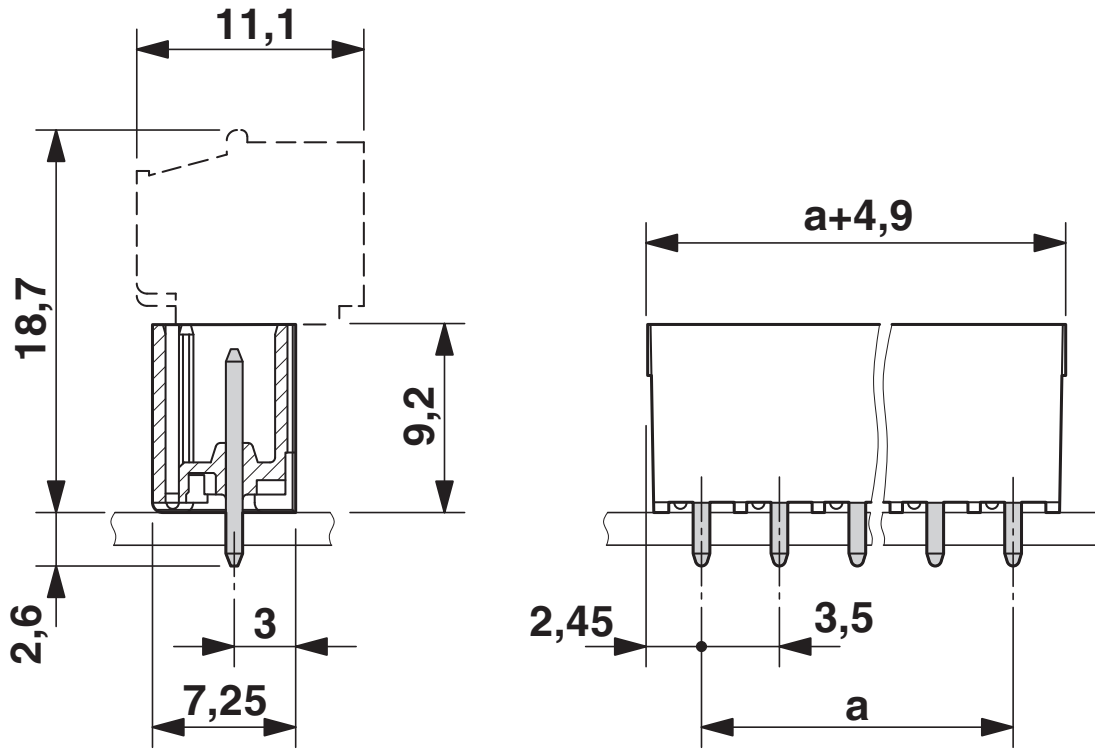

Printed-circuit board connector - MCV 1,5/10-G-3,5 P26 THR - 1779527

Drilling diagram

