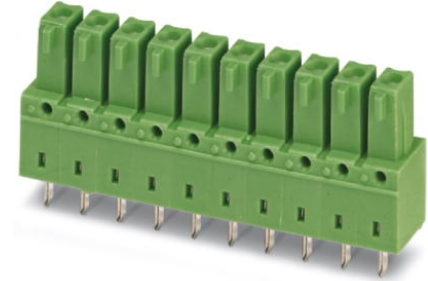

IMCV 1,5/11-G-3,81

Order No.: 1875519

The figure shows a 16-pos. version of the product

<http://eshop.phoenixcontact.de/phoenix/treeViewClick.do?UID=1875519>Header, Nominal current: 8 A, Nom. voltage: 160 V, Pitch: 3.81 mm,
Number of positions: 11, Color: green, Assembly: Soldering

Commercial data

EAN	4017918134013
Pack	50 pcs.
Customs tariff	85366990
Weight/Piece	0.00367 KG
Catalog page information	Page 187 (CC-2009)

Product notes

WEEE/RoHS-compliant since:
01/01/2003

<http://www.download.phoenixcontact.com>
Please note that the data given here has been taken from the online catalog. For comprehensive information and data, please refer to the user documentation. The General Terms and Conditions of Use apply to Internet downloads.

Technical data

Dimensions / positions

Length	6.85 mm
Pitch	3.81 mm
Dimension a	38.1 mm
Number of positions	11
Pin dimensions	0,8 x 0,8 mm

Hole diameter	1.2 mm
Technical data	
Insulating material group	I
Rated surge voltage (III/3)	2.5 kV
Rated surge voltage (III/2)	2.5 kV
Rated surge voltage (II/2)	2.5 kV
Rated voltage (III/2)	160 V
Rated voltage (II/2)	320 V
Connection in acc. with standard	EN-VDE
Nominal current I_N	8 A
Nominal voltage U_N	160 V
Maximum load current	8 A
Insulating material	PA
Inflammability class acc. to UL 94	V0

Accessories

Item	Designation	Description
0804109	SK 3,81/2,8:FORTL.ZAHLEN	Marker card, printed horizontally, self-adhesive, 10-section marker strip, 14 identical decades marked 1-10, 11-20 etc. up to 91-(99)100, sufficient for 140 terminal blocks

Drawings

Drilling diagram

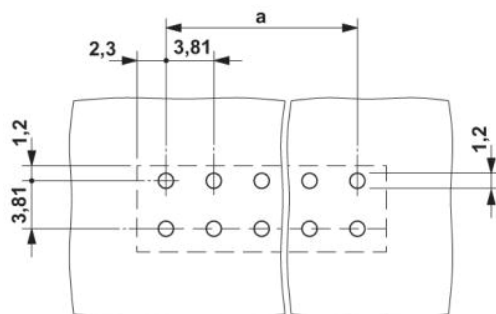

Dimensioned drawing

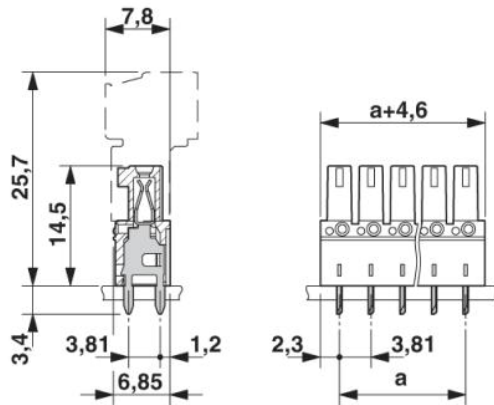

Address

PHOENIX CONTACT GmbH & Co. KG
Flachsmarktstr. 8
32825 Blomberg, Germany
Phone +49 5235 3 00
Fax +49 5235 3 41200
<http://www.phoenixcontact.com>



© 2009 Phoenix Contact
Technical modifications reserved;