

CC 2,5/ 3-GF-5,08 P26THRR56

Order No.: 1954812

<http://eshop.phoenixcontact.de/phoenix/treeViewClick.do?UID=1954812>Header, Nominal current: 12 A, Nom. voltage: 250 V, Pitch: 5.08 mm,
Number of positions: 3, Color: black, Assembly: SMD/THT/THR**Commercial data**

EAN	4017918925635
Pack	330 pcs.
Customs tariff	85366990
Weight/Piece	0.00402 KG
Catalog page information	Page 239 (CC-2009)

Product notesWEEE/RoHS-compliant since:
01/01/2003

<http://www.download.phoenixcontact.com>
Please note that the data given here has been taken from the online catalog. For comprehensive information and data, please refer to the user documentation. The General Terms and Conditions of Use apply to Internet downloads.

Technical data**Dimensions / positions**

Pitch	5.08 mm
Dimension a	10.16 mm
Number of positions	3
Pin dimensions	1 x 1 mm
Pin spacing	5.08 mm

Hole diameter	1.6 mm
Technical data	
Insulating material group	IIIa
Rated surge voltage (III/3)	4 kV
Rated surge voltage (III/2)	4 kV
Rated surge voltage (II/2)	4 kV
Rated voltage (III/2)	320 V
Rated voltage (II/2)	400 V
Connection in acc. with standard	EN-VDE
Nominal current I_N	12 A
Nominal voltage U_N	250 V
Maximum load current	12 A (per position)
Insulating material	LCP
Inflammability class acc. to UL 94	V0

Accessories

Item	Designation	Description
General		
1954362	CR-MSTB NAT HT	HT coding section, is pushed into the recess on the header before the reflow process, made of highly temperature-resistant, beige insulating material
Marking		
1051993	B-STIFT	Marker pen, for manual labeling of unprinted Zack strips, smear-proof and waterproof, line thickness 0.5 mm
0804303	SK 5,08/3,8: 0-9	Marker card, printed horizontally, self-adhesive, 10-section marker strip, 12 identical decades marked 0-9, sufficient for 120 terminal blocks
0804293	SK 5,08/3,8:FORTL.ZAHLEN	Marker card, printed horizontally, self-adhesive, 12 identical decades marked 1-10, 11-20 etc. up to 91-(99)100, sufficient for 120 terminal blocks
0805085	SK 5,08/3,8:SO	Marker card, special printing, self-adhesive, labeled acc. to customer requirements, 12 identical marker strips per card, max. 25-position labeling per strip, color: white
0805412	SK 5,08/3,8:UNBEDRUCKT	Marker cards, unprinted, with pitch divisions, self-adhesive, 10-section marker strips, 12 strips per card, can be labeled with the M-PEN

Plug/Adapter

1734401	CR-MSTB	Coding section, inserted into the recess in the header or the inverted plug, red insulating material
---------	---------	--

Drawings

Drilling diagram

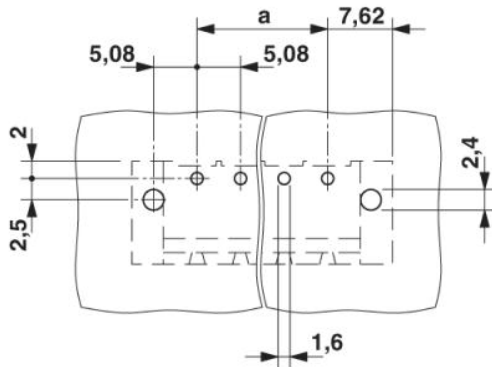

Dimensioned drawing

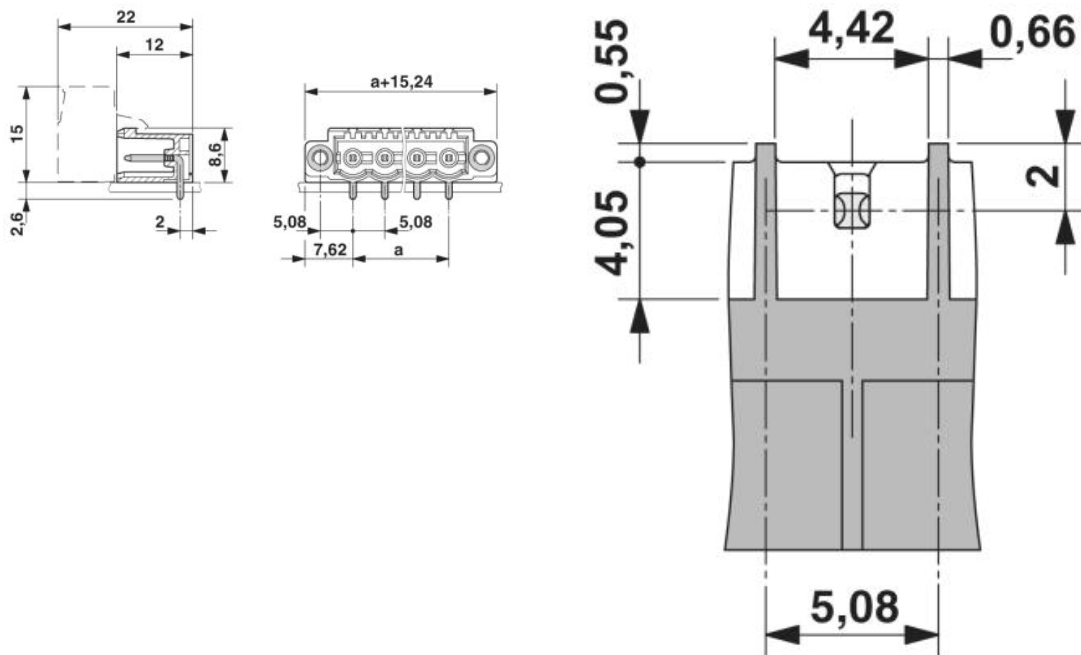

Bottom view, free space for solder paste, 0.5 mm deep

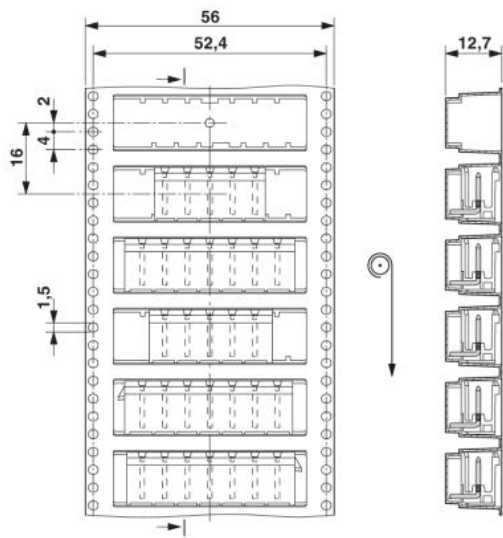

Direction of the arrow = feeding direction

Address

PHOENIX CONTACT GmbH & Co. KG
Flachsmarktstr. 8
32825 Blomberg, Germany
Phone +49 5235 3 00
Fax +49 5235 3 41200
<http://www.phoenixcontact.com>



© 2009 Phoenix Contact
Technical modifications reserved;