

ICV 2,5/15-GF-5,08

Order No.: 1825828

The figure shows a 10-position version of the product

<http://eshop.phoenixcontact.de/phoenix/treeViewClick.do?UID=1825828>Header, Nominal current: 12 A, Nom. voltage: 320 V, Pitch: 5.08 mm,
Number of positions: 15, Assembly: Soldering

Commercial data

EAN	4017918049980
Pack	50 pcs.
Customs tariff	85366990
Weight/Piece	0.01244 KG
Catalog page information	Page 265 (CC-2009)

Product notes

WEEE/RoHS-compliant since:
01/01/2003

<http://www.download.phoenixcontact.com>
Please note that the data given here has been taken from the online catalog. For comprehensive information and data, please refer to the user documentation. The General Terms and Conditions of Use apply to Internet downloads.

Technical data

Dimensions / positions

Length	10.2 mm
Pitch	5.08 mm
Dimension a	71.12 mm
Number of positions	15
Pin dimensions	1,2 x 0,5

Hole diameter	1.4 mm
Technical data	
Insulating material group	I
Rated surge voltage (III/3)	4 kV
Rated surge voltage (III/2)	4 kV
Rated surge voltage (II/2)	4 kV
Rated voltage (III/2)	320 V
Rated voltage (II/2)	630 V
Connection in acc. with standard	EN-VDE
Nominal current I_N	12 A
Nominal voltage U_N	320 V
Maximum load current	12 A
Insulating material	PA
Inflammability class acc. to UL 94	V0

Accessories

Item	Designation	Description
Plug/Adapter		
1734634	CP-MSTB	Keying profile, is inserted into the slot on the plug or inverted header, red insulating material
0201744	MPS-MT	Metal part for test connector
0201647	RPS	Reducing plug, Color: gray

Drawings

Drilling diagram

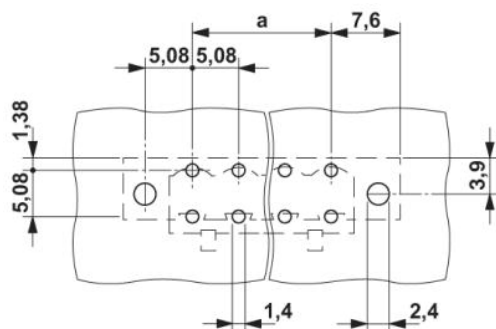

Dimensioned drawing

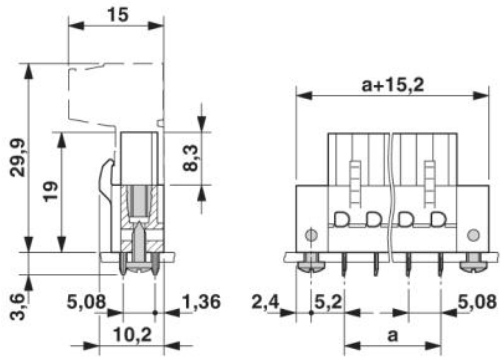

Address

PHOENIX CONTACT GmbH & Co. KG
Flachsmarktstr. 8
32825 Blomberg, Germany
Phone +49 5235 3 00
Fax +49 5235 3 41200
<http://www.phoenixcontact.com>



© 2009 Phoenix Contact
Technical modifications reserved;