

SAC-3P-M12Y/2X0,6-PUR/M12FR B

Order No.: 1669000

<http://eshop.phoenixcontact.de/phoenix/treeViewClick.do?UID=1669000>

Sensor/actuator cable, 3-pos., PUR halogen-free black, straight M12 Y-plug, on 2x angled M12 socket, PIN 2+4 bridged, cable length: 0.6 m

Commercial data

EAN	4017918136048
Pack	1 pcs.
Customs tariff	85444290
Weight/Piece	0.0681 KG
Catalog page information	Page 100 (PC-2009)

Product notes

WEEE/RoHS-compliant since:
11/17/2006



<http://www.download.phoenixcontact.com>
Please note that the data given here has been taken from the online catalog. For comprehensive information and data, please refer to the user documentation. The General Terms and Conditions of Use apply to Internet downloads.

Technical data**General data**

Nominal current I_N	4 A
Nominal voltage U_N	250 V
Number of positions	3
Volume resistance	$\leq 5 \text{ m}\Omega$

Insulation resistance	≥ 100 MΩ
Length of cable	0.6 m
Ambient temperature (operation)	-25 °C ... 90 °C (plug/socket)
	-40 °C ... 80 °C (cable, fixed installation)
	-5 °C ... 80 °C (cable, flexible installation)

General characteristics

Coding	A - standard
Inflammability class acc. to UL 94	HB
Surge voltage category	II
Pollution degree	3
Degree of protection	IP65/IP68/IP69K
Contact material	CuSn
Contact surface material	Ni/Au
Contact carrier material	TPU GF
Material of grip body	TPU, hardly inflammable, self-extinguishing
Material, knurls	Zinc die-cast, (nickel-plated)
Sealing material	NBR
Status display	No

Conductor data

Cable type	PUR halogen-free black
Cable type (abbreviation)	PUR
Cable abbreviation	Li9Y11Y
Conductor cross section	0.34 mm ²
AWG signal line	22
Conductor structure, signal line	42x 0.10 mm
Core diameter including insulation	1.27 mm ±0.02 mm
Thickness, insulation	≥ 0.21 mm (Core insulation)
	≥ 0.76 mm (Outer cable sheath)
External cable diameter	4.40 mm
Wire colors	Brown, blue, black
External sheath, color	Black-gray RAL 7021
Insulation resistance	≥ 100 GΩ*km
Conductor resistance	≤ 58 Ω/m
Nominal voltage, conductor	300 V

Test voltage, conductor	3000 V
Overall twist	3 wires, twisted
Outer sheath, material	PUR
Material conductor insulation	PP
Conductor material	Bare Cu litz wires
Cable weight	26 kg/km
Smallest bending radius, movable installation	44 mm
Number of bending cycles	4000000
Bending radius	44 mm
Traversing path	10 m
Traversing rate	3 m/s
Acceleration	10 m/s ²
Special properties	Flexible cable conduit capable
	Silicone-free
	Free of substances which would hinder coating with paint or varnish
Flame resistance	As per UL-Style 20549
Freedom from halogen	As per DIN VDE 0472 part 815
Resistance to oil	complying with DIN EN 60811-2-1
Other resistance	Highly resistant to acids, alkaline solutions and solvents
	hydrolysis and microbe resistant

Drawings

Dimensioned drawing

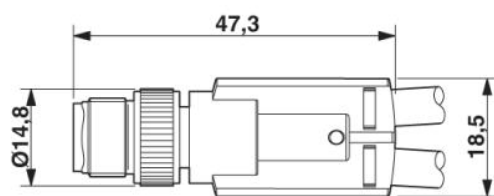

Plug M12 x 1, Y distributor

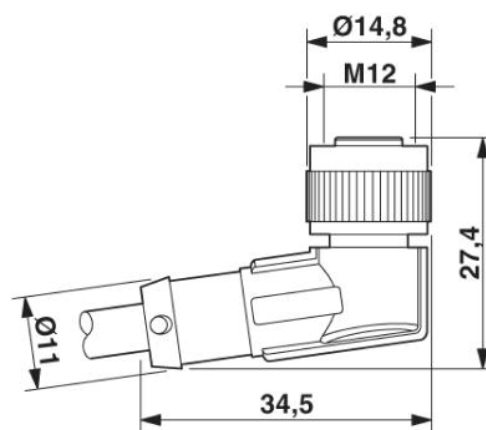

M12 x 1 female connector, angled

Circuit diagram

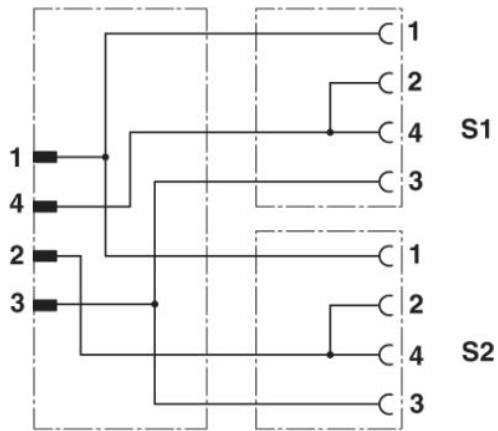

Contact assignment of the M12 plug and the M12 socket

Schematic diagram

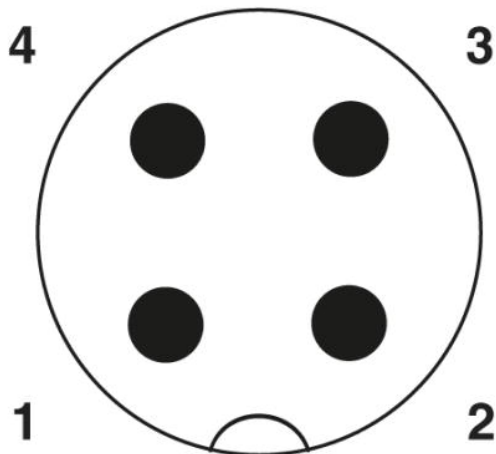

Pin assignment M12 Y plug, 4-pos., A-coded, view plug side

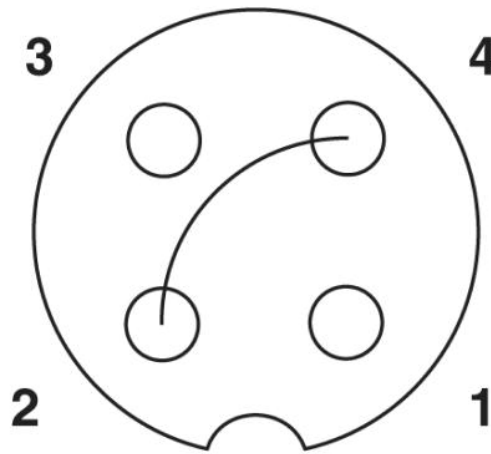

Pin assignment M12 socket, 3-pos., PIN 2+4 bridged, A-coded, view female side

Address

PHOENIX CONTACT GmbH & Co. KG
Flachmarktstr. 8
32825 Blomberg, Germany
Phone +49 5235 3 00
Fax +49 5235 3 41200
<http://www.phoenixcontact.com>



© 2009 Phoenix Contact
Technical modifications reserved;