

**SAC-3P-M12Y/2X1,5-PUR/M 8FR**

Order No.: 1671399

<http://eshop.phoenixcontact.de/phoenix/treeViewClick.do?UID=1671399>Sensor/actuator cable, 3-pos., PUR halogen-free black, straight M12  
Y-plug, on 2x angled M8 socket, cable length: 1.5 m**Commercial data**

EAN	4017918135225
Pack	1 pcs.
Customs tariff	85444290
Weight/Piece	0.0911 KG
Catalog page information	Page 100 (PC-2009)

**Product notes**WEEE/RoHS-compliant since:  
11/17/2006

<http://www.download.phoenixcontact.com>  
Please note that the data given here has been taken from the online catalog. For comprehensive information and data, please refer to the user documentation. The General Terms and Conditions of Use apply to Internet downloads.

**Technical data****General data**

Nominal current $I_N$	4 A
Nominal voltage $U_N$	60 V
Number of positions	3
Volume resistance	$\leq 5 \text{ m}\Omega$
Insulation resistance	$\geq 100 \text{ M}\Omega$

Length of cable	1.5 m
Ambient temperature (operation)	-25 °C ... 90 °C (plug/socket)
	-40 °C ... 80 °C (cable, fixed installation)
	-5 °C ... 80 °C (cable, flexible installation)

#### General characteristics

Coding	A - standard
Inflammability class acc. to UL 94	HB
Surge voltage category	II
Pollution degree	3
Degree of protection	IP65/IP68/IP69K
Contact material	CuSn
Contact surface material	Ni/Au
Contact carrier material	TPU GF
Material of grip body	TPU, hardly inflammable, self-extinguishing
Material, knurls	Zinc die-cast, (nickel-plated)
Sealing material	NBR
Status display	No

#### Conductor data

Cable type	PUR halogen-free black
Cable type (abbreviation)	PUR
Cable abbreviation	Li9Y11Y-HF
Conductor cross section	0.25 mm <sup>2</sup>
AWG signal line	24
Conductor structure, signal line	32 x 0.10 mm
Core diameter including insulation	1.15 mm ±0.05 mm
Thickness, insulation	≥ 0.38 mm (Core insulation)
External cable diameter	4.40 mm
Wire colors	Brown, blue, black
External sheath, color	Black-gray RAL 7021
Insulation resistance	≥ 100 GΩ*km
Conductor resistance	≤ 77.6 MΩ/km
Nominal voltage, conductor	300 V
Test voltage, conductor	4000 V
Overall twist	3 wires, twisted

Outer sheath, material	PUR
Material conductor insulation	PP
Conductor material	Bare Cu litz wires
Cable weight	23 kg/km
Smallest bending radius, movable installation	44 mm
Number of bending cycles	4000000
Bending radius	44 mm
Traversing path	10 m
Traversing rate	3 m/s
Acceleration	10 m/s <sup>2</sup>
Special properties	Flexible cable conduit capable Silicone-free Free of substances which would hinder coating with paint or varnish
Flame resistance	As per UL-Style 20549
Freedom from halogen	As per DIN VDE 0472 part 815
Resistance to oil	complying with DIN EN 60811-2-1
Other resistance	Highly resistant to acids, alkaline solutions and solvents hydrolysis and microbe resistant

## Drawings

### Dimensioned drawing

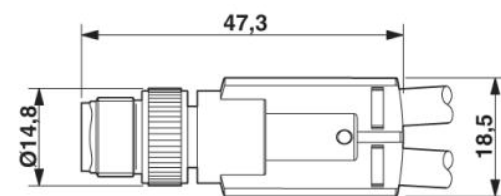

Plug M12 x 1, Y distributor

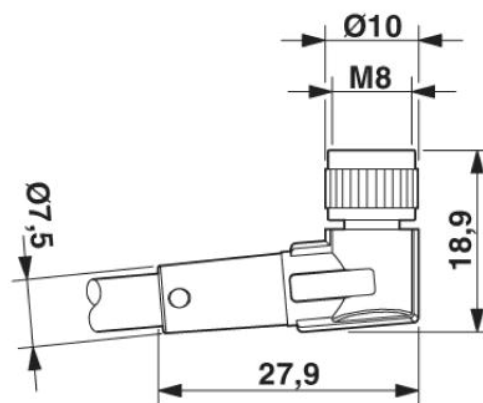

Socket M8 x 1, angled

Circuit diagram

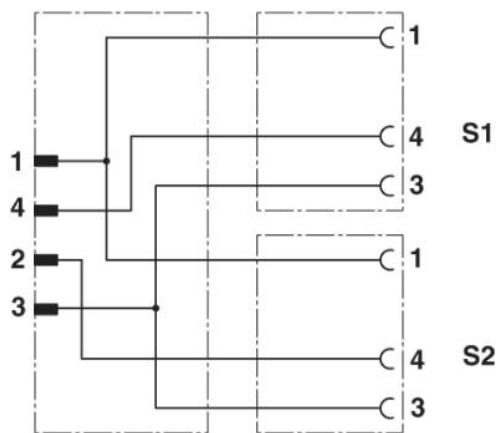

Contact assignment of M12 plugs / M8 sockets

Schematic diagram

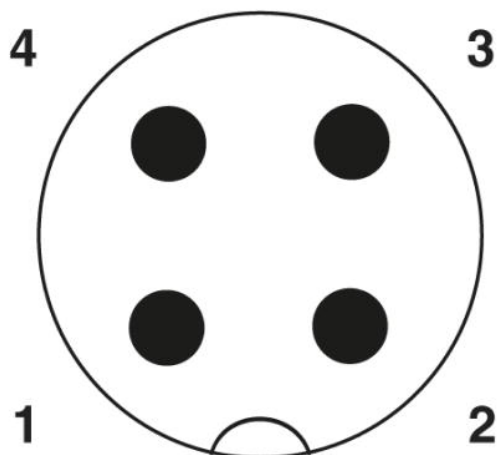

Pin assignment M12 Y plug, 4-pos., A-coded, view plug side

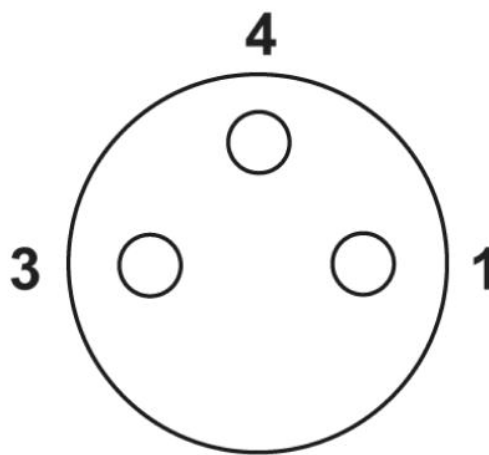

Pin assignment M8 socket, 3-pos., view female side

**Address**

PHOENIX CONTACT GmbH & Co. KG  
Flachsmarktstr. 8  
32825 Blomberg, Germany  
Phone +49 5235 3 00  
Fax +49 5235 3 41200  
<http://www.phoenixcontact.com>



© 2009 Phoenix Contact  
Technical modifications reserved;