

## SMSTBA 2,5/ 3-G

Order No.: 1769816

The figure shows a 10-position version of the product

<http://eshop.phoenixcontact.de/phoenix/treeViewClick.do?UID=1769816>Header, Nominal current: 12 A, Nom. voltage: 250 V, Pitch: 5 mm,  
Number of positions: 3, Color: green, Assembly: Soldering

### Commercial data

EAN	4017918035037
Pack	50 pcs.
Customs tariff	85366990
Weight/Piece	0.00266 KG
Catalog page information	Page 253 (CC-2009)

### Product notes

WEEE/RoHS-compliant since:  
01/01/2003

<http://www.download.phoenixcontact.com>  
Please note that the data given here has been taken from the online catalog. For comprehensive information and data, please refer to the user documentation. The General Terms and Conditions of Use apply to Internet downloads.

### Technical data

#### Dimensions / positions

Pitch	5 mm
Dimension a	10 mm
Number of positions	3
Pin dimensions	1 x 1 mm
Hole diameter	1.4 mm

#### Technical data

Insulating material group	IIIa
Rated surge voltage (III/3)	4 kV
Rated surge voltage (III/2)	4 kV
Rated surge voltage (II/2)	4 kV
Rated voltage (III/2)	320 V
Rated voltage (II/2)	400 V
Connection in acc. with standard	EN-VDE
Nominal current $I_N$	12 A
Nominal voltage $U_N$	250 V
Maximum load current	12 A
Insulating material	PBT
Inflammability class acc. to UL 94	V0

#### Accessories

Item	Designation	Description
------	-------------	-------------

#### Assembly

1755477	MSTB-BL	Keying cap, for forming sections, plugs onto header pin, green insulating material
---------	---------	--

#### Marking

0804183	SK 5/3,8:FORTL.ZAHLEN	Marker card, printed horizontally, self-adhesive, 12 identical decades marked 1-10, 11-20 etc. up to 91-(99)100, sufficient for 120 terminal blocks
---------	-----------------------	---

#### Plug/Adapter

1734401	CR-MSTB	Coding section, inserted into the recess in the header or the inverted plug, red insulating material
---------	---------	--

## Drawings

### Drilling diagram

---

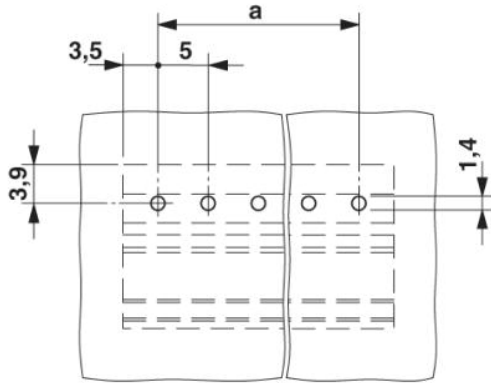

### Dimensioned drawing

---

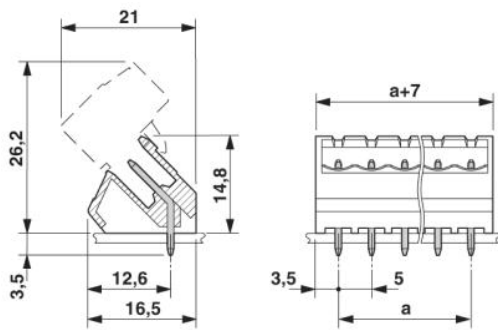

**Address**

PHOENIX CONTACT GmbH & Co. KG  
Flachsmarktstr. 8  
32825 Blomberg, Germany  
Phone +49 5235 3 00  
Fax +49 5235 3 41200  
<http://www.phoenixcontact.com>



© 2009 Phoenix Contact  
Technical modifications reserved;