

PTA 1,5/15-5,0

Order No.: 1988930

The figure shows a 10-position version of the product

<http://eshop.phoenixcontact.de/phoenix/treeViewClick.do?UID=1988930>

PC terminal block, Nominal current: 17.5 A, Nom. voltage: 250 V,
Pitch: 5 mm, Number of positions: 15, Type of connection: Screw
connection, Assembly: Soldering, Conductor/PCB connection
direction: 45 °, Color: green

Commercial data

EAN	4046356036924
Pack	50 pcs.
Customs tariff	85369010
Weight/Piece	0.01594 KG
Catalog page information	Page 469 (CC-2009)

Product notes

WEEE/RoHS-compliant since:
08/26/2003



<http://www.download.phoenixcontact.com>
Please note that the data given here has been taken from the online catalog. For comprehensive information and data, please refer to the user documentation. The General Terms and Conditions of Use apply to Internet downloads.

Technical data

Dimensions / positions

Pitch	5 mm
Dimension a	70 mm
Number of positions	15

Pin dimensions	1,0 mm
Pin spacing	5 mm
Hole diameter	1.3 mm
Screw thread	M2,6
Tightening torque, min	0.35 Nm
Tightening torque max	0.4 Nm

Technical data

Insulating material group	I
Rated surge voltage (III/3)	4 kV
Rated surge voltage (III/2)	4 kV
Rated surge voltage (II/2)	4 kV
Rated voltage (III/2)	320 V
Rated voltage (II/2)	630 V
Connection in acc. with standard	EN-VDE
Nominal current I_N	17.5 A
Nominal voltage U_N	250 V
Nominal cross section	1.5 mm ²
Maximum load current	24 A
Insulating material	PA
Inflammability class acc. to UL 94	V0
Internal cylindrical gage	A1 / B1
Stripping length	5 mm

Connection data

Conductor cross section solid min.	0.14 mm ²
Conductor cross section solid max.	2.5 mm ²
Conductor cross section stranded min.	0.14 mm ²
Conductor cross section stranded max.	2.5 mm ²
Conductor cross section stranded, with ferrule without plastic sleeve min.	0.25 mm ²
Conductor cross section stranded, with ferrule without plastic sleeve max.	1.5 mm ²
Conductor cross section stranded, with ferrule with plastic sleeve min.	0.25 mm ²
Conductor cross section stranded, with ferrule with plastic sleeve max.	1.5 mm ²
Conductor cross section AWG/kcmil min.	26

Conductor cross section AWG/kcmil max	14
2 conductors with same cross section, solid min.	0.14 mm ²
2 conductors with same cross section, solid max.	1 mm ²
2 conductors with same cross section, stranded min.	0.14 mm ²
2 conductors with same cross section, stranded max.	0.75 mm ²
2 conductors with same cross section, stranded, ferrules without plastic sleeve, min.	0.25 mm ²
2 conductors with same cross section, stranded, ferrules without plastic sleeve, max.	0.34 mm ²
2 conductors with same cross section, stranded, TWIN ferrules with plastic sleeve, min.	0.25 mm ²
2 conductors with same cross section, stranded, TWIN ferrules with plastic sleeve, max.	0.75 mm ²

Accessories

Item	Designation	Description
Marking		
0804183	SK 5/3,8:FORTL.ZAHLEN	Marker card, printed horizontally, self-adhesive, 12 identical decades marked 1-10, 11-20 etc. up to 91-(99)100, sufficient for 120 terminal blocks

Tools

1205053	SZS 0,6X3,5	Screwdriver, bladed, matches all screw terminal blocks up to 4.0 mm ² connection cross section, blade: 0.6 x 3.5 mm, without VDE approval
---------	-------------	--

Drawings

Drilling diagram

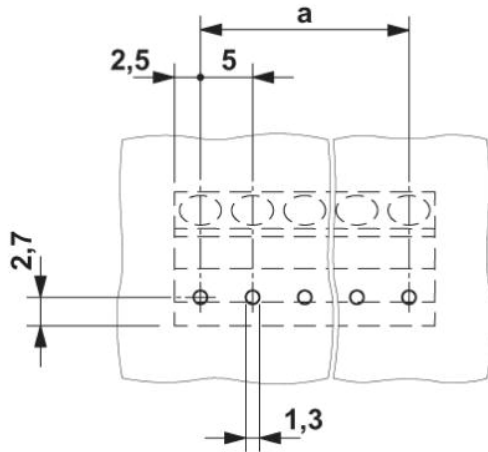

Diagram

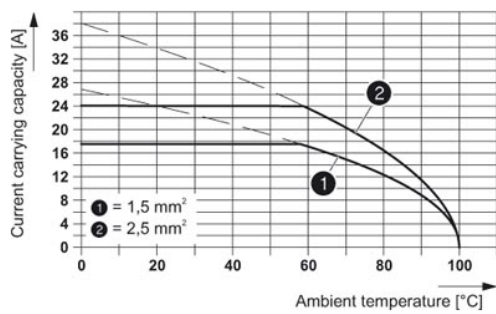

Dimensioned drawing

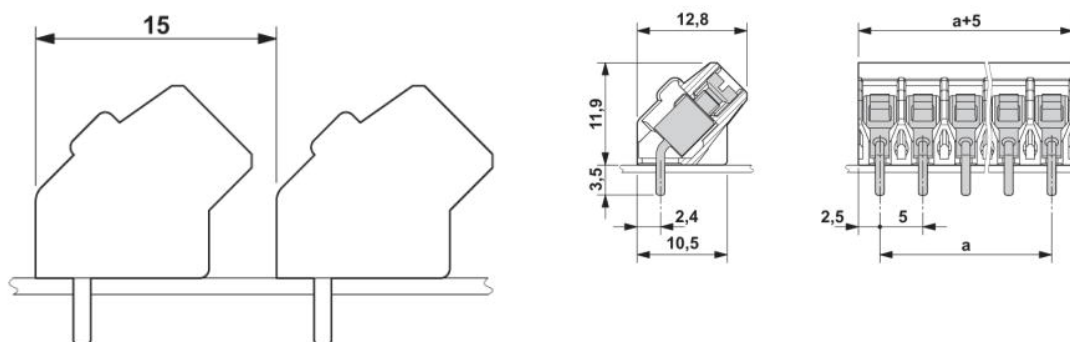

Address

PHOENIX CONTACT GmbH & Co. KG
Flachsmarktstr. 8
32825 Blomberg, Germany
Phone +49 5235 3 00
Fax +49 5235 3 41200
<http://www.phoenixcontact.com>



© 2009 Phoenix Contact
Technical modifications reserved;