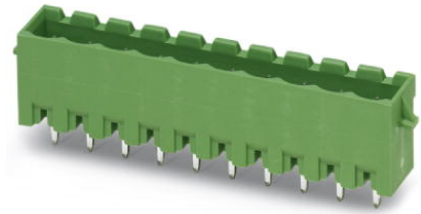

MSTBVA 2,5/ 7-G-RN

Order No.: 1944644

The figure shows a 10-position version of the product

<http://eshop.phoenixcontact.de/phoenix/treeViewClick.do?UID=1944644>Header, Nominal current: 12 A, Nom. voltage: 250 V, Pitch: 5 mm,
Number of positions: 7, Assembly: Soldering

Commercial data

| | |
|--------------------------|--------------------|
| EAN | 4017918892920 |
| Pack | 50 pcs. |
| Customs tariff | 85366990 |
| Weight/Piece | 0.003268 KG |
| Catalog page information | Page 253 (CC-2009) |

Product notes

WEEE/RoHS-compliant since:
01/01/2003

<http://www.download.phoenixcontact.com>
Please note that the data given here has been taken from the online catalog. For comprehensive information and data, please refer to the user documentation. The General Terms and Conditions of Use apply to Internet downloads.

Technical data

Dimensions / positions

| | |
|---------------------|--------|
| Length | 8.6 mm |
| Pitch | 5 mm |
| Number of positions | 7 |

Technical data

| | |
|------------------------------------|--------|
| Insulating material group | I |
| Rated surge voltage (III/3) | 4 kV |
| Rated surge voltage (III/2) | 4 kV |
| Rated surge voltage (II/2) | 4 kV |
| Rated voltage (III/2) | 320 V |
| Rated voltage (II/2) | 400 V |
| Connection in acc. with standard | EN-VDE |
| Nominal current I_N | 12 A |
| Nominal voltage U_N | 250 V |
| Inflammability class acc. to UL 94 | V0 |

Drawings

Drilling diagram

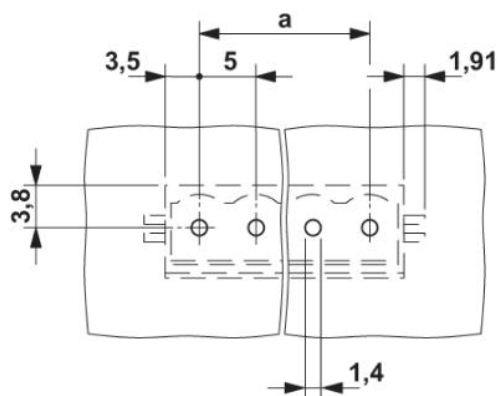

Dimensioned drawing

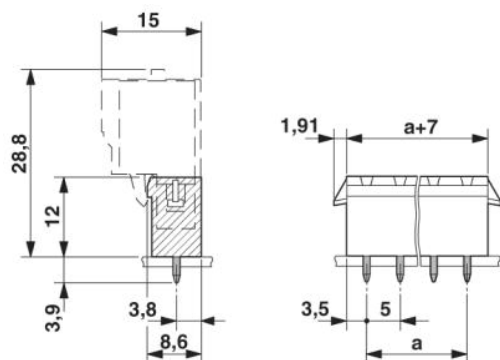

Address

PHOENIX CONTACT GmbH & Co. KG
Flachsmarktstr. 8
32825 Blomberg, Germany
Phone +49 5235 3 00
Fax +49 5235 3 41200
<http://www.phoenixcontact.com>



© 2009 Phoenix Contact
Technical modifications reserved;