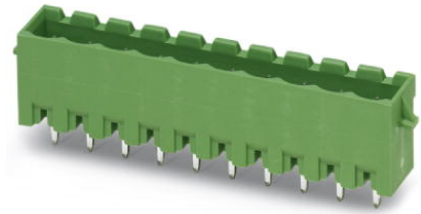

MSTBVA 2,5/ 2-G-5,08-RN

Order No.: 1936018

The figure shows a 10-position version of the product

<http://eshop.phoenixcontact.de/phoenix/treeViewClick.do?UID=1936018>Header, Nominal current: 12 A, Nom. voltage: 250 V, Pitch: 5.08 mm,
Number of positions: 2, Color: green, Assembly: Soldering

Commercial data

EAN	4017918822002
Pack	50 pcs.
Customs tariff	85366990
Weight/Piece	0.00139 KG
Catalog page information	Page 253 (CC-2009)

Product notes

WEEE/RoHS-compliant since:
01/01/2003

<http://www.download.phoenixcontact.com>
Please note that the data given here has been taken from the online catalog. For comprehensive information and data, please refer to the user documentation. The General Terms and Conditions of Use apply to Internet downloads.

Technical data

Dimensions / positions

Length	8.6 mm
Pitch	5.08 mm
Dimension a	10.16 mm
Number of positions	2
Pin dimensions	1 x 1 mm

Pin spacing	5.08 mm
Hole diameter	1.4 mm

Technical data

Insulating material group	IIIa
Rated surge voltage (III/3)	4 kV
Rated surge voltage (III/2)	4 kV
Rated surge voltage (II/2)	4 kV
Rated voltage (III/2)	320 V
Rated voltage (II/2)	400 V
Connection in acc. with standard	EN-VDE
Nominal current I_N	12 A
Nominal voltage U_N	250 V
Maximum load current	12 A
Insulating material	PBT
Inflammability class acc. to UL 94	V0

Accessories

Item	Designation	Description
1734401	CR-MSTB	Coding section, inserted into the recess in the header or the inverted plug, red insulating material

Drawings

Drilling diagram

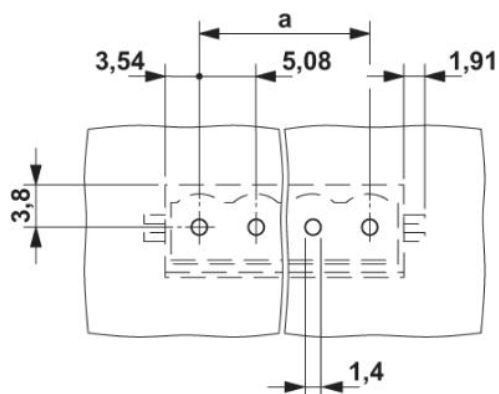

Dimensioned drawing

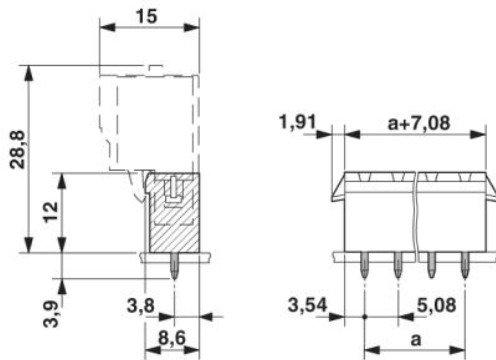

Address

PHOENIX CONTACT GmbH & Co. KG
Flachsmarktstr. 8
32825 Blomberg, Germany
Phone +49 5235 3 00
Fax +49 5235 3 41200
<http://www.phoenixcontact.com>



© 2009 Phoenix Contact
Technical modifications reserved;