

MVSTBW 2,5 HC/12-STF

Order No.: 1913057

The figure shows a 10-position version of the product



<http://eshop.phoenixcontact.de/phoenix/treeViewClick.do?UID=1913057>

Plug component, Nominal current: 16 A, Nom. voltage: 250 V, Pitch: 5 mm, Number of positions: 12, Connection type: Screw connection, Color: green

Commercial data	
EAN	4017918191764
Pack	50 pcs.
Customs tariff	85366990
Weight/Piece	0.02784 KG
Catalog page information	Page 351 (CC-2009)

Product notes

WEEE/RoHS-compliant since: 01/01/2003



<http://www.download.phoenixcontact.com>
Please note that the data given here has been taken from the online catalog. For comprehensive information and data, please refer to the user documentation. The General Terms and Conditions of Use apply to Internet downloads.

Accessories

Item	Designation	Description
Marking		
0804183	SK 5/3,8:FORTL.ZAHLEN	Marker card, printed horizontally, self-adhesive, 12 identical decades marked 1-10, 11-20 etc. up to 91-(99)100, sufficient for 120 terminal blocks

0805072	SK 5/3,8:SO	Marker card, special printing, self-adhesive, labeled acc. to customer requirements, 12 identical marker strips per card, max. 25-position labeling per strip, color: white
0805409	SK 5/3,8:UNBEDRUCKT	Marker cards, unprinted, with pitch divisions, self-adhesive, 10-section marker strips, 12 strips per card, can be labeled with the M-PEN
0803906	SK U/3,8 WH:UNBEDRUCKT	Unprinted marker cards, DIN A4 format, pitch as desired, self-adhesive, with 40 stamped marker strips, 185 mm strip length, can be labeled with the CMS system or manually with the M-PEN

Plug/Adapter

1734634	CP-MSTB	Keying profile, is inserted into the slot on the plug or inverted header, red insulating material
---------	---------	---

Tools

1205053	SZS 0,6X3,5	Screwdriver, bladed, matches all screw terminal blocks up to 4.0 mm ² connection cross section, blade: 0.6 x 3.5 mm, without VDE approval
---------	-------------	--

Drawings

Diagram

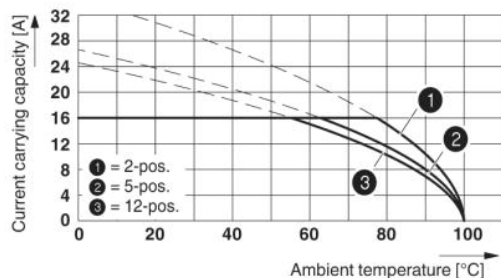

Derating curve for: MVSTBR 2,5 HC/...-ST with MSTBVA 2,5 HC/...-G

Dimensioned drawing

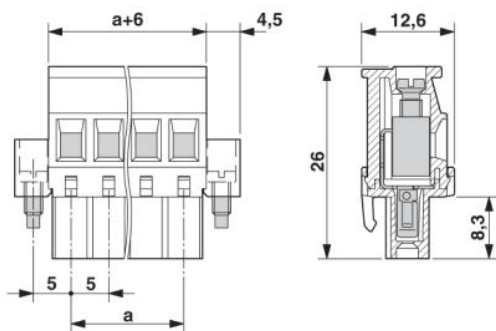

Address

PHOENIX CONTACT GmbH & Co. KG
Flachsmarktstr. 8
32825 Blomberg, Germany
Phone +49 5235 3 00
Fax +49 5235 3 41200
<http://www.phoenixcontact.com>



© 2009 Phoenix Contact
Technical modifications reserved;