

DFK-PC 6-16/ 9-GF-10,16

Order No.: 1701605

The figure shows a 5-pos. version of the product

<http://eshop.phoenixcontact.de/phoenix/treeViewClick.do?UID=1701605>

Header, Nominal current: 76 A, Nom. voltage: 1000 V, Pitch: 10.16 mm, Number of positions: 9, Color: green, Assembly: Soldering

Commercial data

EAN	4046356030670
Pack	10 pcs.
Customs tariff	85366990
Weight/Piece	0.05065 KG
Catalog page information	Page 429 (CC-2009)

Product notes

WEEE/RoHS-compliant since:
11/25/2004

<http://www.download.phoenixcontact.com>
Please note that the data given here has been taken from the online catalog. For comprehensive information and data, please refer to the user documentation. The General Terms and Conditions of Use apply to Internet downloads.

Technical data

Dimensions / positions

Pitch	10.16 mm
Number of positions	9

Technical data

Insulating material group	I
---------------------------	---

Rated surge voltage (III/3)	8 kV
Rated surge voltage (III/2)	8 kV
Rated surge voltage (II/2)	6 kV
Rated voltage (III/2)	1000 V
Rated voltage (II/2)	1000 V
Connection in acc. with standard	EN-VDE
Nominal current I_N	76 A
Nominal voltage U_N	1000 V
Maximum load current	76 A
Insulating material	PA
Inflammability class acc. to UL 94	V0

Drawings

Drilling diagram

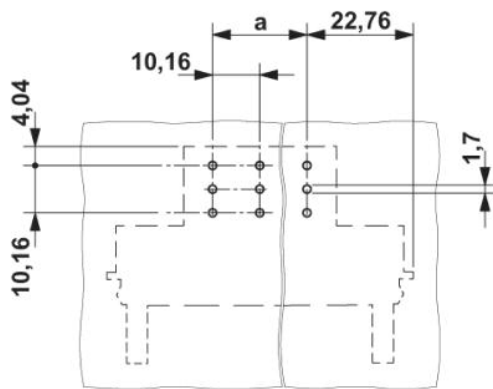

Diagram

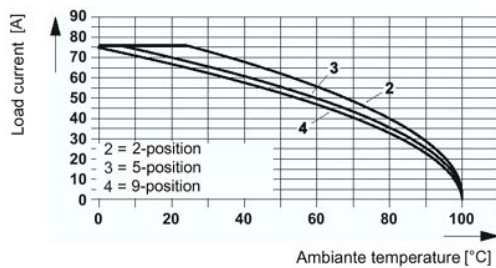

The illustration shows the derating curve for plugs DFK-PC(V) 6-16/...-G(F)(U)-(SH)-10,16 in combination with header PC 16/...-ST(F)-(SH)-10,16.

Dimensioned drawing

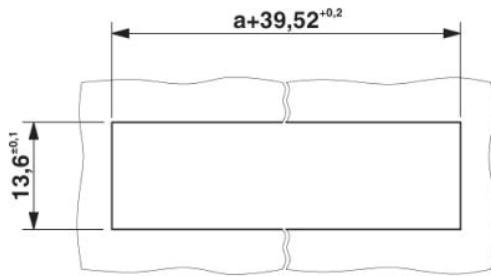

Sheet metal cutout for snap-on.

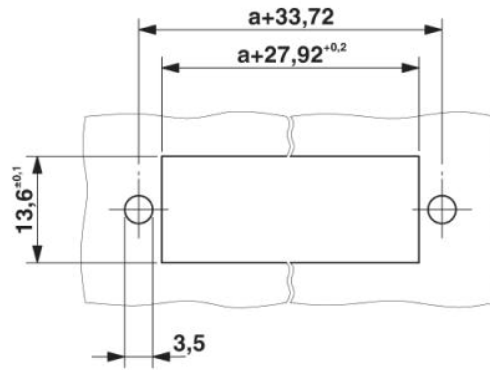

Sheet metal cutout for screw connection.

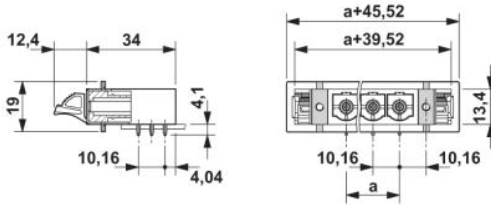

Address

PHOENIX CONTACT GmbH & Co. KG
Flachsmarktstr. 8
32825 Blomberg, Germany
Phone +49 5235 3 00
Fax +49 5235 3 41200
<http://www.phoenixcontact.com>



© 2009 Phoenix Contact
Technical modifications reserved;