

## DFK-PC 6-16/ 7-GF-10,16

Order No.: 1701582

The figure shows a 5-pos. version of the product

<http://eshop.phoenixcontact.de/phoenix/treeViewClick.do?UID=1701582>

Header, Nominal current: 76 A, Nom. voltage: 1000 V, Pitch: 10.16 mm, Number of positions: 7, Color: green, Assembly: Soldering

### Commercial data

EAN	4046356030656
Pack	10 pcs.
Customs tariff	85366990
Weight/Piece	0.04079 KG
Catalog page information	Page 429 (CC-2009)

### Product notes

WEEE/RoHS-compliant since:  
11/25/2004

<http://www.download.phoenixcontact.com>  
Please note that the data given here has been taken from the online catalog. For comprehensive information and data, please refer to the user documentation. The General Terms and Conditions of Use apply to Internet downloads.

### Technical data

#### Dimensions / positions

Pitch	10.16 mm
Number of positions	7

#### Technical data

Insulating material group	I
---------------------------	---

Rated surge voltage (III/3)	8 kV
Rated surge voltage (III/2)	8 kV
Rated surge voltage (II/2)	6 kV
Rated voltage (III/2)	1000 V
Rated voltage (II/2)	1000 V
Connection in acc. with standard	EN-VDE
Nominal current $I_N$	76 A
Nominal voltage $U_N$	1000 V
Maximum load current	76 A
Insulating material	PA
Inflammability class acc. to UL 94	V0

## Drawings

### Drilling diagram

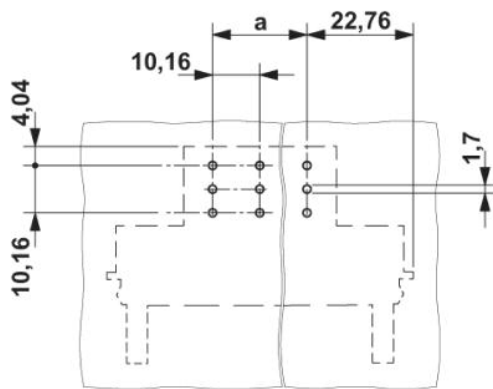

### Diagram

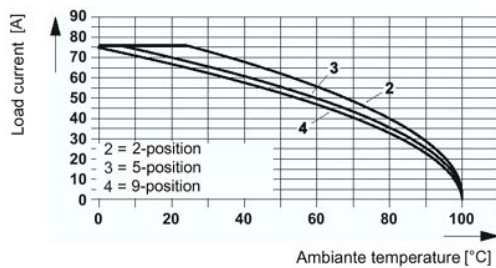

The illustration shows the derating curve for plugs DFK-PC(V) 6-16/...-G(F)(U)-(SH)-10,16 in combination with header PC 16/...-ST(F)-(SH)-10,16.

Dimensioned drawing

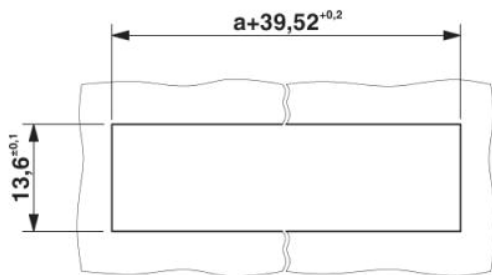

Sheet metal cutout for snap-on.

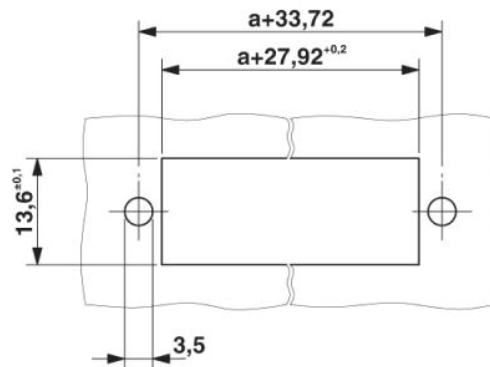

Sheet metal cutout for screw connection.

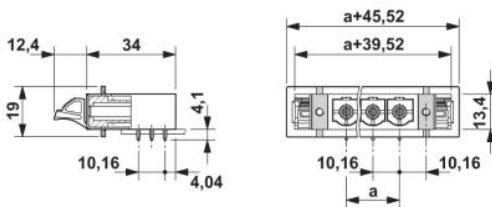

**Address**

PHOENIX CONTACT GmbH & Co. KG  
Flachsmarktstr. 8  
32825 Blomberg, Germany  
Phone +49 5235 3 00  
Fax +49 5235 3 41200  
<http://www.phoenixcontact.com>



© 2009 Phoenix Contact  
Technical modifications reserved;