

**SAC-5P-M12MS/1,5-PUR/M12FR-3L**

Order No.: 1694651

<http://eshop.phoenixcontact.de/phoenix/treeViewClick.do?UID=1694651>

Sensor/actuator cable, 5-pos., PUR halogen-free black, straight M12 plug, on angled M12 socket, with three LEDs, cable length: 1.5 m

**Commercial data**

EAN	4017918459246
Pack	1 pcs.
Customs tariff	85444290
Weight/Piece	0.0727 KG
Catalog page information	Page 87 (PC-2009)

**Product notes**

WEEE/RoHS-compliant since:  
11/17/2006



<http://www.download.phoenixcontact.com>  
Please note that the data given here has been taken from the online catalog. For comprehensive information and data, please refer to the user documentation. The General Terms and Conditions of Use apply to Internet downloads.

**Technical data****General data**

Nominal current $I_N$	4 A
Nominal voltage $U_N$	24 V
Number of positions	5
Volume resistance	$\leq 5 \text{ m}\Omega$
Insulation resistance	$\geq 100 \text{ M}\Omega$

Length of cable	1.5 m
Ambient temperature (operation)	-25 °C ... 90 °C (plug/socket)
	-40 °C ... 80 °C (cable, fixed installation)
	-5 °C ... 80 °C (cable, flexible installation)

#### General characteristics

Coding	A - standard
Inflammability class acc. to UL 94	HB
Surge voltage category	II
Pollution degree	3
Degree of protection	IP65/IP68/IP69K
Contact material	CuSn
Contact surface material	Ni/Au
Contact carrier material	TPU GF
Material of grip body	TPU, hardly inflammable, self-extinguishing
Material, knurls	Zinc die-cast, (nickel-plated)
Sealing material	NBR
Status display	3 LEDs

#### Conductor data

Cable type	PUR halogen-free black
Conductor cross section	0.34 mm <sup>2</sup>
AWG signal line	22
Conductor structure, signal line	42x 0.10 mm
Core diameter including insulation	1.27 mm ±0.05 mm
External cable diameter	5.00 mm
Wire colors	brown, blue, white, black, green/yellow
External sheath, color	Black-gray RAL 7021
Outer sheath, material	PUR
Conductor material	Bare Cu litz wires
Cable weight	35 kg/km
Number of bending cycles	4000000
Bending radius	50 mm
Traversing path	10 m
Traversing rate	3 m/s
Acceleration	10 m/s <sup>2</sup>

Special properties	Flexible cable conduit capable
	Silicone-free
	Free of substances which would hinder coating with paint or varnish
Flame resistance	As per UL-Style 20549
Freedom from halogen	As per DIN VDE 0472 part 815
Resistance to oil	complying with DIN EN 60811-2-1
Other resistance	Highly resistant to acids, alkaline solutions and solvents
	hydrolysis and microbe resistant

**Drawings**

Dimensioned drawing

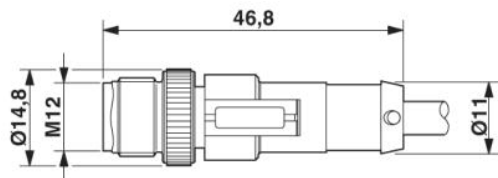

M12 x 1 male connector, straight

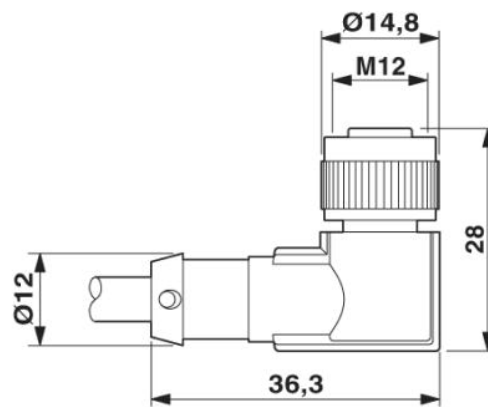

M12 x 1 female connector, angled

Circuit diagram

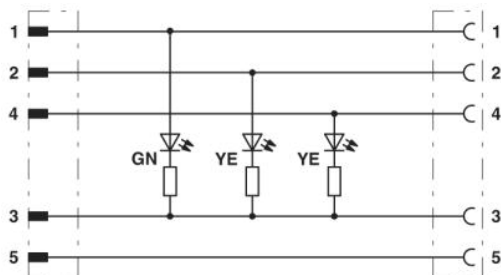

Contact assignment of M12 connectors / sockets with 3 LEDs

Schematic diagram

---

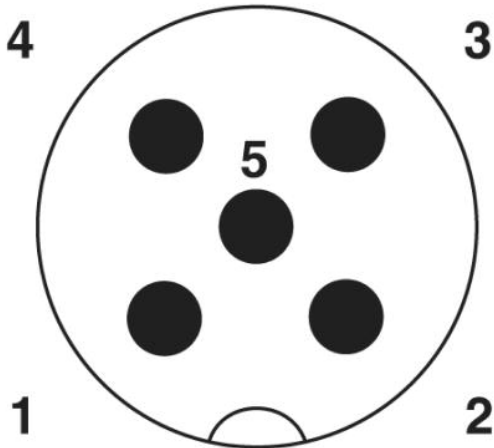

Pin assignment M12 male connector, 5-pos., A-coded, male side

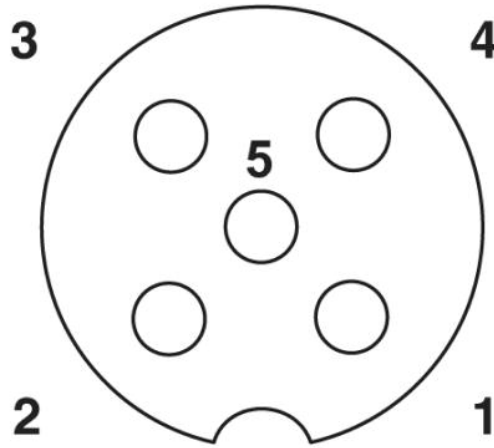

Pin assignment M12 socket, 5-pos., A-coded, socket side view

**Address**

PHOENIX CONTACT GmbH & Co. KG  
Flachmarktstr. 8  
32825 Blomberg, Germany  
Phone +49 5235 3 00  
Fax +49 5235 3 41200  
<http://www.phoenixcontact.com>



© 2009 Phoenix Contact  
Technical modifications reserved;