

SACC-DSIV-MS-8CON-L180-THR SH

Order No.: 1557578

<http://eshop.phoenixcontact.de/phoenix/treeViewClick.do?UID=1557578>

Sensor/actuator flush-type connector, plug, 8-pos., M12 SPEEDCON, A-coded, shielded, rear/screw mounting with M12 thread, with straight THR solder connection

Commercial data

EAN	4046356284899
Pack	60 pcs.
Customs tariff	85366990
Weight/Piece	0.0105 KG
Catalog page information	Page 32 (PC-2009)

Product notes

WEEE/RoHS-compliant since:
04/13/2007



<http://www.download.phoenixcontact.com>
Please note that the data given here has been taken from the online catalog. For comprehensive information and data, please refer to the user documentation. The General Terms and Conditions of Use apply to Internet downloads.

Technical data**General data**

Nominal current I_N	2 A
Nominal voltage U_N	30 V
Number of positions	8
Volume resistance	$\leq 3 \text{ m}\Omega$

Insulation resistance	≥ 100 MΩ
Ambient temperature (operation)	-25 °C ... 85 °C (plug/socket)

General characteristics

Coding	A - standard
Inflammability class acc. to UL 94	V0
Surge voltage category	II
Pollution degree	3
Degree of protection	IP67
Contact material	CuZn
Contact surface material	Au
Contact carrier material	PA 66
Material, knurls	Zinc die-cast, (nickel-plated)
Sealing material	FKM / EPDM
Type of connection	THR solder connection
Status display	No

Drawings

Drilling diagram

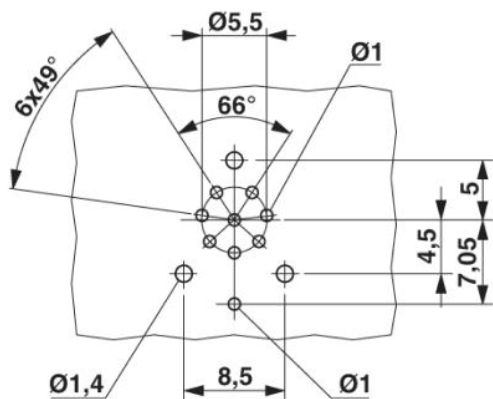

Dimensioned drawing

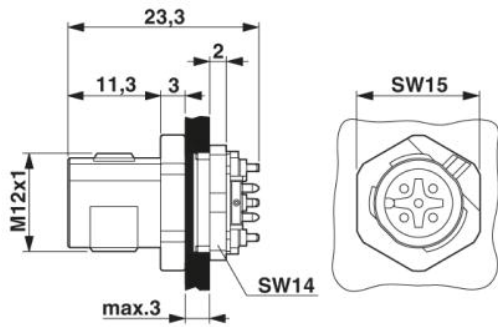

M12 flush-type connector

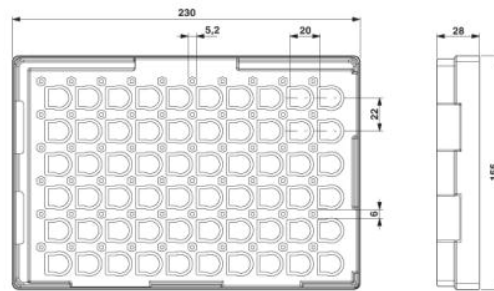

THR tray packaging

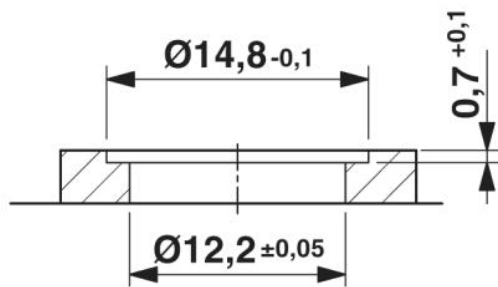

Housing cut-out for two-part M12 flush-type connectors with THR and wave soldering connection, version 1

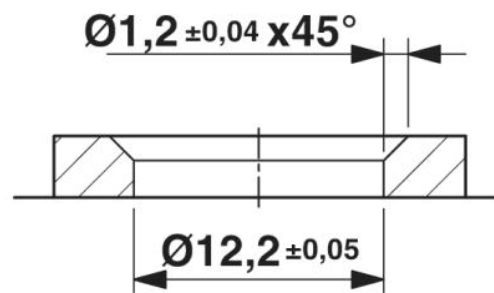

Housing cut-out for two-part M12 flush-type connectors with THR and wave soldering connection, version 2

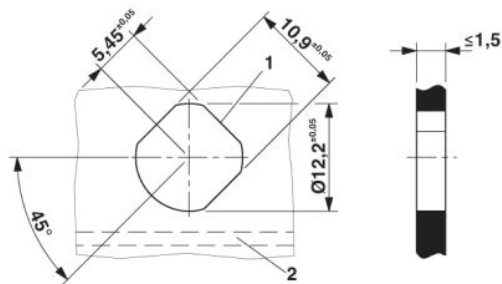

Housing cutout for M12 fastening thread, mounting panel with feed-through hole (alternative with surface as protection against rotation)

Schematic diagram

Pin assignment M12 plug, 8-pos., view plug side

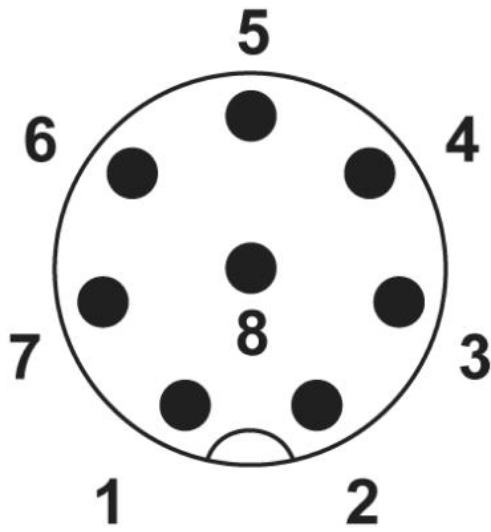

Address

PHOENIX CONTACT GmbH & Co. KG
Flachmarktstr. 8
32825 Blomberg, Germany
Phone +49 5235 3 00
Fax +49 5235 3 41200
<http://www.phoenixcontact.com>



© 2009 Phoenix Contact
Technical modifications reserved;