

SAC-12P- 3,0-PVC/FR SCO

Order No.: 1554908

<http://eshop.phoenixcontact.de/phoenix/treeViewClick.do?UID=1554908>

Sensor/actuator cable, 12-pos., black PVC, angled M12 SPEEDCON socket on the free conductor end, length: 3.0 m

Commercial data

EAN	4046356176514
Pack	1 pcs.
Customs tariff	85444290
Weight/Piece	0.1639 KG
Catalog page information	Page 96 (PC-2009)

Product notes

WEEE/RoHS-compliant since:
04/13/2007



<http://www.download.phoenixcontact.com>
Please note that the data given here has been taken from the online catalog. For comprehensive information and data, please refer to the user documentation. The General Terms and Conditions of Use apply to Internet downloads.

Technical data

General data

Nominal current I_N	1.5 A
Nominal voltage U_N	30 V
Number of positions	12
Volume resistance	$\leq 5 \text{ m}\Omega$
Insulation resistance	$\geq 100 \text{ M}\Omega$

Length of cable	3 m
Ambient temperature (operation)	-25 °C ... 90 °C (plug/socket)
	-25 °C ... 80 °C (cable, fixed installation)
	-5 °C ... 80 °C (cable, flexible installation)

General characteristics

Coding	A - standard
Inflammability class acc. to UL 94	HB
Surge voltage category	II
Pollution degree	3
Degree of protection	IP65/IP68/IP69K
Contact material	CuZn
Contact surface material	Ni/Au
Contact carrier material	TPU GF
Material of grip body	TPU, hardly inflammable, self-extinguishing
Material, knurls	Zinc die-cast, (nickel-plated)
Sealing material	NBR
Status display	No

Conductor data

Cable type	PVC black
Conductor cross section	0.14 mm ²
AWG signal line	26
Conductor structure, signal line	18x 0.10 mm
External cable diameter	5.80 mm
Wire colors	Color-coded DIN 47100
External sheath, color	black

Drawings

Dimensioned drawing

M12-SPEEDCON socket, angled

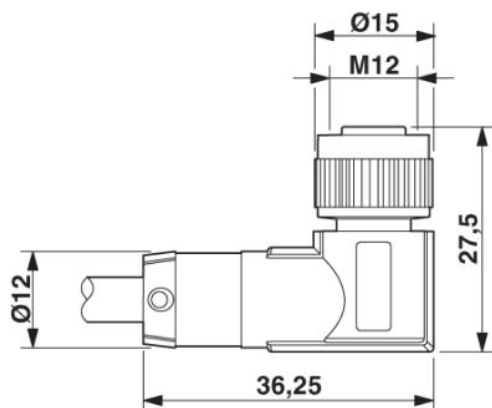

Circuit diagram

Contact assignment of the M12 socket



Schematic diagram

Pin assignment M12, 12-pos., female side view

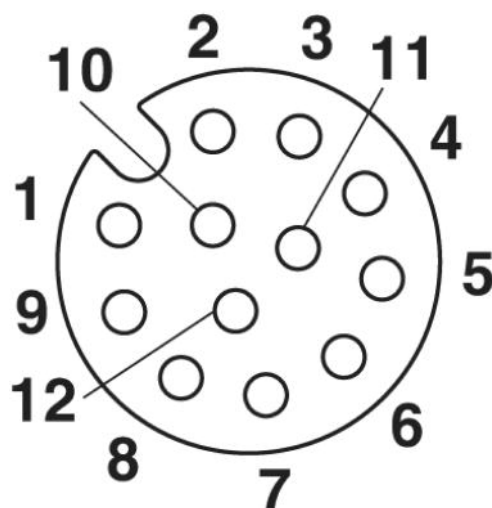

Address

PHOENIX CONTACT GmbH & Co. KG
Flachsmarktstr. 8
32825 Blomberg, Germany
Phone +49 5235 3 00
Fax +49 5235 3 41200
<http://www.phoenixcontact.com>



© 2009 Phoenix Contact
Technical modifications reserved;