

SACC-DSI-MS-12CON-PG9/0,5 SCO

Order No.: 1430459

<http://eshop.phoenixcontact.de/phoenix/treeViewClick.do?UID=1430459>

Sensor/actuator flush-type connector, 12-pos., M12 SPEEDCON, rear/screw mounting with Pg9 thread, with 0.5 m halogen-free TPE litz wire, 12 x 0.14 mm²

Commercial data

EAN	4046356325813
Pack	1 pcs.
Customs tariff	85444290
Weight/Piece	0.0286 KG
Catalog page information	Page 27 (PC-2009)

Product notes

WEEE/RoHS-compliant since:
10/29/2007



<http://www.download.phoenixcontact.com>
Please note that the data given here has been taken from the online catalog. For comprehensive information and data, please refer to the user documentation. The General Terms and Conditions of Use apply to Internet downloads.

Technical data**General data**

Nominal current I _N	1.5 A
Nominal voltage U _N	30 V
Number of positions	12
Volume resistance	≤ 3 mΩ

Insulation resistance	≥ 100 MΩ
Length of cable	0.5 m
Ambient temperature (operation)	-25 °C ... 85 °C (plug/socket)
	-25 °C ... 90 °C (cable, fixed installation)

General characteristics

Coding	A - standard
Inflammability class acc. to UL 94	V0
Surge voltage category	II
Pollution degree	3
Degree of protection	IP67
Contact material	CuZn
Contact surface material	Au
Contact carrier material	PA 66
Material, knurls	Zinc die-cast, (nickel-plated)
Sealing material	NBR
Mounting type	Rear mounting, Pg9 thread with flat nut
Type of connection	Individual wires
Status display	No

Conductor data

Cable type	TPE litz wire
Conductor cross section	0.14 mm ²
AWG signal line	26
Wire colors	Color-coded DIN 47100
Material conductor insulation	TPE

Drawings

Dimensioned drawing

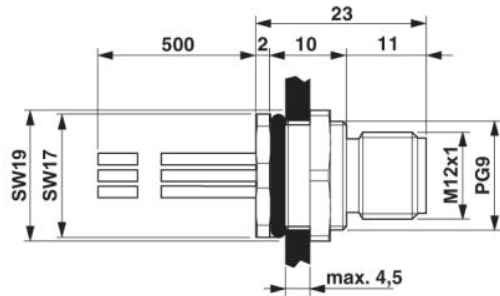

M12 flush-type connector

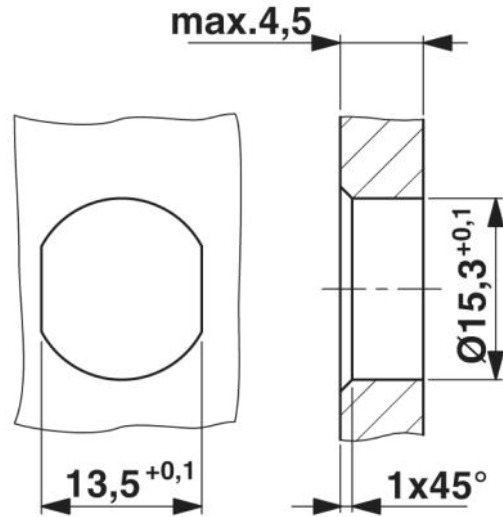

Housing cutout for Pg9 fastening thread, mounting panel with feed-through hole (alternatively with surface as protection against rotation)

Circuit diagram

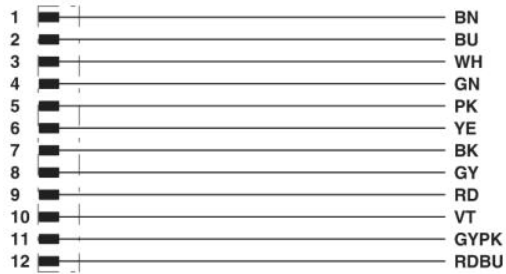

Contact assignment of the M12 plug

Schematic diagram

Pin assignment M12 male connector, 12-pos., male side view

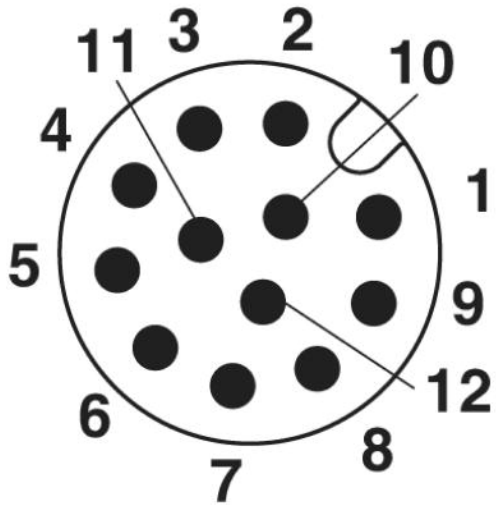

Address

PHOENIX CONTACT GmbH & Co. KG
Flachsmarktstr. 8
32825 Blomberg, Germany
Phone +49 5235 3 00
Fax +49 5235 3 41200
<http://www.phoenixcontact.com>



© 2009 Phoenix Contact
Technical modifications reserved;