

Printed-circuit board connector - IPC 5/12-STGCL-7,62 - 1718368

Please be informed that the data shown in this PDF Document is generated from our Online Catalog. Please find the complete data in the user's documentation. Our General Terms of Use for Downloads are valid (<http://phoenixcontact.com/download>)



PCB connector, nominal current: 41 A, rated voltage (III/2): 1000 V, number of positions: 12, pitch: 7.62 mm, connection method: Screw connection with tension sleeve, color: green, contact surface: Tin

The figure shows a 5-pos. version of the product

Your advantages

- ✓ Well-known connection principle allows worldwide use
- ✓ Low temperature rise, thanks to maximum contact force
- ✓ Allows connection of two conductors
- ✓ Inverted connector with pin contacts for touch-proof device outputs or free-hanging cable/cable connections
- ✓ The automatically locking Click and Lock system prevents accidental disconnection
- ✓ 600 V UL approval in the smallest of dimensions

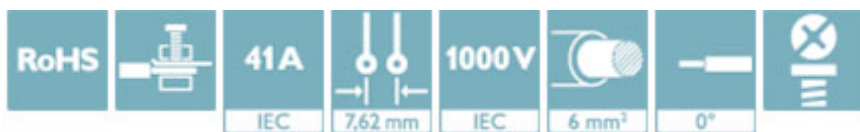

Key Commercial Data

Packing unit	50 pc
GTIN	
GTIN	4046356175371

Technical data

Dimensions

Length [l]	36.55 mm
Width [w]	94.24 mm
Height [h]	22.9 mm
Pitch	7.62 mm
Dimension a	83.82 mm

General

Range of articles	IPC 5/...-STGCL
Number of positions	12
Connection method	Screw connection with tension sleeve

Printed-circuit board connector - IPC 5/12-STGCL-7,62 - 1718368

Technical data

General

Insulating material group	I
Rated surge voltage (III/3)	8 kV
Rated surge voltage (III/2)	8 kV
Rated surge voltage (II/2)	6 kV
Rated voltage (III/3)	1000 V
Rated voltage (III/2)	1000 V
Rated voltage (II/2)	1000 V
Connection in acc. with standard	EN-VDE
Nominal current I_N	41 A
Nominal cross section	6 mm ²
Maximum load current	41 A
Insulating material	PA
Flammability rating according to UL 94	V0
Stripping length	10 mm
Screw thread	M3
Tightening torque, min	0.7 Nm
Tightening torque max	0.8 Nm

Connection data

Conductor cross section solid min.	0.2 mm ²
Conductor cross section solid max.	10 mm ²
Conductor cross section flexible min.	0.2 mm ²
Conductor cross section flexible max.	6 mm ²
Conductor cross section flexible, with ferrule without plastic sleeve min.	0.25 mm ²
Conductor cross section flexible, with ferrule without plastic sleeve max.	6 mm ²
Conductor cross section flexible, with ferrule with plastic sleeve min.	0.25 mm ²
Conductor cross section flexible, with ferrule with plastic sleeve max.	4 mm ²
Conductor cross section AWG min.	24
Conductor cross section AWG max.	10
2 conductors with same cross section, solid min.	0.2 mm ²
2 conductors with same cross section, solid max.	2.5 mm ²
2 conductors with same cross section, stranded min.	0.2 mm ²
2 conductors with same cross section, stranded max.	4 mm ²
2 conductors with same cross section, stranded, ferrules without plastic sleeve, min.	0.25 mm ²
2 conductors with same cross section, stranded, ferrules without plastic sleeve, max.	1.5 mm ²
2 conductors with same cross section, stranded, TWIN ferrules with plastic sleeve, min.	0.25 mm ²
2 conductors with same cross section, stranded, TWIN ferrules with plastic sleeve, max.	2.5 mm ²
Minimum AWG according to UL/CUL	24

Printed-circuit board connector - IPC 5/12-STGCL-7,62 - 1718368

Technical data

Connection data

Maximum AWG according to UL/CUL	8
---------------------------------	---

Standards and Regulations

Connection in acc. with standard	EN-VDE
	CUL
Flammability rating according to UL 94	V0

Environmental Product Compliance

REACH SVHC	Lead 7439-92-1
China RoHS	Environmentally Friendly Use Period = 50
	For details about hazardous substances go to tab "Downloads", Category "Manufacturer's declaration"

Drawings

Schematic diagram

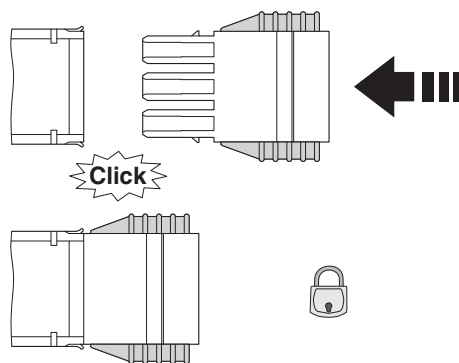

Diagram

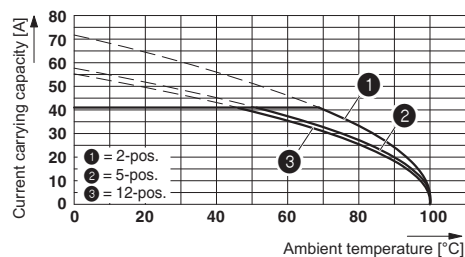

Derating curve for: IPC 5/...-ST-7,62 with PC 5/...-ST-7,62
Conductor cross section = 10 mm²

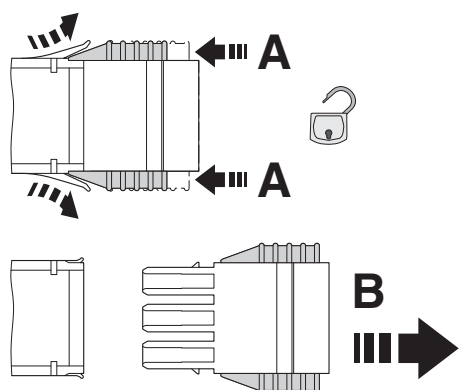

Click and Lock system method of operation

Printed-circuit board connector - IPC 5/12-STGCL-7,62 - 1718368

Diagram

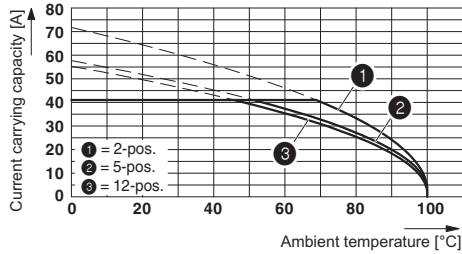

Derating curve for: IPC 5/...-ST-7,62 with IPC 5/...-G-7,62
Conductor cross section = 10 mm²

Diagram

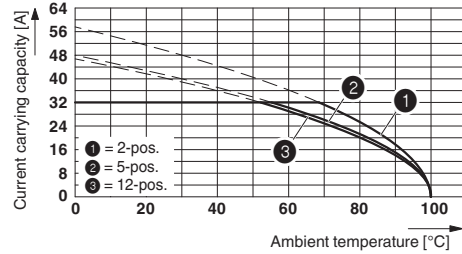

Derating curve for: IPC 5/...-ST-7,62 with IPC 5/...-G-7,62
Conductor cross section 6 mm²

Dimensional drawing

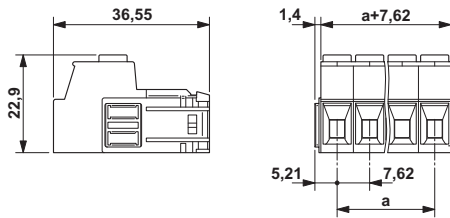

Approvals

Approvals

Approvals

EAC / cULus Recognized

Ex Approvals

Approval details

EAC		B.01742
-----	--	---------

cULus Recognized		http://database.ul.com/cgi-bin/XYV/template/LISEXT/1FRAME/index.htm	E60425-19920722
	B	C	
Nominal voltage UN	600 V	600 V	
Nominal current IN	41 A	41 A	

Printed-circuit board connector - IPC 5/12-STGCL-7,62 - 1718368

Approvals

	B	C
mm ² /AWG/kcmil	24-8	24-8

Phoenix Contact 2019 © - all rights reserved
<http://www.phoenixcontact.com>

PHOENIX CONTACT GmbH & Co. KG

Flachsmarktstr. 8

32825 Blomberg

Germany

Tel. +49 5235 300

Fax +49 5235 3 41200

<http://www.phoenixcontact.com>