

Sample set - SAMPLE SPT-THR 1,5/ 7-V-5,0 - 1838063

Please be informed that the data shown in this PDF Document is generated from our Online Catalog. Please find the complete data in the user's documentation. Our General Terms of Use for Downloads are valid (<http://phoenixcontact.com/download>)



PCB terminal block, nominal current: 13.5 A, nom. voltage: 320 V, pitch: 5 mm, number of positions: 7, connection method: Push-in spring connection, mounting: THR soldering, conductor/PCB connection direction: 90 °, color: black. SAMPLE set with 5 items in belt section. When used as part of soldering process, please use items without SAMPLE marking

Your advantages

- ✓ Time saving push-in connection, tools not required
- ✓ Defined contact force ensures that contact remains stable over the long term
- ✓ Intuitive use through colour coded actuation lever
- ✓ Designed for integration into the SMT soldering process
- ✓ Operation and conductor connection from one direction enable integration into front of device
- ✓ Quick and convenient testing using integrated test option
- ✓ Two solder pins reduce the mechanical strain on the soldering spots

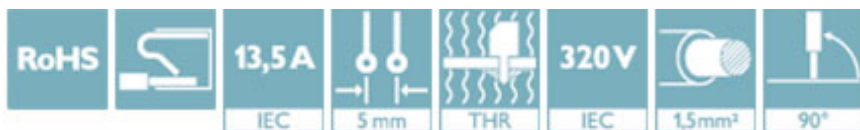

Key Commercial Data

Packing unit	1
GTIN	
GTIN	4055626039251
Custom tariff number	85369010

Technical data

Item properties

Brief article description	PCB terminal block
Range of articles	SPT 1,5/..-V-THR
Pitch	5 mm
Number of positions	7
Connection method	Push-in spring connection
Mounting type	THR soldering
Pin layout	Linear double pinning
Number of levels	1

Sample set - SAMPLE SPT-THR 1,5/ 7-V-5,0 - 1838063

Technical data

Electrical parameters

Rated current	13.5 A
Rated insulation voltage (III/2)	320 V
Rated surge voltage (III/2)	4 kV

Connection capacity

Conductor cross section solid	0.2 mm ² ... 1.5 mm ²
Conductor cross section flexible	0.2 mm ² ... 1.5 mm ²
Conductor cross section AWG / kcmil	24 ... 16
Conductor cross section flexible, with ferrule without plastic sleeve	0.2 mm ² ... 1.5 mm ²
Conductor cross section, flexible, with ferrule, with plastic sleeve	0.2 mm ² ... 0.75 mm ²
Stripping length	8 mm

Material data - contact

Note	WEEE/RoHS-compliant, free of whiskers according to IEC 60068-2-82/ JEDEC JESD 201
Contact material	Cu alloy
Surface characteristics	hot-dip tin-plated
Metal surface terminal point (top layer)	Tin (4 - 8 µm Sn)
Metal surface soldering area (top layer)	Tin (4 - 8 µm Sn)

Material data - housing

Insulating material	LCP
Insulating material group	IIIa
CTI according to IEC 60112	175
Flammability rating according to UL 94	V0

Dimensions for the product

Length [l]	7.7 mm
Width [w]	34 mm
Height [h]	15.6 mm
Pitch	5 mm
Height (without solder pin)	13.6 mm
Solder pin [P]	2 mm
Pin spacing	5.5 mm
Pin dimensions	0.7 x 0.3 mm
Dimension a	30 mm

Dimensions for PCB design

Hole diameter	1.1 mm
Pin spacing	5.5 mm

Packaging information

Type of packaging	packed in cardboard
Pieces per package	5

Sample set - SAMPLE SPT-THR 1,5/ 7-V-5,0 - 1838063

Technical data

Packaging information

Denomination packing units	Pcs.
----------------------------	------

Ambient conditions

Ambient temperature (storage/transport)	-40 °C ... 70 °C
Ambient temperature (assembly)	-5 °C ... 100 °C
Ambient temperature (operation)	-40 °C

Termination and connection method

Connection test	IEC 60998-2-2:2002-12
Test result	Test passed

Pull-out test

Pull-out test	IEC 60998-2-2:2002-12
	Test passed
Conductor cross section / conductor type / tensile force	0.2 mm ² / solid / > 10 N
	0.2 mm ² / flexible / > 10 N
	1.5 mm ² / solid / > 40 N
	1.5 mm ² / flexible / > 40 N

Mechanical tests according to standard

Test specification	IEC 60998-2-2 (in parts)
--------------------	--------------------------

Electrical tests

Rated current	13.5 A
Rated insulation voltage (III/2)	320 V
Rated surge voltage (III/2)	4 kV

Air clearances and creepage distances

Insulating material group	IIIa
Voltage	250 V
Rated insulation voltage (III/3)	250 V
Rated insulation voltage (III/2)	320 V
Rated insulation voltage (II/2)	500 V
Rated surge voltage (III/3)	4 kV
Rated surge voltage (III/2)	4 kV
Rated surge voltage (II/2)	4 kV

Current carrying capacity / derating curves

Specification	IEC 60998-2-2 (in parts)
---------------	--------------------------

Vibration test

Resistance to ageing, to humidity conditions, to ingress of solid objects and to harmful ingress of water	Test passed IEC 60998-1:2002-12 168 h/100°C 48 h/30 °C/92 %
Test result	Test passed
Test specification	IEC 60998-1:2002-12
Dry heat	168 h/100°C

Sample set - SAMPLE SPT-THR 1,5/ 7-V-5,0 - 1838063

Technical data

Vibration test

Humid heat	48 h/30 °C/92 %
------------	-----------------

Resistance to ageing, humidity and penetration of solids

Test result	Test passed
Test specification	IEC 60998-1:2002-12
Dry heat	168 h/100°C
Humid heat	48 h/30 °C/92 %

Standards and Regulations

Flammability rating according to UL 94	V0
--	----

Environmental Product Compliance

China RoHS	Environmentally friendly use period: unlimited = EFUP-e
	No hazardous substances above threshold values

Drawings

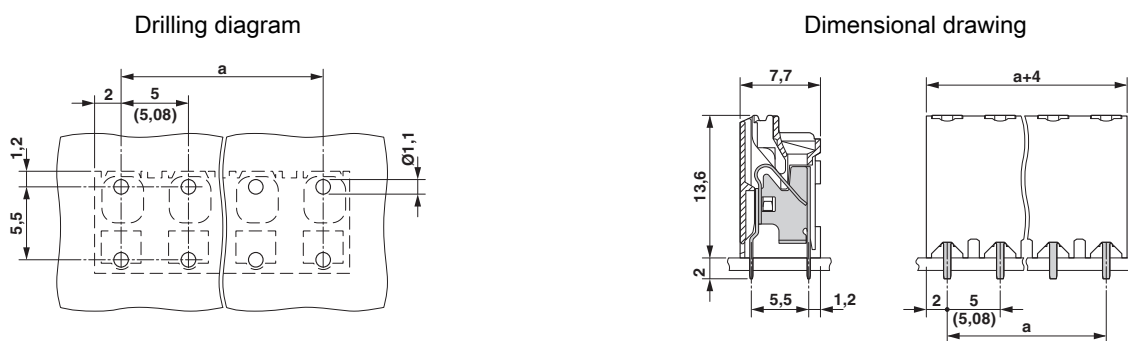

Classifications

eCl@ss

eCl@ss 5.1	27261100
eCl@ss 6.0	27261100
eCl@ss 7.0	27440401
eCl@ss 8.0	27440401
eCl@ss 9.0	27440401

ETIM

ETIM 5.0	EC002643
ETIM 6.0	EC002643

UNSPSC

UNSPSC 13.2	39121432
-------------	----------

Sample set - SAMPLE SPT-THR 1,5/ 7-V-5,0 - 1838063

Approvals

Approvals

Approvals

EAC

Ex Approvals

Approval details

EAC		B.01742
-----	--	---------

Accessories

Accessories

Connector

Ferrule - A 0,5 - 8 - 3202481



Ferrule, length: 8 mm, color: silver

Ferrule - A 0,75- 8 - 3202504



Ferrule, length: 8 mm, color: silver

Ferrule - A 1 - 8 - 3202517



Ferrule, length: 8 mm, color: silver

Sample set - SAMPLE SPT-THR 1,5/ 7-V-5,0 - 1838063

Accessories

Ferrule - AI 0,25- 8 YE - 3203037



Ferrule, sleeve length: 8 mm, length: 12.5 mm, color: yellow

Ferrule - AI 0,5 - 8 WH - 3200014



Ferrule, sleeve length: 8 mm, length: 14 mm, color: white

Ferrule - AI 0,5 - 8 WH -1000 - 3200881



Ferrule, sleeve length: 8 mm, length: 14 mm, color: white

Ferrule - AI 0,75- 8 GY - 3200519



Ferrule, sleeve length: 8 mm, length: 14 mm, color: gray

Ferrule - AI 0,75- 8 GY -1000 - 3200894



Ferrule, sleeve length: 8 mm, length: 14 mm, color: gray

Crimping tool

Sample set - SAMPLE SPT-THR 1,5/ 7-V-5,0 - 1838063

Accessories

Crimping pliers - CRIMPFOX 6 - 1212034



Crimping pliers, for ferrules without insulating collar according to DIN 46228 Part 1 and ferrules with insulating collar according to DIN 46228 Part 4, 0.25 mm² ... 6.0 mm², lateral entry, trapezoidal crimp

Screwdriver tools

Screwdriver - SZS 0,4X2,5 VDE - 1205037



Screwdriver, slot-headed, VDE insulated, size: 0.4 x 2.5 x 80 mm, 2-component grip, with non-slip grip