

Sensor/actuator cable - SAC-2P-SUSMS/ 0,6-PUR/SUSFS - 1410759

Please be informed that the data shown in this PDF Document is generated from our Online Catalog. Please find the complete data in the user's documentation. Our General Terms of Use for Downloads are valid (<http://phoenixcontact.com/download>)



Sensor/actuator cable, 2-position, PUR halogen-free, black-gray RAL 7021, Plug straight Superseal Clip locking, on Socket straight Superseal Clip locking, cable length: 0.6 m



Key Commercial Data

Packing unit	1 pc
GTIN	 4 046356 924474
GTIN	4046356924474
Weight per Piece (excluding packing)	48.000 g
Custom tariff number	85444290
Country of origin	Poland

Technical data

Dimensions

Length of cable	0.6 m
-----------------	-------

Ambient conditions

Ambient temperature (operation)	-20 °C ... 85 °C (Superseal)
Degree of protection	IP67

General

Rated current at 40°C	8 A
Rated voltage	24 V AC
	24 V DC
Number of positions	2
Color handle area	black
Insulation resistance	≥ 100 MΩ
Coding	A - standard
Status display	No
Protective circuit/component	unwired

Sensor/actuator cable - SAC-2P-SUSMS/ 0,6-PUR/SUSFS - 1410759

Technical data

Material

Flammability rating according to UL 94	HB
Contact material	CuZn (pin)/PhCuSn (socket)
Contact surface material	Nickel-plated
Contact carrier material	PA 6.6
Material of grip body	PA
Material, knurls	not available
Sealing material	Silicon

Standards and Regulations

Flammability rating according to UL 94	HB
--	----

Cable

Cable type	PUR halogen-free black
Cable type (abbreviation)	PUR
Cable abbreviation	Li9Y11Y
UL AWM style	20549 / 10493 (80°C/300 V)
Conductor cross section	2x 0.75 mm ² (Signal line)
AWG signal line	18
Conductor structure signal line	42x 0.15 mm
Core diameter including insulation	1.69 mm ±0.05 mm (Signal line)
Thickness, insulation	≥ 0.21 mm
Wire colors	brown, blue
Overall twist	2 wires, twisted
External sheath, color	black-gray RAL 7021
Outer sheath thickness	≥ 0.38 mm
External cable diameter D	4.8 mm ±0.15 mm
Minimum bending radius, fixed installation	5 x D
Minimum bending radius, flexible installation	10 x D
Number of bending cycles	4000000
Bending radius	48 mm
Traversing path	10 m
Traversing rate	3 m/s
Acceleration	10 m/s ²
Cable weight	33 kg/km
Outer sheath, material	PUR
Material conductor insulation	PP
Conductor material	Bare Cu litz wires
Insulation resistance	≥ 1 GΩ*km (at 20 °C)
Conductor resistance	≤ 26 Ω/km (at 20 °C)
Nominal voltage, cable	≤ 300 V AC
Test voltage, cable	≥ 3000 V AC (Spark test)
Special properties	flexible

Sensor/actuator cable - SAC-2P-SUSMS/ 0,6-PUR/SUSFS - 1410759

Technical data

Cable

	Flexible cable conduit capable
Flame resistance	according to UL 758/1581 (horizontal)
	in accordance with UL 758/1581 FT2
	according to DIN EN 60332-2-2
Halogen-free	in accordance with DIN VDE 0472 part 815
	in accordance with DIN EN 50267-2-1
Resistance to oil	According to DIN EN 60811-2-1, 168 h at 100°C
	According to UL 758, 168 h at 60°C
Other resistance	hydrolysis and microbe resistant
	partly UV-resistant in accordance with DIN EN ISO 4892-2-A
	Low adhesion
	abrasion-resistant
Ambient temperature (operation)	-40 °C ... 80 °C (cable, fixed installation)
	-25 °C ... 80 °C (cable, flexible installation)

Environmental Product Compliance

China RoHS	Environmentally friendly use period: unlimited = EFUP-e
	No hazardous substances above threshold values

Drawings

Schematic diagram

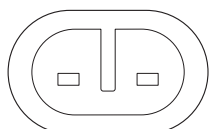

Super seal plug pin assignment, 2-pos.

Schematic diagram

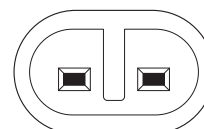

Super seal socket pin assignment, 2-pos.

Cable cross section

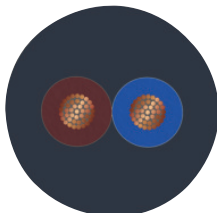

PUR halogen-free black [PUR]

Dimensional drawing

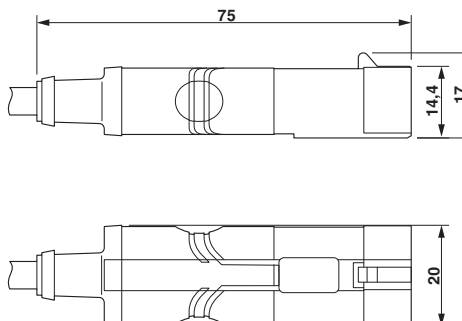

Superseal, plug, view from above and side

Sensor/actuator cable - SAC-2P-SUSMS/ 0,6-PUR/SUSFS - 1410759

Dimensional drawing

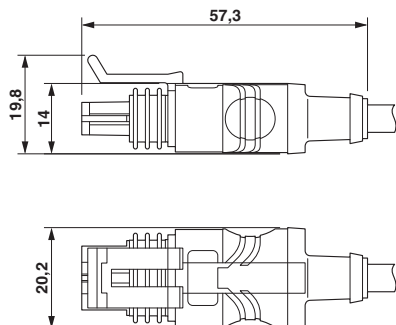

Circuit diagram

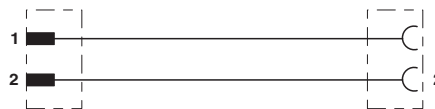

Contact assignment of the super seal plug to the super seal socket

Superseal, socket, view from above and side

Classifications

eCl@ss

eCl@ss 5.1	27061800
eCl@ss 6.0	27279200
eCl@ss 7.0	27279218
eCl@ss 8.0	27279218
eCl@ss 9.0	27060311

ETIM

ETIM 4.0	EC001855
ETIM 5.0	EC001855
ETIM 6.0	EC001855

UNSPSC

UNSPSC 13.2	31251501
-------------	----------

Accessories

Accessories

Conductor marking

Insert label - PABA WH/23 - 1013779



Insert label, Strip, white, unlabeled, can be labeled with: CMS-P1-PLOTTER, mounting type: thread on, cable diameter range: 1.5 - 35 mm, lettering field size: 23 x 4 mm

Sensor/actuator cable - SAC-2P-SUSMS/ 0,6-PUR/SUSFS - 1410759

Accessories

Insert label - PABA YE/23 - 1013782



Insert label, Strip, yellow, unlabeled, can be labeled with: CMS-P1-PLOTTER, mounting type: thread on, cable diameter range: 1.5 - 35 mm, lettering field size: 23 x 4 mm

Insert label - PABA WH/15 - 1013151



Insert label, Strip, white, unlabeled, can be labeled with: CMS-P1-PLOTTER, mounting type: thread on, cable diameter range: 0.6 - 50 mm, lettering field size: 15 x 4 mm

Insert label - PABA YE/15 - 1013698



Insert label, Strip, yellow, unlabeled, can be labeled with: CMS-P1-PLOTTER, mounting type: thread on, cable diameter range: 0.6 - 50 mm, lettering field size: 15 x 4 mm

Insert label - PABA RD/15 - 1013944



Insert label, Strip, red, unlabeled, can be labeled with: CMS-P1-PLOTTER, mounting type: thread on, cable diameter range: 0.6 - 50 mm, lettering field size: 15 x 4 mm

Corrugated pipe

Protective hose - WP-PA HF 13,0 BK - 3240681



Polyamide protective hose, inflammability class V0, UV resistant

Sensor/actuator cable - SAC-2P-SUSMS/ 0,6-PUR/SUSFS - 1410759

Accessories

Protective hose - WP-PA HF-HB 13,0 BK - 3240839



Polyamide protective hose, inflammability class HB, UV resistant

Cutting tools

Diagonal cutter - CUTFOX-S VDE - 1212207



Diagonal cutter for hard (piano wire) and soft wires, VDE 1000 V AC/1500 V DC tested

Marker carrier cable

Conductor marker carrier - PATG 2/15 - 1013038



Conductor marker carrier, transparent, unlabeled, mounting type: slide on, cable diameter range: 2 - 4 mm, lettering field size: 15 x 4 mm

Conductor marker carrier - PATG 3/15 - 1013041



Conductor marker carrier, transparent, unlabeled, mounting type: slide on, cable diameter range: 4 - 7 mm, lettering field size: 15 x 4 mm

Conductor marker carrier - PATG 4/15 - 1013054



Conductor marker carrier, transparent, unlabeled, mounting type: slide on, cable diameter range: 6 - 10 mm, lettering field size: 15 x 4 mm

Marker pen

Sensor/actuator cable - SAC-2P-SUSMS/ 0,6-PUR/SUSFS - 1410759

Accessories

Marker pen - B-STIFT - 1051993



Marker pen, for manual labeling of unprinted Zack strips, smear-proof and waterproof, line thickness 0.5 mm

Stripping tool

Stripping tool - WIREFOX SAC-1 - 1212757



Stripping pliers, for halogen-free sensor/actuator cables (SAC cables), with PUR and PVC insulation, from \varnothing of 3.2 to 4.4 mm, any stripping length

Stripping tool - WIREFOX SAC - 1212623



Stripping pliers, for halogen-free sensor/actuator cables (SAC cables), with PUR and PVC insulation, from \varnothing of 4.4 to 7 mm, any stripping length

Stripping tool - WIREFOX 10 - 1212150



Stripping tool, for cables and conductors from 0.02 - 10 mm², self-adjusting, stripping length of up to 18 mm, cutting capacity of up to 10 mm² stranded/1.5 mm² solid, replaceable stripping blade

Protective hose adapter - WP-CTA POM 13,0 BK - 1422884



Protective hose adapter, for corrugated hoses with a nominal size of 13 (10 x 13), corrugated in parallel
