

## H distributor - QPD H 3PE2.5 6-10 BK - 1582145

Please be informed that the data shown in this PDF Document is generated from our Online Catalog. Please find the complete data in the user's documentation. Our General Terms of Use for Downloads are valid (<http://phoenixcontact.com/download>)



H distributor, QUICKON connection, number of positions: 3+PE, 1 mm<sup>2</sup> ... 2.5 mm<sup>2</sup>, 690 V, 20 A, black, with four QUICKON nuts, cable diameter range: 6 mm ... 10 mm, with a sealing bolt

### Your advantages

- ✓ Innovative and time saving - QUICKON fast connection for time saving of up to 80 % for on-site connection
- ✓ Convenient: quick and easy assembly without special tools
- ✓ Robust throughout: housing with IP68/IP69K and IK07 protection for a wide range of applications
- ✓ Safer connection thanks to polarization against mismatching and touch-proof protection according to DIN EN 0105
- ✓ Flexible and compact - by connecting connections internally, H and T-distributors can be used to branch master cables or they can be used as star distributors

### Key Commercial Data

Packing unit	1 pc
GTIN	
GTIN	4046356316804
Weight per Piece (excluding packing)	150.100 g
Custom tariff number	85366990
Country of origin	Germany

### Technical data

#### General

Type	H-distributor
Color	black
Locking type	Screw locking
Connection method	QUICKON connection
	IDC connection
Number of positions	4
Note number of positions	3+PE
Wrench size, union nut	22 mm

# H distributor - QPD H 3PE2.5 6-10 BK - 1582145

## Technical data

### General

Tightening torque, union nut	5 Nm
Number of connections	4
Conductor cross section flexible min.	1 mm <sup>2</sup>
Conductor cross section flexible max.	2.5 mm <sup>2</sup>
Conductor cross section solid min.	1 mm <sup>2</sup>
Conductor cross section solid max.	2.5 mm <sup>2</sup>
Conductor cross section AWG min.	16
Conductor cross section AWG max.	14

### Cabel

Structure of individual litz in acc. with VDE 0295 / smallest wire diameter	VDE 0295 class 1 to 6/min. 0.15 mm
Wire insulation material	PVC/PE/TPE/rubber
Wire diameter including insulation	2 mm ... 3.8 mm
External cable diameter	6 mm ... 10 mm
Position marking	1, 2, 3, PE

### Ambient conditions

Degree of protection	IP66
	IP68 (2 m / 24 h)
	IP69K
Ambient temperature (operation)	-40 °C ... 100 °C
Ambient temperature (storage/transport)	-40 °C ... 100 °C
Temperature when conductor connected	-5 °C ... 50 °C

### Electrical characteristics

Nominal current I <sub>N</sub>	20 A
Rated current	20 A
Rated voltage (III/3)	690 V
Rated voltage (III/2)	1000 V
Rated voltage (II/2)	1000 V
Rated surge voltage (III/3)	6 kV
Rated surge voltage (III/2)	8 kV
Rated surge voltage (II/2)	8 kV

### Mechanical characteristics

QUICKON connectability	max. 10
Insertion/withdrawal cycles	50 (QUICKON connections max. 10)
Category of shock impact	IK07

### Material data

Contact material	Cu
Contact surface material	silver-plated
Contact carrier material	PA

# H distributor - QPD H 3PE2.5 6-10 BK - 1582145

## Technical data

### Material data

Insulating material	PA
Flammability rating according to UL 94	V0
Overvoltage category	III
Degree of pollution	3

### Standards and Regulations

Flammability rating according to UL 94	V0
--	----

### Environmental Product Compliance

China RoHS	Environmentally friendly use period: unlimited = EFUP-e
	No hazardous substances above threshold values

## Drawings

Circuit diagram

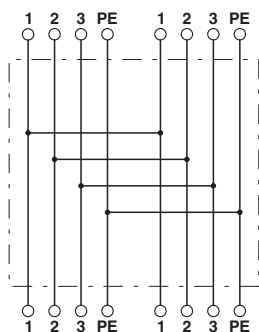

Diagram

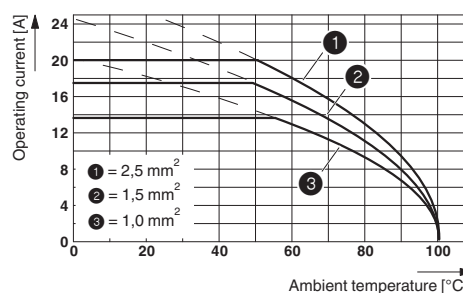

Dimensional drawing

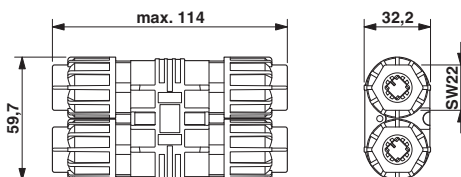

Dimensional drawing

# H distributor - QPD H 3PE2.5 6-10 BK - 1582145

Schematic diagram

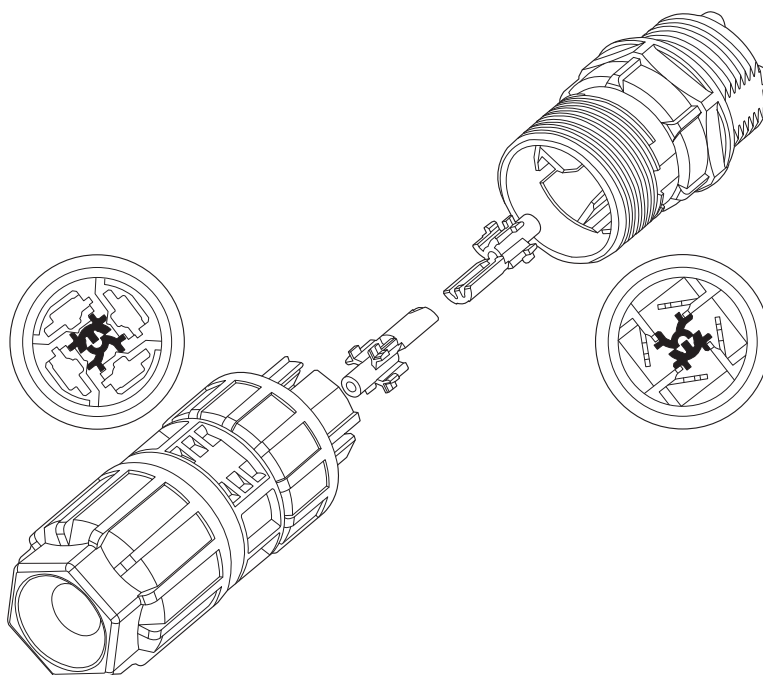

Coding of the QUICKON plug-in connection

## Classifications

eCl@ss

eCl@ss 4.0	272607xx
eCl@ss 4.1	27260701
eCl@ss 5.0	27143424
eCl@ss 5.1	27143400
eCl@ss 6.0	27143400
eCl@ss 7.0	27440603
eCl@ss 8.0	27440603
eCl@ss 9.0	27440603

ETIM

ETIM 3.0	EC001121
ETIM 4.0	EC002635
ETIM 5.0	EC002567
ETIM 6.0	EC002925

UNSPSC

UNSPSC 6.01	30211923
UNSPSC 7.0901	39121522
UNSPSC 11	39121522
UNSPSC 12.01	39121522

# H distributor - QPD H 3PE2.5 6-10 BK - 1582145

## Classifications

### UNSPSC

UNSPSC 13.2	31251501
-------------	----------

## Approvals

### Approvals

#### Approvals

UL Listed / cUL Listed / GL / UL Listed / IECCEB Scheme / cUL Listed / VDE Zeichengenehmigung / EAC

#### Ex Approvals

## Approval details

UL Listed		<a href="http://database.ul.com/cgi-bin/XYV/template/LISEXT/1FRAME/index.htm">http://database.ul.com/cgi-bin/XYV/template/LISEXT/1FRAME/index.htm</a>	FILE E 468743
Nominal voltage UN		600 V	
Nominal current IN		10 A	
mm <sup>2</sup> /AWG/kcmil		16	

cUL Listed		<a href="http://database.ul.com/cgi-bin/XYV/template/LISEXT/1FRAME/index.htm">http://database.ul.com/cgi-bin/XYV/template/LISEXT/1FRAME/index.htm</a>	FILE E 468743
Nominal voltage UN		600 V	
Nominal current IN		10 A	
mm <sup>2</sup> /AWG/kcmil		16	

GL		<a href="http://exchange.dnv.com/tari/">http://exchange.dnv.com/tari/</a>	6195914 HH
----	---	---	------------

UL Listed		<a href="http://database.ul.com/cgi-bin/XYV/template/LISEXT/1FRAME/index.htm">http://database.ul.com/cgi-bin/XYV/template/LISEXT/1FRAME/index.htm</a>	FILE E 221474
Nominal voltage UN		600 V	
Nominal current IN		15 A	
mm <sup>2</sup> /AWG/kcmil		14	

# H distributor - QPD H 3PE2.5 6-10 BK - 1582145

## Approvals

IECEE CB Scheme		<a href="http://www.iecee.org/">http://www.iecee.org/</a>	DE1-58228
-----------------	--	---	-----------

cUL Listed		<a href="http://database.ul.com/cgi-bin/XYV/template/LISEXT/1FRAME/index.htm">http://database.ul.com/cgi-bin/XYV/template/LISEXT/1FRAME/index.htm</a>	FILE E 221474
Nominal voltage UN	600 V		
Nominal current IN	15 A		
mm <sup>2</sup> /AWG/kcmil	14		

VDE Zeichengenehmigung		<a href="http://www2.vde.com/de/Institut/Online-Service/VDE-gepruefteProdukte/Seiten/Online-Suche.aspx">http://www2.vde.com/de/Institut/Online-Service/VDE-gepruefteProdukte/Seiten/Online-Suche.aspx</a>	40029149
Nominal voltage UN	690 V		
Nominal current IN	20 A		
mm <sup>2</sup> /AWG/kcmil	1.5-2.5		

EAC		RU C-DE.AI30.B.01102
-----	--	----------------------

## Accessories

Accessories

Coding element

Coding profile - CP-QPD - 1582459



Coding profile red, for pushing into the QUICKON dome and connector, can be positioned in 90° steps.

## Device marking

## H distributor - QPD H 3PE2.5 6-10 BK - 1582145

### Accessories

Engraving material - GPE 13X 9 WH - 0806932



Engraving material, Sheet, white, unlabeled, can be labeled with: PLOTMARK, ENGRAVING UNIT, CMS-P1-PLOTTER, P1 ENGRAVING UNIT, mounting type: adhesive, lettering field size: 13 x 9 mm

---

### Mounting material

Assembly clip - QPD CLIP 2,5 BK - 1582235



Holding clip for Quickon-H distributor, for snapping on and removal without tools.

---

### Protective cap

Protective cap - QPD QSK 2,5 FS - 1582488



Plastic protective cap, for QPD-QUICKON connectors, green, with holding band, IP68

---

### Sealing plugs

Closing cap - SEALING PLUG 10X16 RD - 1400284



Closing cap, PA, for threads pluggable, color: red

---

### Socket spanner

Socket wrench - QSS 22 - 1670206



Allen wrench, for loosening and fastening the QUICKON union nut, WAF 22 mm

## H distributor - QPD H 3PE2.5 6-10 BK - 1582145

### Accessories

Connector - QPD P 3PE2,5 6-10 BK - 1582202



Connector, QUICKON connection, number of positions: 3+PE, 1 mm<sup>2</sup> ... 2.5 mm<sup>2</sup>, 690 V, 20 A, black, cable diameter range: 6 mm ... 10 mm

---

Connector - QPD P 3PE2,5 9-14 BK - 1582205



Connector, QUICKON connection, number of positions: 3+PE, 1 mm<sup>2</sup> ... 2.5 mm<sup>2</sup>, 690 V, 20 A, black, cable diameter range: 9 mm ... 14 mm

---