

Panel feed-through - QPD W 3PE2.5 6-10 M25 DT BK - 1582169

Please be informed that the data shown in this PDF Document is generated from our Online Catalog. Please find the complete data in the user's documentation. Our General Terms of Use for Downloads are valid (<http://phoenixcontact.com/download>)



Panel feed-through, QUICKON connection, number of positions: 3+PE, 1 mm² ... 2.5 mm², 690 V, 20 A, black, with QUICKON nut, cable diameter range: 6 mm ... 10 mm, assembly thread: M25, Push-in connection, 2.5 mm²

Your advantages

- ✔ Innovative and time saving - QUICKON fast connection for time saving of up to 80 % for on-site connection
- ✔ Convenient: quick and easy assembly without special tools
- ✔ Robust throughout: housing with IP68/IP69K and IK07 protection for a wide range of applications
- ✔ Safer connection thanks to polarization against mismatching and touch-proof protection according to DIN EN 0105
- ✔ Efficient - by using panel feed-throughs, devices no longer need to be opened in order to connect cables

Key Commercial Data

Packing unit	1 pc
GTIN	 4 046356 449076
GTIN	4046356449076
Weight per Piece (excluding packing)	40.600 g
Custom tariff number	85366990
Country of origin	Germany

Technical data

General

Connection	For 2.5 mm ² cables with ferrule, only CRIMPFOX 10S pliers (1212045) with square crimp can be used. CRIMPFOX 6H hexagonal crimping pliers (1212046) cannot be used, because the diameter on the diagonal is too large.
Type	QPD 4x2,5
Color	black
Locking type	Screw locking
Connection method	QUICKON connection
	IDC connection

Panel feed-through - QPD W 3PE2.5 6-10 M25 DT BK - 1582169

Technical data

General

Number of positions	4
Note number of positions	3+PE
Wrench size, union nut	22 mm
Tightening torque, union nut	5 Nm
Tightening torque, counter nut	5 Nm
Wrench size, counter nut	27 mm
Number of connections	10
Conductor cross section flexible min.	1 mm ²
Conductor cross section flexible max.	2.5 mm ²
Conductor cross section solid min.	1 mm ²
Conductor cross section solid max.	2.5 mm ²
Conductor cross section AWG min.	16
Conductor cross section AWG max.	14

Cabel

Structure of individual litz in acc. with VDE 0295 / smallest wire diameter	VDE 0295 class 1 to 6/min. 0.15 mm
Wire insulation material	PVC/PE/Rubber/TPE
Wire diameter including insulation	2 mm ... 3.8 mm
External cable diameter	6 mm ... 10 mm
Conductor cross section	2.5 mm ²
Position marking	1, 2, 3, PE

Ambient conditions

Degree of protection	IP66
	IP68 (2 m / 24 h)
	IP69K
Ambient temperature (operation)	-40 °C ... 100 °C
Ambient temperature (storage/transport)	-40 °C ... 100 °C
Temperature when conductor connected	-5 °C ... 50 °C

Electrical characteristics

Nominal current I _N	20 A
Rated current	20 A
Rated voltage (III/3)	690 V
Rated voltage (III/2)	1000 V
Rated voltage (II/2)	1000 V
Rated surge voltage (III/3)	6 kV
Rated surge voltage (III/2)	8 kV
Rated surge voltage (II/2)	8 kV

Mechanical characteristics

QUICKON connectability	max. 10
Insertion/withdrawal cycles	>=

Panel feed-through - QPD W 3PE2.5 6-10 M25 DT BK - 1582169

Technical data

Mechanical characteristics

Category of shock impact	IK07
--------------------------	------

Material data

Contact material	Cu
Contact surface material	silver-plated
Contact carrier material	PA
Insulating material	PA
Flammability rating according to UL 94	V0
Overvoltage category	III
Degree of pollution	3

Standards and Regulations

Flammability rating according to UL 94	V0
--	----

Environmental Product Compliance

China RoHS	Environmentally Friendly Use Period = 50
	For details about hazardous substances go to tab "Downloads", Category "Manufacturer's declaration"

Drawings

Diagram

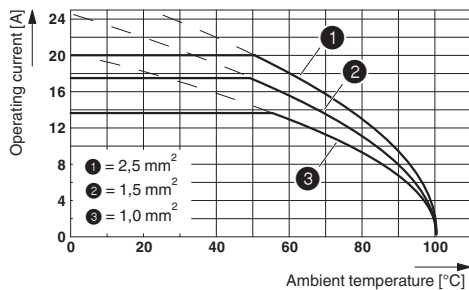

Dimensional drawing

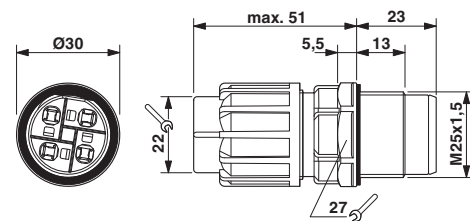

Dimensional drawing: QPD W...

Derating diagram

Dimensional drawing

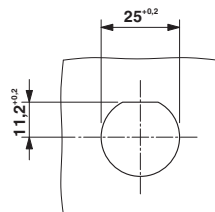

Panel cutout

Panel feed-through - QPD W 3PE2.5 6-10 M25 DT BK - 1582169

Schematic diagram

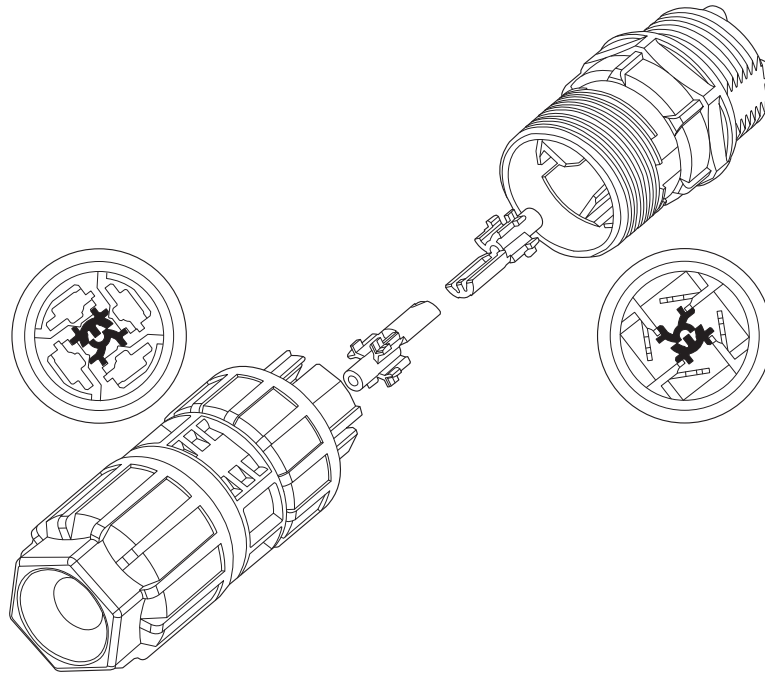

Encoding of the QUICKON connector

Classifications

eCl@ss

eCl@ss 4.0	27140815
eCl@ss 4.1	27140815
eCl@ss 5.0	27143423
eCl@ss 5.1	27143400
eCl@ss 6.0	27143400
eCl@ss 7.0	27440602
eCl@ss 8.0	27440602
eCl@ss 9.0	27440602

ETIM

ETIM 2.0	EC000516
ETIM 3.0	EC000516
ETIM 4.0	EC002635
ETIM 5.0	EC002566
ETIM 6.0	EC002061

UNSPSC

UNSPSC 6.01	31251501
UNSPSC 7.0901	31251501
UNSPSC 11	31251501

Panel feed-through - QPD W 3PE2.5 6-10 M25 DT BK - 1582169

Classifications

UNSPSC

UNSPSC 12.01	39121522
UNSPSC 13.2	39121522

Approvals

Approvals

Approvals

GL / IECCEB Scheme / VDE Zeichengenehmigung / EAC

Ex Approvals

Approval details

GL		http://exchange.dnv.com/tari/	6195914 HH
----	---	---	------------

IECEE CB Scheme		http://www.iecee.org/	DE1-58228
-----------------	---	---	-----------

VDE Zeichengenehmigung		http://www2.vde.com/de/Institut/Online-Service/VDE-gepruefteProdukte/Seiten/Online-Suche.aspx	40029149
------------------------	---	---	----------

Nominal voltage UN	690 V
Nominal current IN	20 A
mm ² /AWG/kcmil	1.5-2.5

EAC		RU C- DE.AI30.B.01102
-----	---	--------------------------

Accessories

Accessories

Coding element

Panel feed-through - QPD W 3PE2.5 6-10 M25 DT BK - 1582169

Accessories

Coding profile - CP-QPD - 1582459



Coding profile red, for pushing into the QUICKON dome and connector, can be positioned in 90° steps.

Device marking

Plastic label - EMLP (13X9)R - 0819453



Plastic label, Roll, white, unlabeled, can be labeled with: THERMOMARK ROLLMASTER 300/600, THERMOMARK X1.2, THERMOMARK ROLL X1, THERMOMARK ROLL 2.0, THERMOMARK ROLL, mounting type: adhesive, lettering field size: 13 x 9 mm

Engraving material - GPE 13X 9 WH - 0806932



Engraving material, Sheet, white, unlabeled, can be labeled with: PLOTMARK, ENGRAVING UNIT, CMS-P1-PLOTTER, P1 ENGRAVING UNIT, mounting type: adhesive, lettering field size: 13 x 9 mm

Mounting material

Nut - Q-MU M25 - 1640715



Nut (plastic) to lock the contact carrier from the inside of the device

Protective cap

Protective cap - QPD QSK 2,5 FS - 1582488



Plastic protective cap, for QPD-QUICKON connectors, green, with holding band, IP68

Panel feed-through - QPD W 3PE2.5 6-10 M25 DT BK - 1582169

Accessories

Protective cap - QPD QSK 2,5 - 1582150



Protective cap made of transparent plastic for QPD QUICKON connection 4x 2.5 mm², IP50.

Seal

Seal - KV-DI-PG16-1XASI - 1582462



Seal for one AS-i line, 17.2 x 9 mm, from NBR, black, for IP65/67 degree of protection

Seal - KV-DI-PG16-2XASI - 1582464



Seal for two AS-i lines, 17.2 x 9 mm, from NBR, black, for IP65/67 degree of protection

Sealing plugs

Closing cap - SEALING PLUG 10X16 RD - 1400284



Closing cap, PA, for threads pluggable, color: red

Socket spanner

Socket wrench - QSS 22 - 1670206



Allen wrench, for loosening and fastening the QUICKON union nut, WAF 22 mm
