

Double valve connector cable - SAC- 3,0/0,15-116/2XA-1L-Z - 1458033

Please be informed that the data shown in this PDF Document is generated from our Online Catalog. Please find the complete data in the user's documentation. Our General Terms of Use for Downloads are valid (<http://phoenixcontact.com/download>)



Double valve connector cable, 4-position, PUR/PVC, black RAL 9005, free cable end, on Valve connector A, with 1 LED, connected with Z diode and Valve connector A, with 1 LED, connected with Z diode, cable length: 3 m, valve connector spacing: 0.15 m

Why buy this product

- ✓ Easy and safe: 100% electrically tested plug-in components
- ✓ Robust valve connector with Zener diode as protective circuit
- ✓ Efficient: control valves with two connections via a single connecting cable
- ✓ Convenient: increased machine availability thanks to quick and easy diagnostics

RoHS

Key Commercial Data

| | |
|--------------------------------------|---|
| Packing unit | 1 STK |
| GTIN |  4 046356 638456 |
| GTIN | 4046356638456 |
| Weight per Piece (excluding packing) | 260.000 g |
| Custom tariff number | 85444290 |
| Country of origin | Poland |

Technical data

Dimensions

| | |
|-------------------------------|---------|
| Length of cable | 3 m |
| Valve connector distance | 0.15 m |
| Central screw valve connector | M3 x 29 |

Ambient conditions

| | |
|---------------------------------|-------------------------------|
| Ambient temperature (operation) | -25 °C ... 85 °C (valve plug) |
|---------------------------------|-------------------------------|

Double valve connector cable - SAC- 3,0/0,15-116/2XA-1L-Z - 1458033

Technical data

Ambient conditions

| | |
|----------------------|------|
| Degree of protection | IP65 |
| | IP67 |

General

| | |
|------------------------------|-------------------------------|
| Rated current at 40°C | 4 A |
| Rated voltage | 24 V AC |
| | 24 V DC |
| Number of positions | 4 |
| Insulation resistance | ≥ 100 MΩ |
| Standards/regulations | Valve connector EN 175301-803 |
| Status display | 1 LED |
| Protective circuit/component | Z diode |
| | 70 V () |
| Reverse voltage | 50 V |
| Overvoltage category | II |
| Degree of pollution | 3 |
| Insertion/withdrawal cycles | 50 |
| Torque | 0.6 Nm (Valve connector) |

Material

| | |
|--|-------------------|
| Flammability rating according to UL 94 | HB |
| Valve plug contact material | CuSn |
| Valve plug contact surface material | Sn |
| Valve plug contact insert material | PA 6.6 |
| Material housing valve plug | TPU |
| Sealing material | TPU (Seal molded) |

Standards and Regulations

| | |
|--|-----------------|
| Standard designation | Valve connector |
| Standards/regulations | EN 175301-803 |
| Flammability rating according to UL 94 | HB |

Cable

| | |
|---------------------------|--------------------------|
| Cable type | PUR/PVC, 0.75 mm², black |
| Cable type (abbreviation) | 116 |
| Cable abbreviation | LiYY11Y-HF |
| UL AWM style | 20549 |
| Conductor cross section | 4x 0.75 mm² |
| AWG signal line | 18 |

Double valve connector cable - SAC- 3,0/0,15-116/2XA-1L-Z - 1458033

Technical data

Cable

| | |
|---|--|
| Conductor structure signal line | 24x 0.20 mm |
| Core diameter including insulation | 1.7 mm ±0.05 mm |
| Wire colors | Black 1, black 2, black 3, green/yellow |
| Overall twist | 4 wires, twisted |
| External sheath, color | black |
| External cable diameter D | 6.3 mm ±0.2 mm |
| Smallest bending radius, fixed installation | 63 mm |
| Outer sheath, material | PUR |
| Material, inner sheath | PVC |
| Material conductor insulation | PVC |
| Conductor material | Bare Cu litz wires |
| Insulation resistance | ≥ 20 MΩ*km |
| Conductor resistance | 26 Ω/km (at 20 °C) |
| Nominal voltage, cable | 300 V |
| Test voltage, cable | 1200 V |
| Flame resistance | According to DIN VDE 0482 |
| | According to DIN EN 50265-2-1 |
| | in acc. with UL FT-2 |
| Ambient temperature (operation) | -40 °C ... 80 °C (cable, fixed installation) |
| | -5 °C ... 80 °C (cable, flexible installation) |

Environmental Product Compliance

| | |
|------------|---|
| REACH SVHC | Lead 7439-92-1 |
| China RoHS | Environmentally Friendly Use Period = 50 |
| | For details about hazardous substances go to tab "Downloads", Category "Manufacturer's declaration" |

Drawings

Schematic diagram

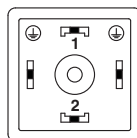

Valve connector pin assignment, type A

Cable cross section

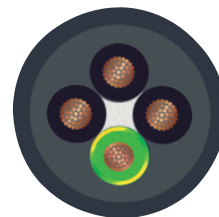

PUR/PVC black [116]

Double valve connector cable - SAC- 3,0/0,15-116/2XA-1L-Z - 1458033

Dimensional drawing

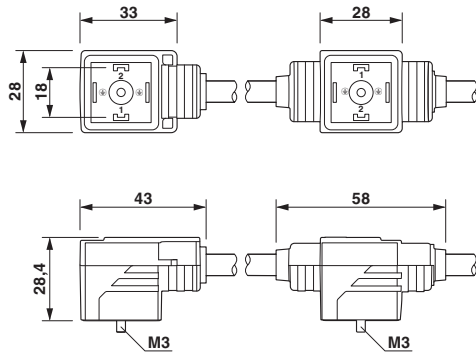

Dimensional drawing

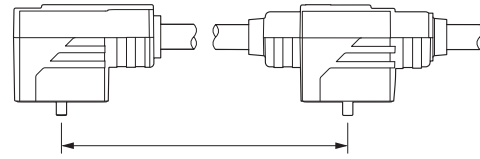

Valve connector spacing

Double valve connector, 2x type A

Circuit diagram

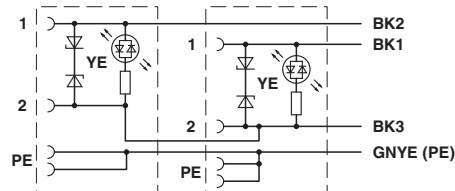

Contact assignment of the double-valve connector

Classifications

eCl@ss

| | |
|------------|----------|
| eCl@ss 4.0 | 27060306 |
| eCl@ss 4.1 | 27060306 |
| eCl@ss 5.0 | 27061801 |
| eCl@ss 5.1 | 27061800 |
| eCl@ss 6.0 | 27279200 |
| eCl@ss 7.0 | 27279218 |
| eCl@ss 8.0 | 27279218 |
| eCl@ss 9.0 | 27060312 |

ETIM

| | |
|----------|----------|
| ETIM 4.0 | EC001855 |
|----------|----------|

Double valve connector cable - SAC- 3,0/0,15-116/2XA-1L-Z - 1458033

Classifications

ETIM

| | |
|----------|----------|
| ETIM 5.0 | EC001855 |
| ETIM 6.0 | EC001855 |

UNSPSC

| | |
|---------------|----------|
| UNSPSC 6.01 | 31251501 |
| UNSPSC 7.0901 | 31251501 |
| UNSPSC 11 | 31251501 |
| UNSPSC 12.01 | 31251501 |
| UNSPSC 13.2 | 31251501 |

Approvals

Approvals

Approvals

CSA / CSAus / cCSAus

Ex Approvals

Approval details

| | | | |
|--------------------|---|---|-------|
| CSA |  | http://www.csagroup.org/services-industries/product-listing/ | 13631 |
| Nominal voltage UN | | 24 V | |
| Nominal current IN | | 4 A | |

| | | | |
|--------------------|---|---|-------|
| CSAus |  | http://www.csagroup.org/services-industries/product-listing/ | 13631 |
| Nominal voltage UN | | 24 V | |
| Nominal current IN | | 4 A | |

Double valve connector cable - SAC- 3,0/0,15-116/2XA-1L-Z - 1458033

Approvals

cCSAus



<http://www.csagroup.org/us/en/services/testing-and-certification/certified-product-listing>

Accessories

Accessories

Conductor marking

Insert label - PABA WH/23 - 1013779



Insert label, Strip, white, unlabeled, can be labeled with: CMS-P1-PLOTTER, mounting type: thread on, cable diameter range: 1.5 - 35 mm, lettering field size: 23 x 4 mm

Insert label - PABA YE/23 - 1013782



Insert label, Strip, yellow, unlabeled, can be labeled with: CMS-P1-PLOTTER, mounting type: thread on, cable diameter range: 1.5 - 35 mm, lettering field size: 23 x 4 mm

Insert label - PABA WH/15 - 1013151



Insert label, Strip, white, unlabeled, can be labeled with: CMS-P1-PLOTTER, mounting type: thread on, cable diameter range: 0.6 - 50 mm, lettering field size: 15 x 4 mm

Insert label - PABA YE/15 - 1013698



Insert label, Strip, yellow, unlabeled, can be labeled with: CMS-P1-PLOTTER, mounting type: thread on, cable diameter range: 0.6 - 50 mm, lettering field size: 15 x 4 mm

Double valve connector cable - SAC- 3,0/0,15-116/2XA-1L-Z - 1458033

Accessories

Insert label - PABA RD/15 - 1013944



Insert label, Strip, red, unlabeled, can be labeled with: CMS-P1-PLOTTER, mounting type: thread on, cable diameter range: 0.6 - 50 mm, lettering field size: 15 x 4 mm

Corrugated pipe

Protective hose - WP-PA HF 13,0 BK - 3240681



Polyamide protective hose, inflammability class V0, UV resistant

Protective hose - WP-PA HF-HB 13,0 BK - 3240839



Polyamide protective hose, inflammability class HB, UV resistant

Cutting tools

Diagonal cutter - CUTFOX-S VDE - 1212207



Diagonal cutter for hard (piano wire) and soft wires, VDE 1000 V AC/1500 V DC tested

Marker carrier cable

Double valve connector cable - SAC- 3,0/0,15-116/2XA-1L-Z - 1458033

Accessories

Conductor marker carrier - PATG 2/15 - 1013038



Conductor marker carrier, transparent, unlabeled, mounting type: slide on, cable diameter range: 2 - 4 mm, lettering field size: 15 x 4 mm

Conductor marker carrier - PATG 3/15 - 1013041



Conductor marker carrier, transparent, unlabeled, mounting type: slide on, cable diameter range: 4 - 7 mm, lettering field size: 15 x 4 mm

Conductor marker carrier - PATG 4/15 - 1013054



Conductor marker carrier, transparent, unlabeled, mounting type: slide on, cable diameter range: 6 - 10 mm, lettering field size: 15 x 4 mm

Marker pen

Marker pen - B-STIFT - 1051993



Marker pen, for manual labeling of unprinted Zack strips, smear-proof and waterproof, line thickness 0.5 mm

Screwdriver tools

Screw insert - SF-BIT-PH 1-70 - 1212582



Screw bit, PH crosshead, E6.3-1/4" drive, size: PH 1 x 70 mm, hardened, suitable for holder according to DIN 3126-F6.3/ISO 1173

Double valve connector cable - SAC- 3,0/0,15-116/2XA-1L-Z - 1458033

Accessories

Stripping tool

Stripping tool - WIREFOX SAC-1 - 1212757



Stripping pliers, for halogen-free sensor/actuator cables (SAC cables), with PUR and PVC insulation, from Ø of 3.2 to 4.4 mm, any stripping length

Stripping tool - WIREFOX SAC - 1212623



Stripping pliers, for halogen-free sensor/actuator cables (SAC cables), with PUR and PVC insulation, from Ø of 4.4 to 7 mm, any stripping length

Stripping tool - WIREFOX 10 - 1212150



Stripping tool, for cables and conductors from 0.02 - 10 mm², self-adjusting, stripping length of up to 18 mm, cutting capacity of up to 10 mm² stranded/1.5 mm² solid, replaceable stripping blade

Torque tool

Torque screwdriver - TSD-M 1,2NM - 1212224



Torque screw driver, accuracy as per EN ISO 6789 standard, adjustable from 0.3 - 1.2 Nm

Double valve connector cable - SAC- 3,0/0,15-116/2XA-1L-Z - 1458033

Accessories

Protective hose adapter - WP-CTA POM 13,0 BK - 1422884



Protective hose adapter, for corrugated hoses with a nominal size of 13 (10 x 13), corrugated in parallel