

## Sensor/actuator box - SACB-4/ 8-L-C SCO - 1516797

Please be informed that the data shown in this PDF Document is generated from our Online Catalog. Please find the complete data in the user's documentation. Our General Terms of Use for Downloads are valid (<http://phoenixcontact.com/download>)



Sensor/actuator box, Application: Standard, Connection method: M12-SPEEDCON-socket Metal, Number of slots: 4, Number of positions: 5, Slot assignment: Double, Status indication: Yes, pnp; Master cable connection: Pluggable screw connection 180°, Shielding: No

### Product Features

- ✓ Safety in the field, thanks to molded housing and high degree of protection
- ✓ Flexible, distributed bundling of signals in one master cable
- ✓ Convenient: increased machine availability thanks to quick and easy diagnostics
- ✓ Save space: distributor box with double occupancy for two sensors in one slot
- ✓ Save time, thanks to installation with SPEEDCON fast locking system
- ✓ Flexible: distributor box with connector hood for on-site assembly



### Key commercial data

Packing unit	1 pc
Weight per Piece (excluding packing)	253.2 GRM
Custom tariff number	85366990
Country of origin	Poland

### Technical data

#### General

Rated voltage	24 V DC
Max. operating voltage $U_{max}$	30 V DC
Current carrying capacity per I/O signal	2 A
Current carrying capacity per slot	4 A
Total rated current	10 A
	2x 8 A (For electrical isolation)
Number of positions	5
Number of slots	4

## Sensor/actuator box - SACB-4/ 8-L-C SCO - 1516797

### Technical data

#### General

Inflammability class according to UL 94	V0
Sensor/actuator connection system	M12-SPEEDCON-socket

#### Ambient conditions

Degree of protection	IP65
	IP67
	IP69K
Ambient temperature (operation)	-30 °C ... 80 °C

#### Local diagnostics function

Local diagnostics	Supply voltage per module Green LED
	Status display I/O Yellow LED

#### Master cable data/connection data

Connection method	Pluggable screw connection
Conductor cross section min. (signal)	0.14 mm <sup>2</sup>
Conductor cross section max. (signal)	1.5 mm <sup>2</sup>
Conductor cross section AWG min. (signal)	26
Conductor cross section AWG max. (signal)	16
Stripping length (signal)	7 mm
Conductor cross section min. (energy)	0.14 mm <sup>2</sup>
Conductor cross section max. (energy)	1.5 mm <sup>2</sup>
Conductor cross section AWG min. (energy)	26
Conductor cross section AWG max. (energy)	16
External cable diameter min.	7 mm
External cable diameter max.	12 mm
Stripping length	50 mm (Master cable)
Tightening torque, cover screw	0.35 Nm
Tightening torque, union nut	2.5 Nm
Tightening torque slot sensor/actuator cable	0.4 Nm
Tightening torque of mounting screw for fixing the housing	0.5 Nm

#### Insulation material

Housing material	PBT
Material of the moulding mass	PUR
Contact material	Cu alloy
Contact surface material	Gold-plated
Contact carrier material	PA
Material of contact, master cable side	CU alloy

## Sensor/actuator box - SACB-4/ 8-L-C SCO - 1516797

### Technical data

#### Insulation material

Material of contact surface, master cable side	Gold-plated
Material of the contact carrier on the master cable side	PA 66 V0
Material of threaded sleeve	Zinc die-cast
Material of threaded sleeve surface	Nickel-plated
Material, O-ring	NBR

#### Pin assignment

Slot/position = Wire color or connection	1 / 4 (A) = 1 / 4
	1 / 2 (B) = 1 / 2
	2 / 4 (A) = 2 / 4
	2 / 2 (B) = 2 / 2
	3 / 4 (A) = 3 / 4
	3 / 2 (B) = 3 / 2
	4 / 4 (A) = 4 / 4
	4 / 2 (B) = 4 / 2
	1-4 / 1 (+ 24 V) = U <sub>N</sub>
	1-4 / 3 (0 V) = 0 V
	1-4 / 5 (PE) = PE

### Classifications

#### eCl@ss

eCl@ss 4.0	27140815
eCl@ss 4.1	27140815
eCl@ss 5.0	27143423
eCl@ss 5.1	27143423
eCl@ss 6.0	27143423
eCl@ss 7.0	27449001
eCl@ss 8.0	27449001

#### ETIM

ETIM 2.0	EC000200
ETIM 3.0	EC001856
ETIM 4.0	EC002585
ETIM 5.0	EC002585

#### UNSPSC

UNSPSC 6.01	31261501
-------------	----------

# Sensor/actuator box - SACB-4/ 8-L-C SCO - 1516797

## Classifications

### UNSPSC

UNSPSC 7.0901	31261501
UNSPSC 11	31261501
UNSPSC 12.01	31261501
UNSPSC 13.2	31261501

## Approvals

### Approvals

Approvals

UL Recognized / cUL Recognized / GOST / cULus Recognized

Ex Approvals

Approvals submitted

### Approval details

UL Recognized 	
Nominal current IN	3 A
Nominal voltage UN	24 V

cUL Recognized 	
Nominal current IN	3 A
Nominal voltage UN	24 V

GOST 	
--	--

## Sensor/actuator box - SACB-4/ 8-L-C SCO - 1516797

### Approvals

cULus Recognized 

### Accessories

#### Accessories

#### Cable by the meter

Master cable ring - SACB- 8X0,5/ 3X1,0-50,0 PUR - 1503357



Master cable for sensor/actuator boxes, with PE conductor, unshielded, material PUR/PVC, 11-pos., 8 x 0.50 mm<sup>2</sup> and 3 x 1.00 mm<sup>2</sup>, length: 50 m

#### Connector hood without master cable

Connector hood - SACB-C-H180 8/16 SCO - 1516713



Connector hood with an integrated connector, for M12 sensor/actuator boxes with metal thread and pluggable screw connection, for 4, 6 or 8 slots

#### Device marking

Contact marker – zack marker strip - SS-ZB 17,5 WH - 0804963



Contact marker – zack marker strip, Strip, white, unlabeled, can be labeled with: Plotter, Mounting type: Snap into flat marker groove, Lettering field: 17.5 x 9 mm

Contact marker – zack marker strip - SS-ZB 17,5 YE - 0804976



Contact marker – zack marker strip, Strip, yellow, unlabeled, can be labeled with: Plotter, Mounting type: Snap into flat marker groove, Lettering field: 17.5 x 9 mm

## Sensor/actuator box - SACB-4/ 8-L-C SCO - 1516797

### Accessories

---

#### Labeled device marker

Contactor marker – zack marker strip - SS-ZB 17,5 WH CUS - 0824468



Contactor marker – zack marker strip, can be ordered: Strip, white, labeled according to customer specifications, Mounting type: Snap into flat marker groove, Lettering field: 17.5 x 9 mm

---

Contactor marker – zack marker strip - SS-ZB 17,5 YE CUS - 0824469



Contactor marker – zack marker strip, can be ordered: Strip, yellow, labeled according to customer specifications, Mounting type: Snap into flat marker groove, Lettering field: 17.5 x 9 mm

---

#### Mounting rail adapter

Assembly adapters - UTA 107 - 2853983

Universal DIN rail adapter



#### Protective cap

Screw plug - PROT-MS SCO - 1553129



M12 screw plug with SPEEDCON quick locking for unoccupied M12 sockets of the sensor/actuator cables, boxes and flush-type connectors

---

#### Screwdriver tools

## Sensor/actuator box - SACB-4/ 8-L-C SCO - 1516797

### Accessories

Adapter insert - TSD-M SAC-BIT ADAPTER - 1212600



Adapter bit for TSD-M...torque tools, E6.3-1/4" drive with 4 mm hexagon to accommodate SAC bits

---

Tool - SAC BIT M12-D15 - 1208432



Nut for assembling sensor/actuator cables with M12 connector and for M12 connectors with QUICKON fast connection technology, for 4 mm hexagonal drive

---

Tool - SACC BIT M12-D20 - 1208445



Nut for assembling SACC M12 connectors for free assembly, excluding M12 connectors with QUICKON fast connection technology, for 4 mm hexagonal drive

---

Philips screwdriver - SZK PZ1 VDE - 1206450



Screwdriver, PZ crosshead, VDE insulated, size: PZ 1 x 80 mm, 2-component grip, with non-slip grip

---

Tool - SAC BIT HOOD-W 24 - 1212486



Nut for assembling pressure nuts with 24 mm wrench size, for 4 mm hexagonal drive

## Sensor/actuator box - SACB-4/ 8-L-C SCO - 1516797

### Accessories

Screw insert - SF-BIT-PZ 1-50 - 1212591



Screw bit, PZ crosshead, E6.3-1/4" drive, size: PZ 1 x 50 mm, hardened, suitable for holder according to DIN 3126-F6.3/ISO 1173

---

### Torque tool

Torque screwdriver - TSD 04 SAC - 1208429



Torque screwdriver, with preset torque of 0.4 Nm and 4 mm hexagonal drive for M12 connectors

---

Torque screwdriver - TSD-M 1,2NM - 1212224



Torque screw driver, accuracy as per EN ISO 6789 standard, adjustable from 0.3 - 1.2 Nm

---

Torque screwdriver - TSD 25 SAC - 1212315



Torque screwdriver, with preset torque of 2.5 Nm and 4 mm hexagonal drive for the pressure nut of the connector hood

---

Torque screwdriver - TSD-M 3NM - 1212225



Torque screw driver, accuracy as per EN ISO 6789 standard, adjustable from 1.2 - 3 Nm

---



# Sensor/actuator box - SACB-4/ 8-L-C SCO - 1516797

## Drawings

Schematic diagram

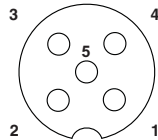

M12 slot, socket, 5-pos.

Schematic diagram

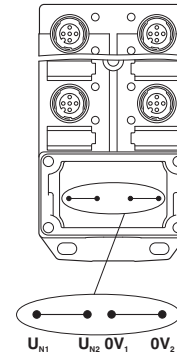

Potential  $U_{N1}$  and  $U_{N2}$  bridged. Potential assignment:  $U_{N1} = U_{N2} =$  slots 1,2,3,4.

Schematic diagram

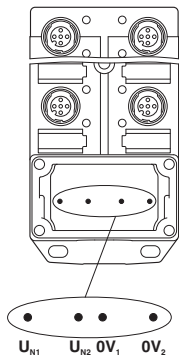

Electrically isolated. Potential assignment:  $U_{N1} =$  slots 1,3 and  $U_{N2} =$  slots 2,4.

Dimensioned drawing

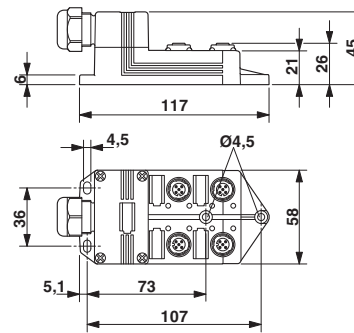

# Sensor/actuator box - SACB-4/ 8-L-C SCO - 1516797

Circuit diagram

