

Electronic device circuit breaker - CB E1 24DC/2A S-R P - 2800909

Please be informed that the data shown in this PDF Document is generated from our Online Catalog. Please find the complete data in the user's documentation. Our General Terms of Use for Downloads are valid (<http://phoenixcontact.com/download>)



Electronic device circuit breaker, 1-pos., active current limitation, status output and reset input, plug for base element.

The figure shows the CB E1 24DC/1A S-R P version

Product Features

- ✓ Compact design with precise nominal current levels
- ✓ Modular expansion possible thanks to the uniform, plug-in housing concept
- ✓ Sophisticated remote signaling concept enables monitoring from any location
- ✓ The reset input can be switched by means of remote control
- ✓ Active current limitation, even when switching capacitive loads
- ✓ Supply/remote signaling can be bridged with CLIPLINE complete accessories



Key commercial data

Packing unit	1 pc
Weight per Piece (excluding packing)	40.0 GRM
Custom tariff number	85362010
Country of origin	Germany

Technical data

General

Installation instructions	When mounted in rows without convection cooling, the nominal device current should only be led to a maximum of 80% due to the thermal effect during continuous operation (100% operating factor). Special precautionary measures must be taken in systems or machines, to prevent components from restarting (e.g., use of a safety PLC). Parallel connection of multiple circuit breakers is not permitted.
Inflammability class according to UL 94	V0
Mounting type	On base element
Color	gray

Electronic device circuit breaker - CB E1 24DC/2A S-R P - 2800909

Technical data

General

Number of positions	1
Pollution degree	2
Type	Male

Electrical data

Fuse type	Electronic
Rated surge voltage	0.5 kV
Operating voltage	24 V DC
	18 V DC ... 30 V DC
Nominal current I_N	2 A
Auxiliary contact type	Positive-switching signal output
Tripping method	E (electronic)
Required backup fuse	not required, integrated failsafe element
Dielectric strength	max. 30 V DC (Load circuit)
Voltage drop	100 mV (at I_N)
Switch off	typ. $1.25 \times I_N$
Current limitation	active
Contact type	Without electrical isolation
Closed circuit current I_0	typ. 8 mA (When switched on)
	typ. 11 mA (With status output)

Dimensions

Height	45 mm
Width	12.3 mm
Depth	52 mm
Complete module height	90 mm
Complete module width	12.3 mm
Complete module depth	77.3 mm

Ambient conditions

Ambient temperature (operation)	-25 °C ... 50 °C (non-condensing)
Ambient temperature (storage/transport)	-20 °C ... 70 °C
Degree of protection	IP30 (Actuation area)

Standards and Regulations

Standards/specifications	UL 2367
	UL 508
	CSA 22.2 No. 14
	EMV EN 61000-6-3 Noise emission

Electronic device circuit breaker - CB E1 24DC/2A S-R P - 2800909

Technical data

Standards and Regulations

	EMV EN 61000-6-2 Noise immunity
--	---------------------------------

Classifications

eCl@ss

eCl@ss 4.0	27141116
eCl@ss 4.1	27141116
eCl@ss 5.0	27141116
eCl@ss 5.1	27141116
eCl@ss 6.0	27141116
eCl@ss 7.0	27141116
eCl@ss 8.0	27141116

ETIM

ETIM 3.0	EC000899
ETIM 4.0	EC000899
ETIM 5.0	EC000899

UNSPSC

UNSPSC 6.01	30211812
UNSPSC 7.0901	39121411
UNSPSC 11	39121411
UNSPSC 12.01	39121411
UNSPSC 13.2	39121411

Approvals

Approvals

Approvals

UL Recognized / GL

Ex Approvals

Approvals submitted

Electronic device circuit breaker - CB E1 24DC/2A S-R P - 2800909

Approvals

Approval details

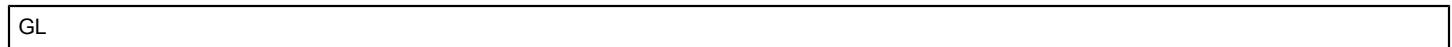

Accessories

Accessories

Bridge

Jumper - CB PT BRIDGE - 2801014



Bridge plug for bridging contacts 1 to 2 for CB base elements

Jumper - CB RC BRIDGE - 2801616



Bridge plug for bridging contacts 11 to 14 for CB base elements

Cutting tools

Front cutter - CUTFOX-FBS - 1212124



Cutting tool, for separating individual jumper bars from FBS ... plug-in bridges and EB ... insertion bridges

Jumper

Electronic device circuit breaker - CB E1 24DC/2A S-R P - 2800909

Accessories

Plug-in bridge - FBS 2-6 - 3030336



Plug-in bridge, Number of positions: 2, Color: red

Plug-in bridge - FBS 3-6 - 3030242



Plug-in bridge, Number of positions: 3, Color: red

Plug-in bridge - FBS 4-6 - 3030255



Plug-in bridge, Number of positions: 4, Color: red

Plug-in bridge - FBS 5-6 - 3030349



Plug-in bridge, Number of positions: 5, Color: red

Plug-in bridge - FBS 10-6 - 3030271



Plug-in bridge, Number of positions: 10, Color: red

Electronic device circuit breaker - CB E1 24DC/2A S-R P - 2800909

Accessories

Plug-in bridge - FBS 20-6 - 3030365



Plug-in bridge, Number of positions: 20, Color: red

Plug-in bridge - FBS 50-6 - 3032224



Plug-in bridge, Number of positions: 50, Color: red

Labeled terminal marker

Zack Marker strip, flat - ZBF 12 CUS - 0825018



Zack Marker strip, flat, can be ordered: Strip, white, labeled according to customer specifications, Mounting type: Snap into flat marker groove, for terminal block width: 12 mm, Lettering field: 5.15 x 12.15 mm

Terminal marking

Zack Marker strip, flat - ZBF 12:UNBEDRUCKT - 0809735



Zack Marker strip, flat, Strip, white, unlabeled, can be labeled with: Plotter, Mounting type: Snap into flat marker groove, for terminal block width: 12 mm, Lettering field: 5.15 x 12.15 mm

Drawings

Electronic device circuit breaker - CB E1 24DC/2A S-R P - 2800909

Dimensioned drawing

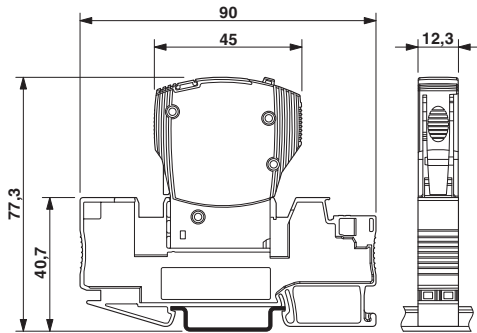

Diagram

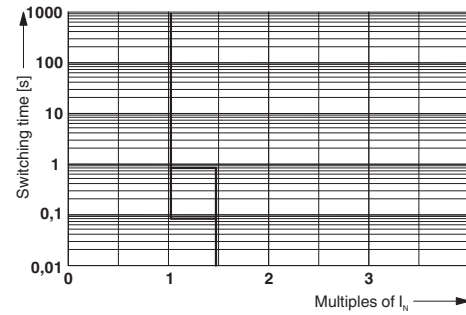

The figure shows the complete module consisting of a base element and connector

Trigger characteristic

Circuit diagram

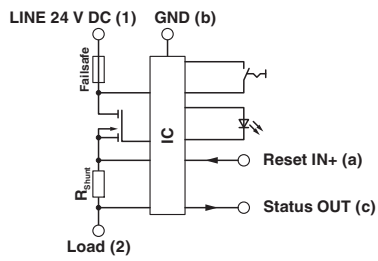

Catalog photo

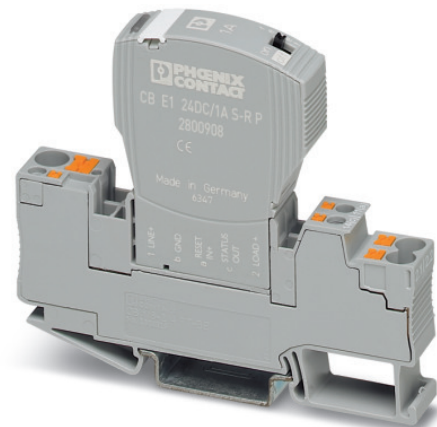

Figure may contain other products.

Electronic device circuit breaker - CB E1 24DC/2A S-R P - 2800909

Application drawing

