

Relay Module - PLC-RPT- 24UC/21-21 - 2900332

Please be informed that the data shown in this PDF Document is generated from our Online Catalog. Please find the complete data in the user's documentation. Our General Terms of Use for Downloads are valid (<http://phoenixcontact.com/download>)



PLC-INTERFACE, consisting of PLC-BPT.../21-21 basic terminal block with push-in connection and plug-in miniature relay with power contact, for mounting on NS 35/7,5 DIN rail, 2 PDTs, input voltage 24 V AC/DC

The figure shows a version with a screw connection

Product Features

- Slim design
- Efficient connection to system cabling using V8 adapter
- Safe isolation according to DIN EN 50178 between coil and contact
- RT III sealed relay
- Functional plug-in bridges
- Integrated input circuit and interference suppression circuit



Key commercial data

Packing unit	1 pc
Weight per Piece (excluding packing)	58.7 GRM
Custom tariff number	85364900
Country of origin	Germany

Technical data

Note

Utilization restriction	EMC: class A product, see manufacturer's declaration in the download area
-------------------------	---

Dimensions

Width	14 mm
Height	80 mm
Depth	94 mm

Relay Module - PLC-RPT- 24UC/21-21 - 2900332

Technical data

Ambient conditions

Ambient temperature (operation)	-40 °C ... 60 °C
Ambient temperature (storage/transport)	-40 °C ... 85 °C

Coil side

Nominal input voltage U_N	24 V AC/DC
Typical input current at U_N	17.5 mA
Typical response time	8 ms
Typical release time	10 ms
Operating voltage display	Yellow LED
Protective circuit	Bridge rectifier Bridge rectifier

Contact side

Contact type	2 PDT
Contact material	AgNi
Maximum switching voltage	250 V AC/DC (The separating plate PLC-ATP should be installed for voltages larger than 250 V (L1, L2, L3) between identical terminal blocks in adjacent modules. Potential bridging is then carried out with FBST 8-PLC... or ...FBST 500...)
Minimum switching voltage	5 V AC/DC (at 10 mA)
Maximum inrush current	15 A (300 ms)
Min. switching current	10 mA (At 5 V)
Limiting continuous current	6 A
Interrupting rating (ohmic load) max.	140 W (at 24 V DC)
	85 W (at 48 V DC)
	60 W (at 60 V DC)
	44 W (at 110 V DC)
	60 W (at 220 V DC)
	1500 VA (for 250 V AC)
Switching capacity in acc. with DIN VDE 0660/IEC 60947	2 A (at 24 V, DC13)
	0.2 A (at 250 V, DC13)
	3 A (at 24 V, AC15)
	3 A (at 120 V, AC15)
	3 A (at 250 V, AC15)

General

Operating mode	100% operating factor
Degree of protection	RT III (Relay)
Mechanical service life	3×10^7 cycles
Inflammability class according to UL 94	V0
Designation	Standards/regulations

Relay Module - PLC-RPT- 24UC/21-21 - 2900332

Technical data

General

Standards/regulations	IEC 60664
	EN 50178
	IEC 62103
Rated surge voltage / insulation	6 kV (safe isolation: control side / contact side)
Pollution degree	2
Surge voltage category	III
Mounting position	any
Assembly instructions	In rows with zero spacing

Connection data

Connection method	Push-in connection
Stripping length	8 mm
Conductor cross section stranded min.	0.14 mm ²
Conductor cross section stranded max.	2.5 mm ²
Conductor cross section solid min.	0.14 mm ²
Conductor cross section solid max.	2.5 mm ²
Conductor cross section AWG/kcmil max	14
Conductor cross section AWG/kcmil min.	26

Articles in set

Relay socket - PLC-BPT- 24UC/21-21 - 2900284



14 mm PLC basic terminal block with push-in connection, without relay or solid-state relay, for mounting on DIN rail NS 35/7,5, 2 PDTs, input voltage 24 V AC/DC

Single relay - REL-MR- 24DC/21-21 - 2961192



Plug-in miniature power relay, with power contact, 2 PDTs, input voltage 24 V DC

Relay Module - PLC-RPT- 24UC/21-21 - 2900332

Classifications

eCl@ss

eCl@ss 4.0	27371001
eCl@ss 4.1	27371001
eCl@ss 5.0	27371001
eCl@ss 5.1	27371001
eCl@ss 6.0	27371001
eCl@ss 7.0	27371001
eCl@ss 8.0	27371001

ETIM

ETIM 4.0	EC000196
ETIM 5.0	EC000196

UNSPSC

UNSPSC 6.01	30211916
UNSPSC 7.0901	39121515
UNSPSC 11	39121515
UNSPSC 12.01	39121515
UNSPSC 13.2	39121515

Approvals

Approvals

Approvals

GL / UL Listed / cUL Listed / UL Recognized / cUL Recognized / cUL Listed / cULus Recognized / cULus Listed / cULus Listed / cULus Listed / null / null / null / null

Ex Approvals

Approvals submitted

Approval details

GL

Relay Module - PLC-RPT- 24UC/21-21 - 2900332

Approvals



UL Listed 

cUL Listed 

UL Recognized 

cUL Recognized 

cUL Listed 

cULus Recognized   US

cULus Listed   US

cULus Listed   US

cULus Listed

  US

Relay Module - PLC-RPT- 24UC/21-21 - 2900332

Approvals

Accessories

Accessories

Bridge

Continuous plug-in bridge - FBST 500-PLC RD - 2966786



Continuous plug-in bridge, Length: 500 mm, Color: red

Continuous plug-in bridge - FBST 500-PLC BU - 2966692



Continuous plug-in bridge, Length: 500 mm, Color: blue

Continuous plug-in bridge - FBST 500-PLC GY - 2966838



Continuous plug-in bridge, Length: 500 mm, Color: gray

Single plug-in bridge - FBST 6-PLC RD - 2966236



Single plug-in bridge, Length: 6 mm, Number of positions: 2, Color: red

Relay Module - PLC-RPT- 24UC/21-21 - 2900332

Accessories

Single plug-in bridge - FBST 6-PLC BU - 2966812



Single plug-in bridge, Length: 6 mm, Number of positions: 2, Color: blue

Single plug-in bridge - FBST 6-PLC GY - 2966825



Single plug-in bridge, Length: 6 mm, Number of positions: 2, Color: gray

Single plug-in bridge - FBST 6-PLC RD - 2966236



Single plug-in bridge, Length: 6 mm, Number of positions: 2, Color: red

Single plug-in bridge - FBST 6-PLC RD - 2966236



Single plug-in bridge, Length: 6 mm, Number of positions: 2, Color: red

Labeled terminal marker

Zack marker strip - ZB10,LGS:FORTL.ZAHLEN - 1053014



Zack marker strip, Strip, white, labeled, can be labeled with: Plotter, Printed horizontally: Consecutive numbers 1 - 10, 11 - 20, etc. up to 991 - 1000, Mounting type: Snap into tall marker groove, for terminal block width: 10.2 mm, Lettering field: 10.15 x 10.5 mm

Relay Module - PLC-RPT- 24UC/21-21 - 2900332

Accessories

Mounting rail

DIN rail, unperforated - NS 35/ 7,5 V2A UNPERF 2000MM - 0801377



DIN rail, unperforated, Width: 35 mm, Height: 7.5 mm, Length: 2000 mm, Color: silver

DIN rail perforated - NS 35/ 7,5 PERF 2000MM - 0801733



DIN rail, material: steel galvanized and passivated with a thick layer, perforated, height 7.5 mm, width 35 mm, length: 2000 mm

DIN rail, unperforated - NS 35/ 7,5 CU UNPERF 2000MM - 0801762



DIN rail, material: Copper, unperforated, height 7.5 mm, width 35 mm, length: 2 m

DIN rail, unperforated - NS 35/15 UNPERF 2000MM - 1201714



DIN rail, material: Steel, unperforated, height 15 mm, width 35 mm, length: 2 m

DIN rail, unperforated - NS 35/15 CU UNPERF 2000MM - 1201895



DIN rail, material: Copper, unperforated, 1.5 mm thick, height 15 mm, width 35 mm, length: 2 m

Relay Module - PLC-RPT- 24UC/21-21 - 2900332

Accessories

DIN rail, unperforated - NS 35/15-2,3 UNPERF 2000MM - 1201798



DIN rail, material: Steel, unperforated, 2.3 mm thick, height 15 mm, width 35 mm, length: 2 m

DIN rail, unperforated - NS 35/15 AL UNPERF 2000MM - 1201756



DIN rail, deep drawn, high profile, unperforated, 1.5 mm thick, material: aluminum, height 15 mm, width 35 mm, length 2000 mm

DIN rail perforated - NS 35/15 PERF 2000MM - 1201730



DIN rail, material: steel galvanized and passivated with a thick layer, perforated, height 15 mm, width 35 mm, length: 2000 mm

DIN rail, unperforated - NS 35/ 7,5 UNPERF 2000MM - 0801681



DIN rail, material: Steel, unperforated, height 7.5 mm, width 35 mm, length: 2 m

Partition plate

Separating plate - PLC-ATP BK - 2966841



Separating plate, 2 mm thick, required at the start and end of a PLC terminal strip. Furthermore, it is used for: visual separation of groups, safe isolation of different voltages of neighboring PLC relays in acc. with DIN VDE 0106-101, isolation

Relay Module - PLC-RPT- 24UC/21-21 - 2900332

Accessories

Power module

Power terminal block - PLC-ESK GY - 2966508



Power terminal block, for the input of up to four potentials, for mounting on NS 35/7.5

Screwdriver tools

Screwdriver - SZF 1-0,6X3,5 - 1204517



Actuation tool, for ST terminal blocks, also suitable for use as a bladed screwdriver, size: 0.6 x 3.5 x 100 mm, 2-component grip, with non-slip grip

Terminal marking

Zack marker strip - ZB10/WH-100:UNBEDRUCKT - 5060883



Zack marker strip, Strip, white, unlabeled, can be labeled with: Plotter, Mounting type: Snap into tall marker groove, for terminal block width: 10.2 mm, Lettering field: 10.15 x 10.5 mm

Zack marker strip - ZB 10:UNBEDRUCKT - 1053001



Zack marker strip, Strip, white, unlabeled, can be labeled with: Plotter, Mounting type: Snap into tall marker groove, for terminal block width: 10.2 mm, Lettering field: 10.5 x 10.15 mm

Drawings

Relay Module - PLC-RPT- 24UC/21-21 - 2900332

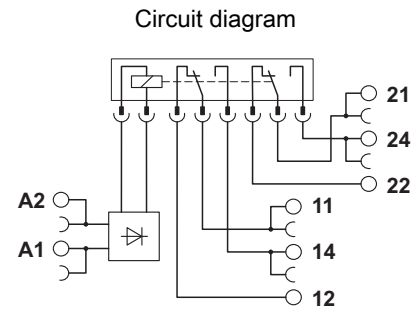
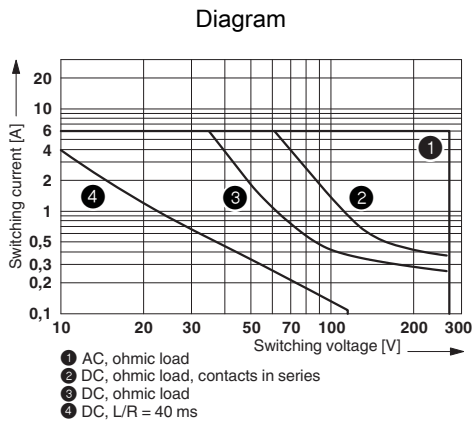

Interrupting rating

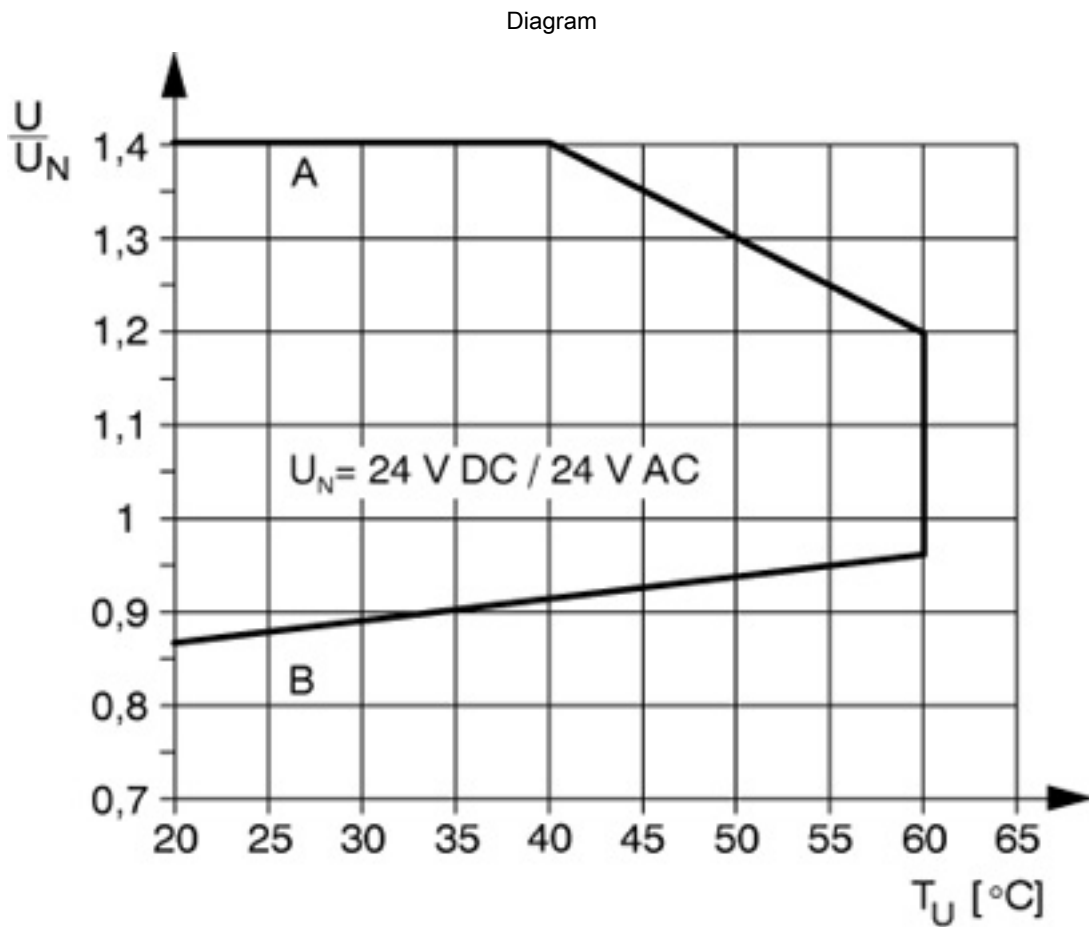

Curve A

Maximum permissible continuous voltage U_{max} with limiting continuous current on the contact side (see relevant technical data)

Relay Module - PLC-RPT- 24UC/21-21 - 2900332

Curve B

Minimum permissible operate voltage U_{op} after pre-excitation (see relevant technical data)

Phoenix Contact 2014 © - all rights reserved
<http://www.phoenixcontact.com>