

UPGRADE

Metallized Polypropylene Film Capacitor EZPQ series



Features

- High safety (Self-protecting function built-in)
- Long product life, High reliability
- Low loss, Low ESR
- Flame retardant (Case and sealing resin)
- High moisture resistance (85 °C, 85 %RH)
 - 330 V : 280 V, 1000 h
 - 380 V : 320 V, 1000 h
 - 600 V : 540 V, 1000 h
- RoHS compliant

Recommended applications

For AC filter

- Solar inverters
- UPS
- Industrial power supplies
- Inverter circuit in appliances (Air conditioners etc.)

Construction

- Dielectric : Polypropylene film
- Electrodes : Metallized dielectric with segmented pattern
- Plastic case : UL94 V-0
- Sealing : UL94 V-0
- Terminals : Tinned wires, 2-pin and 4-pin versions

Explanation of part number

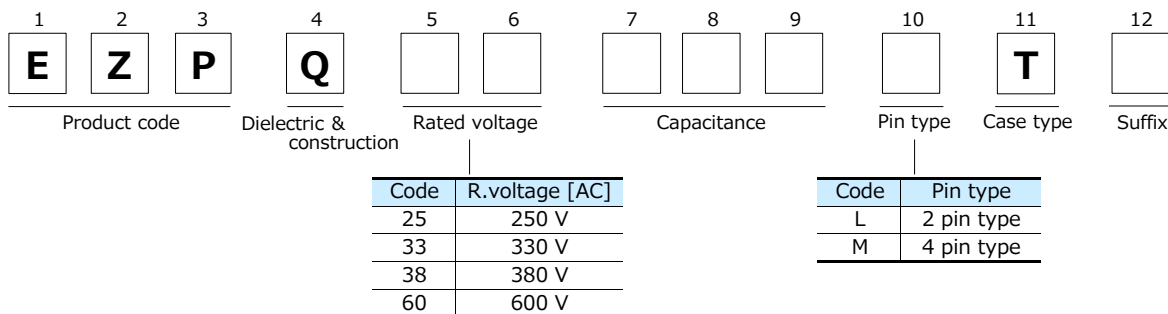

Specifications

Category temperature range*1	250 V	-40 °C to +85 °C
	330 V, 380 V 600 V	-40 °C to +105 °C
Rated voltage*2 [AC]	250 V 330 V, 380 V, 600 V (Derating of rated voltage by 1.0 %/°C at more than 85 °C)	
Rated capacitance	250 V	12, 22, 36 µF
	330 V	3 µF to 35 µF
	380 V	1 µF to 33 µF
	600 V	1 µF to 12 µF
Capacitance tolerance	±5%、±10 %	
Withstand voltage	250 V	Between terminals : Rated voltage (V) × 175 % 10 s Terminal to case : 2000 V [AC] (50 Hz or 60 Hz), 10 s
	330 V, 380 V 600 V	Between terminals : Rated voltage (V) × 150 % 60 s Terminal to case : 2000 V [AC] (50 Hz or 60 Hz), 10 s
Insulation resistance (IR)	CR ≥ 10,000 Ω·F (20 °C, 100 V [DC], 60 s)	

*1 : The temperature of capacitor surface (case).

*2 : Use for AC voltage only.

Dimensions

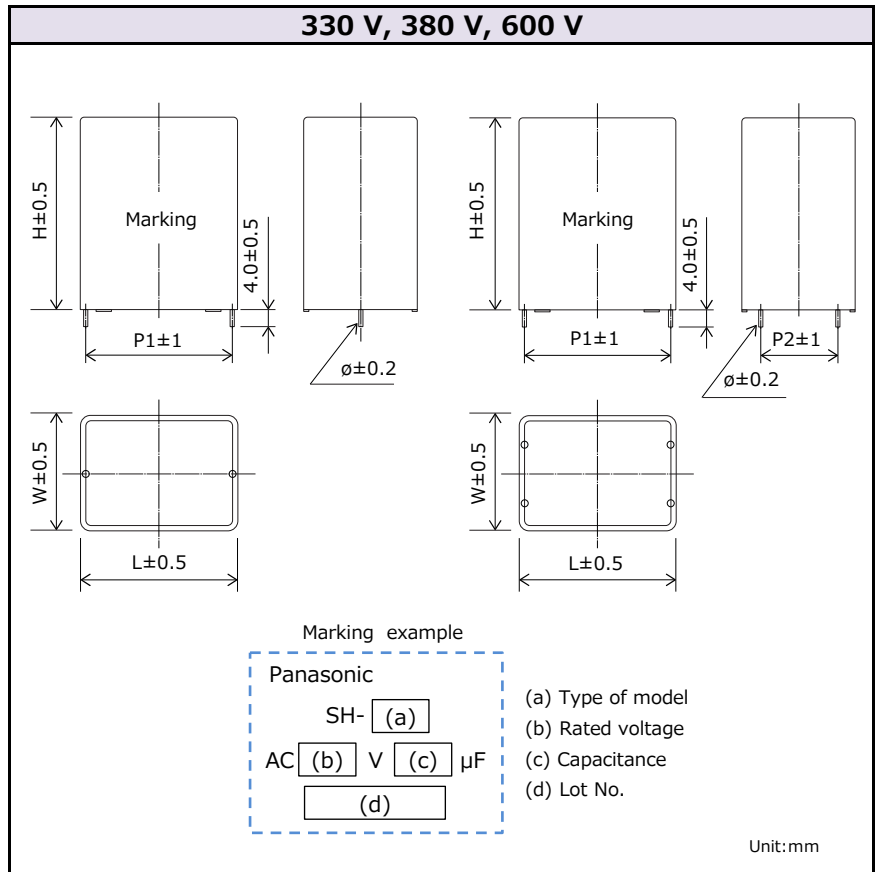
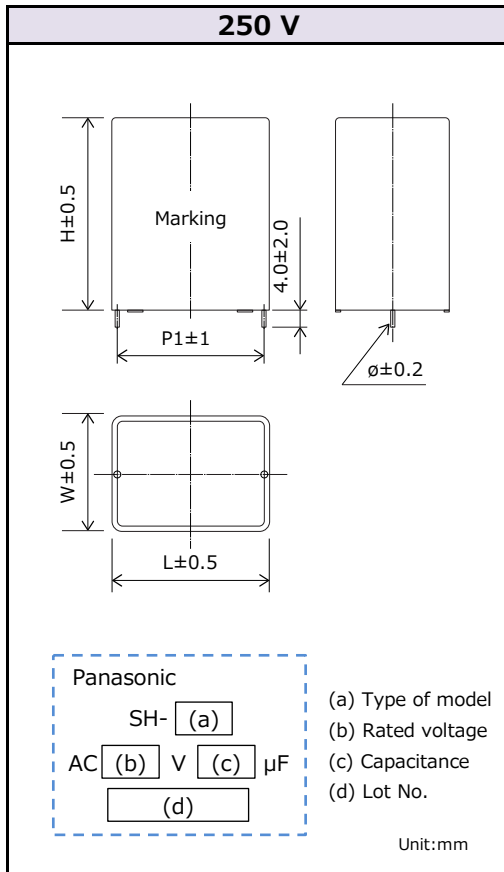

Rating · Dimensions · Quantity

■ Rated voltage [AC] : 250 V

Part No.	Capacitance (µF)	Dimensions (mm)						Mass (g)	Min. order Q'ty*1 (PCS)
		W	H	L	P1	P2	ø		
EZPQ25126LTA	12	22	36	48.5	45.6	—	1.2	80	800
EZPQ25226LTA	22	30	45	57.5	52.5	—	1.2	107	200
EZPQ25366LTA	36	35	56	57.5	52.5	—	1.2	136	200

*1 : Minimum order quantity consists of 4 packing units.

Rating · Dimensions · Quantity

■ Rated voltage [AC] : 330 V

Part No.	Cap. Tol. (%)	Cap. (μF)	Dimensions (mm)						dv/dt (V/μs)	Permissible current		ESR* ³ (mΩ)	Mass (g)	Min. order Q'ty* ⁴ (PCS)
			W	H	L	P1	P2	∅		Peak current* ¹ (A _{0-P})	RMS current* ² (A rms)			
EZPQ33305LTA	±5	3.0	17.0	34.5	41.5	37.5	-	1.0	23	69	5.0	23.0	29	1200
EZPQ33335LTA	±5	3.3	17.0	34.5	41.5	37.5	-	1.0	23	76	5.3	21.2	29	1200
EZPQ33355LTA	±5	3.5	17.0	34.5	41.5	37.5	-	1.0	23	81	5.6	20.0	29	1200
EZPQ33405LTA	±5	4.0	17.0	34.5	41.5	37.5	-	1.0	23	92	6.2	17.5	29	1200
EZPQ33455LTA	±5	4.5	17.0	34.5	41.5	37.5	-	1.0	23	104	6.8	15.9	29	1200
EZPQ33475LTA	±5	4.7	22.0	36.0	41.5	37.5	-	1.0	23	108	6.8	16.2	39	600
EZPQ33505LTA	±5	5.0	22.0	36.0	41.5	37.5	-	1.0	23	115	7.1	15.2	38	600
EZPQ33605LTA	±5	6.0	22.0	36.0	41.5	37.5	-	1.0	23	138	8.0	13.5	40	600
EZPQ33685LTA	±5	6.8	26.0	40.5	41.5	37.5	-	1.0	23	156	8.6	12.6	53	600
EZPQ33705LTA	±5	7.0	26.0	40.5	41.5	37.5	-	1.0	23	161	8.8	12.2	53	600
EZPQ33805LTA	±5	8.0	26.0	40.5	41.5	37.5	-	1.0	23	184	9.5	11.3	53	600
EZPQ33905LTA	±5	9.0	26.5	41.5	41.5	37.5	-	1.0	23	207	10.3	10.6	54	400
EZPQ33106LTB	±5	10.0	30.0	50.5	41.5	37.5	-	1.0	23	230	10.4	10.9	74	400
EZPQ33106LTC	±5	10.0	35.5	50.5	42.5	37.5	-	1.2	23	230	12.1	8.1	89	400
EZPQ33126LTA	±5	12.0	30.0	50.5	41.5	37.5	-	1.0	23	276	11.5	10.0	73	400
EZPQ33146LTA	±5	14.0	35.5	50.5	42.5	37.5	-	1.2	23	322	14.4	7.1	89	400
EZPQ33156LTA	±5	15.0	35.5	50.5	42.5	37.5	-	1.2	23	345	14.9	7.0	93	400
EZPQ33206LTB	±5	20.0	43.0	58.0	41.5	37.5	-	1.2	23	460	17.9	5.9	126	400
EZPQ33106MTA	±5	10.0	30.0	50.5	41.5	37.5	10.2	1.0	23	230	10.4	10.9	75	400
EZPQ33126MTA	±5	12.0	30.0	50.5	41.5	37.5	10.2	1.0	23	276	11.5	10.0	74	400
EZPQ33146MTA	±5	14.0	35.5	50.5	42.5	37.5	10.2	1.2	23	322	14.4	7.1	90	400
EZPQ33156MTA	±5	15.0	35.5	50.5	42.5	37.5	10.2	1.2	23	345	14.9	7.0	94	400
EZPQ33206MTA	±5	20.0	43.0	58.0	41.5	37.5	10.2	1.2	23	460	17.9	5.9	127	400
EZPQ33156LTB	±5	15.0	30.0	51.0	57.5	52.5	-	1.2	14	210	9.0	9.3	117	200
EZPQ33186MTA	±5	18.0	30.0	51.0	57.5	52.5	10.2	1.2	14	252	10.0	8.4	114	200
EZPQ33206MTB	±5	20.0	30.0	51.0	57.5	52.5	20.3	1.2	14	280	10.8	7.6	116	200
EZPQ33226MTA	±5	22.0	35.0	50.0	57.5	52.5	20.3	1.2	14	308	11.6	7.0	135	200
EZPQ33256MTB	±5	25.0	40.0	51.5	57.5	52.5	20.3	1.2	14	350	12.2	7.0	159	200
EZPQ33286MTA	±5	28.0	35.0	64.5	57.5	52.5	20.3	1.2	14	392	12.6	6.9	165	200
EZPQ33306MTB	±5	30.0	45.0	62.0	57.5	52.5	20.3	1.2	14	420	13.3	6.6	214	200
EZPQ33356MTA	±5	35.0	45.0	62.0	57.5	52.5	20.3	1.2	14	490	14.4	6.2	210	200

*1 : When rising temperature of capacitor surface by continuous peak current(included pulse current), use within limit specified for temperature of capacitor surface and self heating temperature rise.

*2 : Maximum RMS current @ 85°C , 10kHz Use within limit for self heating temperature rise at capacitor surface.

*3 : 20 °C, 10 kHz

*4 : Minimum order quantity consists of 4 packing units.

Rating · Dimensions · Quantity

■ Rated voltage [AC] : 380 V

Part No.	Cap. Tol. (%)	Cap. (μF)	Dimensions (mm)						dv/dt (V/μs)	Permissible current		ESR* ³ (mΩ)	Mass (g)	Min. order Q'ty* ⁴ (PCS)
			W	H	L	P1	P2	∅		Peak current* ¹ (A _{0-P})	RMS current* ² (A rms)			
EZPQ38105LTA	±5	1.0	15.0	29.0	41.5	37.5	-	1.0	50	50	2.1	71.6	22	1200
EZPQ38155LTA	±5	1.5	15.0	29.0	41.5	37.5	-	1.0	50	75	2.8	48.8	22	1200
EZPQ38205LTA	±5	2.0	15.0	29.0	41.5	37.5	-	1.0	50	100	3.5	36.6	22	1200
EZPQ38225LTB	±5	2.2	15.0	29.0	41.5	37.5	-	1.0	50	110	3.8	33.2	22	1200
EZPQ38255LTB	±5	2.5	15.0	29.0	41.5	37.5	-	1.0	50	125	4.1	29.2	22	1200
EZPQ38305LTA	±5	3.0	17.0	34.5	41.5	37.5	-	1.0	50	150	4.8	24.4	29	1200
EZPQ38335LTA	±5	3.3	17.0	34.5	41.5	37.5	-	1.0	50	165	5.2	22.1	29	1200
EZPQ38355LTA	±5	3.5	17.0	34.5	41.5	37.5	-	1.0	50	175	5.4	20.9	29	1200
EZPQ38405LTA	±5	4.0	22.0	36.0	41.5	37.5	-	1.0	50	200	6.0	18.3	39	600
EZPQ38455LTA	±5	4.5	22.0	36.0	41.5	37.5	-	1.0	50	225	6.5	16.7	39	600
EZPQ38475LTA	±5	4.7	22.0	36.0	41.5	37.5	-	1.0	50	235	6.7	16.0	39	600
EZPQ38505LTA	±5	5.0	22.0	36.0	41.5	37.5	-	1.0	50	250	7.1	15.1	40	600
EZPQ38555LTA	±5	5.5	26.0	40.5	41.5	37.5	-	1.0	50	275	7.4	14.4	53	600
EZPQ38605LTA	±5	6.0	26.0	40.5	41.5	37.5	-	1.0	50	300	7.8	13.7	53	600
EZPQ38705LTA	±5	7.0	26.0	40.5	41.5	37.5	-	1.0	50	350	8.7	12.2	53	600
EZPQ38755LTA	±5	7.5	26.5	41.5	41.5	37.5	-	1.0	50	375	9.1	11.8	54	400
EZPQ38805LTC	±10	8.0	26.5	41.5	41.5	37.5	-	1.0	70	560	10.0	11.9	55	400
EZPQ38805LTD	±5	8.0	27.5	42.0	41.5	37.5	-	1.0	50	400	9.2	11.9	56	600
EZPQ38855LTA	±5	8.5	30.0	50.5	41.5	37.5	-	1.0	50	425	9.5	11.7	74	400
EZPQ38905LTA	±5	9.0	30.0	50.5	41.5	37.5	-	1.0	50	450	9.8	11.4	74	400
EZPQ38955LTA	±5	9.5	30.0	50.5	41.5	37.5	-	1.0	50	475	10.1	11.0	74	400
EZPQ38106LTA	±5	10.0	30.0	50.5	41.5	37.5	-	1.0	50	500	10.4	10.8	73	400
EZPQ38126LTA	±5	12.0	30.0	56.0	41.5	37.5	-	1.2	50	600	12.7	8.0	83	400
EZPQ38156LTA	±5	15.0	38.0	57.5	41.5	37.5	-	1.2	50	750	14.6	7.1	108	400
EZPQ38805MTA	±5	8.0	27.5	42.0	41.5	37.5	10.2	1.0	50	400	9.2	11.9	57	600
EZPQ38855MTA	±5	8.5	30.0	50.5	41.5	37.5	10.2	1.0	50	425	9.5	11.7	75	400
EZPQ38905MTA	±5	9.0	30.0	50.5	41.5	37.5	10.2	1.0	50	450	9.8	11.4	75	400
EZPQ38955MTA	±5	9.5	30.0	50.5	41.5	37.5	10.2	1.0	50	475	10.1	11.0	75	400
EZPQ38106MTA	±5	10.0	30.0	50.5	41.5	37.5	10.2	1.0	50	500	10.4	10.8	74	400
EZPQ38126MTA	±5	12.0	30.0	56.0	41.5	37.5	10.2	1.2	50	600	12.7	8.0	84	400
EZPQ38156MTB	±5	15.0	38.0	57.5	41.5	37.5	10.2	1.2	50	750	14.6	7.1	109	400
EZPQ38106LTB	±5	10.0	25.0	40.0	57.5	52.5	-	1.2	30	300	7.1	13.3	75	600
EZPQ38116LTA	±5	11.0	30.0	51.0	57.5	52.5	-	1.2	30	330	7.6	12.2	120	200
EZPQ38126LTB	±5	12.0	30.0	51.0	57.5	52.5	-	1.2	30	360	8.1	11.4	119	200
EZPQ38156LTB	±5	15.0	30.0	51.0	57.5	52.5	-	1.2	30	450	9.5	9.3	114	200
EZPQ38156MTC	±5	15.0	30.0	51.0	57.5	52.5	10.2	1.2	30	450	9.5	9.3	115	200
EZPQ38166MTA	±5	16.0	30.0	51.0	57.5	52.5	10.2	1.2	30	480	9.9	8.9	115	200
EZPQ38186MTA	±5	18.0	30.0	51.0	57.5	52.5	10.2	1.2	30	540	10.8	8.1	115	200
EZPQ38206MTA	±5	20.0	35.0	50.0	57.5	52.5	20.3	1.2	30	600	11.7	7.5	133	200
EZPQ38226MTA	±5	22.0	35.0	56.0	57.5	52.5	20.3	1.2	30	660	11.9	7.5	147	200
EZPQ38246MTC	±5	24.0	35.0	64.5	57.5	52.5	20.3	1.2	30	720	12.2	7.6	166	200
EZPQ38306MTA	±5	30.0	45.0	62.0	57.5	52.5	20.3	1.2	30	900	14.2	6.6	211	200
EZPQ38336MTA	±5	33.0	45.0	62.0	57.5	52.5	20.3	1.2	30	990	15.0	6.2	206	200

*1 : When rising temperature of capacitor surface by continuous peak current(included pulse current), use within limit specified for temperature of capacitor surface and self heating temperature rise.

*2 : Maximum RMS current @ 85°C , 10kHz Use within limit for self heating temperature rise at capacitor surface.

*3 : 20 °C, 10 kHz

*4 : Minimum order quantity consists of 4 packing units.

Rating · Dimensions · Quantity

■ Rated voltage [AC] : 600 V

NEW Part No.	Cap. Tol. (%)	Cap. (μF)	Dimensions (mm)						dv/dt (V/μs)	Permissible current		ESR ^{*3} (mΩ)	Mass (g)	Min. order Qty ^{*4} (PCS)
			W	H	L	P1	P2	∅		Peak current ^{*1} (A _{0-P})	RMS current ^{*2} (A rms)			
EZPQ60105LTA	±10	1.0	15.0	29.0	41.5	37.5	-	1.0	110	110	6.5	26.6	25	1200
EZPQ60155LTA	±10	1.5	17.0	34.5	41.5	37.5	-	1.0	110	165	7.9	18.7	34	1200
EZPQ60225LTA	±10	2.2	26.0	40.5	41.5	37.5	-	1.0	110	242	9.6	13.3	61	600
EZPQ60335MTB	±10	3.3	27.5	42.0	41.5	37.5	10.2	1.0	110	363	11.8	9.4	64	600
EZPQ60475MTA	±10	4.7	35.5	50.5	42.5	37.5	10.2	1.2	110	517	14.0	7.0	104	400
EZPQ60475MTB	±10	4.7	30.0	51.0	57.5	52.5	10.2	1.2	70	329	10.6	7.3	124	200
EZPQ60685MTA	±10	6.8	30.0	51.0	57.5	52.5	20.3	1.2	70	476	12.8	5.9	120	200
EZPQ60705MTA	±10	7.0	30.0	51.0	57.5	52.5	20.3	1.2	70	490	13.0	5.6	119	200
EZPQ60106MTA	±10	10.0	35.0	64.5	57.5	52.5	20.3	1.2	70	700	15.5	4.7	166	200
EZPQ60126MTA	±10	12.0	45.0	62.0	57.5	52.5	20.3	1.2	70	840	17.0	4.3	215	200

*1 : When rising temperature of capacitor surface by continuous peak current(included pulse current), use within limit specified for temperature of capacitor surface and self heating temperature rise.

*2 : Maximum RMS current @ 85°C , 10kHz Use within limit for self heating temperature rise at capacitor surface.

*3 : 20 °C, 10 kHz

*4 : Minimum order quantity consists of 4 packing units.

Characteristics data

■ Rated voltage [AC] : 330 V (Lead pitch 37.5 mm)

Electrical characteristics <Typical data >

Temperature characteristics

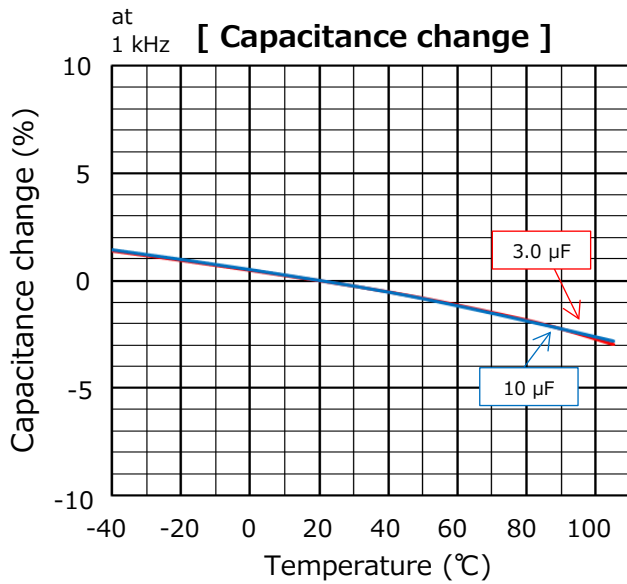

Frequency characteristics

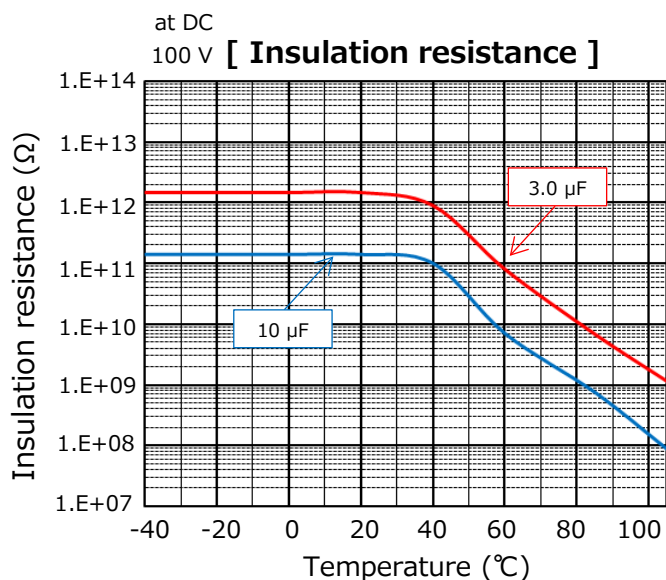
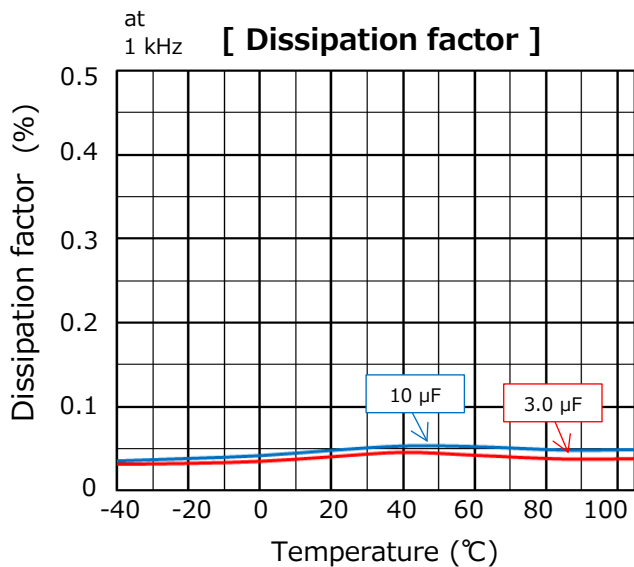
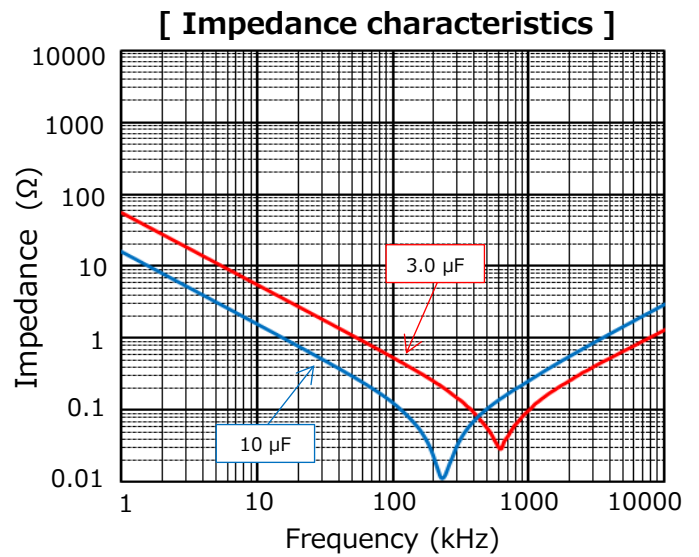

Characteristics data

■ **Rated voltage [AC] : 330 V (Lead pitch 37.5 mm)**

Applicable specifications

[Permissible Current]

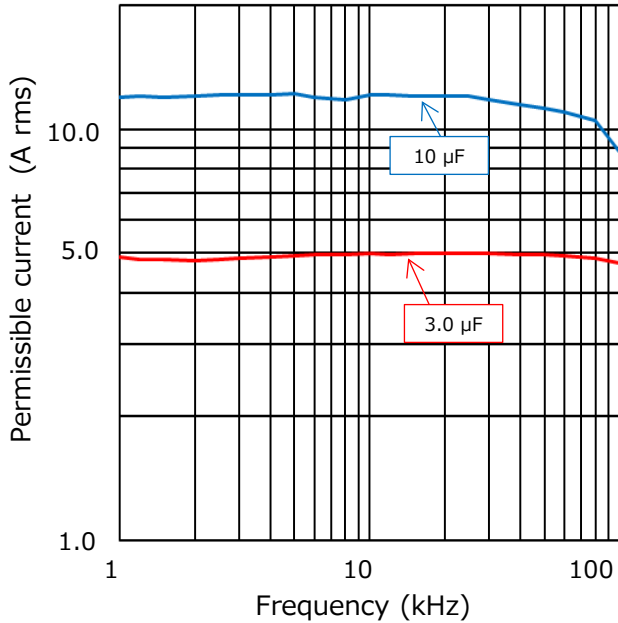

[Lifetime expectancy]

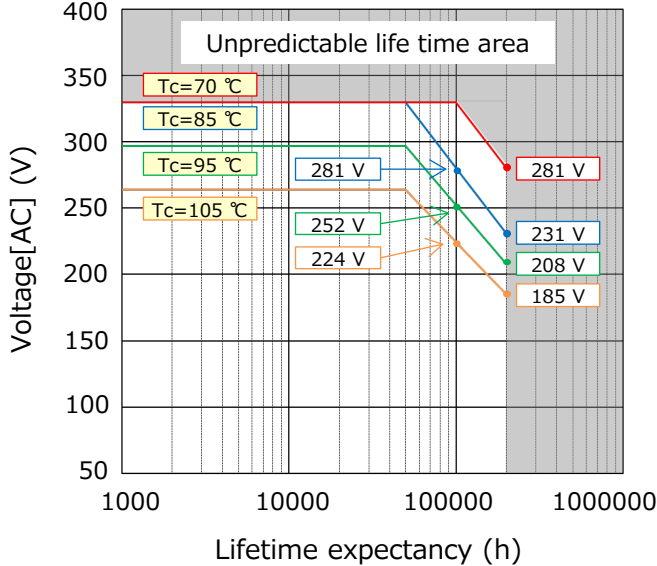

Permissible pulse current (dV/dt)
(Max. 10000 cycles)

R. voltage [AC] (V)	Pitch (mm)	Capacitance (µF)	Code	dV/dt (V/µs)	Current (Ao-p)
330	37.5	3.0	305	23	69.0
		5.0	505		115.0
		6.0	605		138.0
		8.0	805		184.0
		10.0	106		230.0
		15.0	156		345.0
		20.0	206		460.0

[Permissible Current Derating by Temperature]

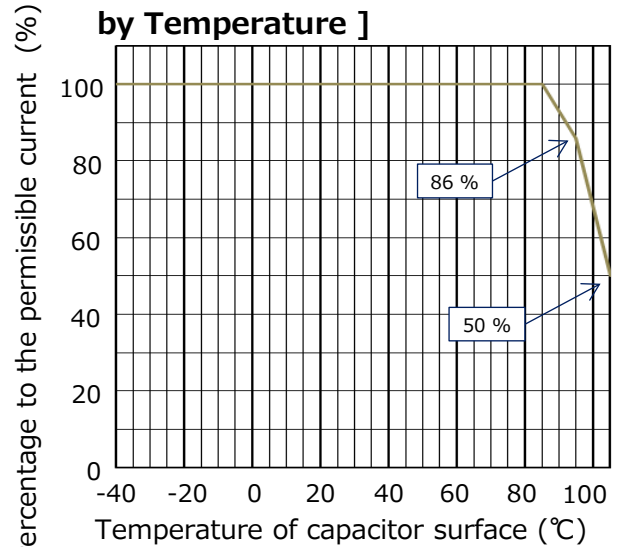

[Voltage Derating by Temperature]

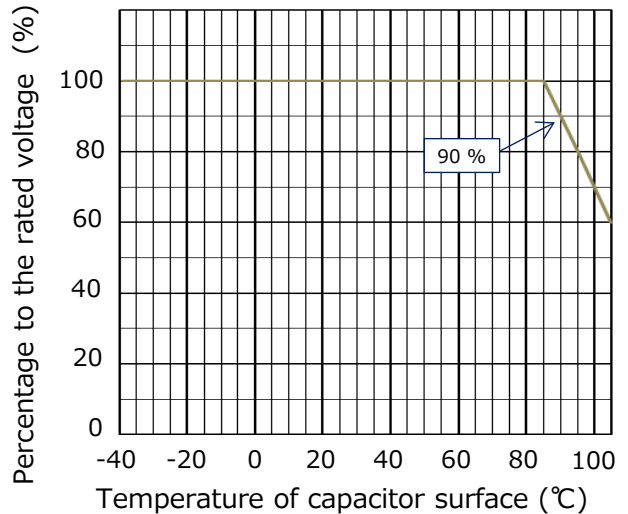

[Self Heating Derating by Temperature]

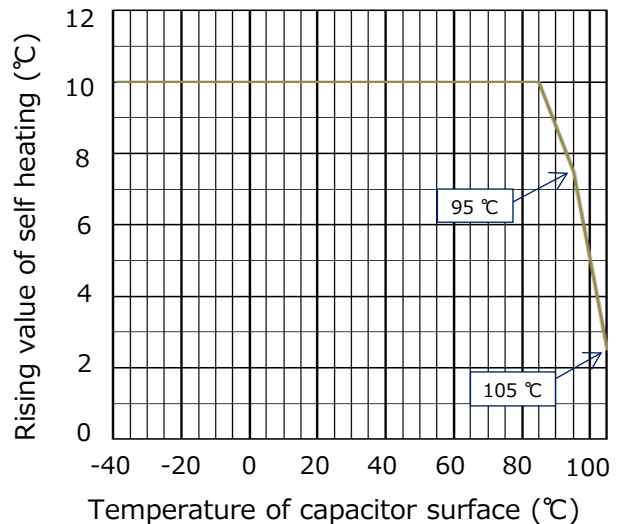

Characteristics data

■ Rated voltage [AC] : 330 V (Lead pitch 52.5 mm)

Electrical characteristics <Typical data >

Temperature characteristics

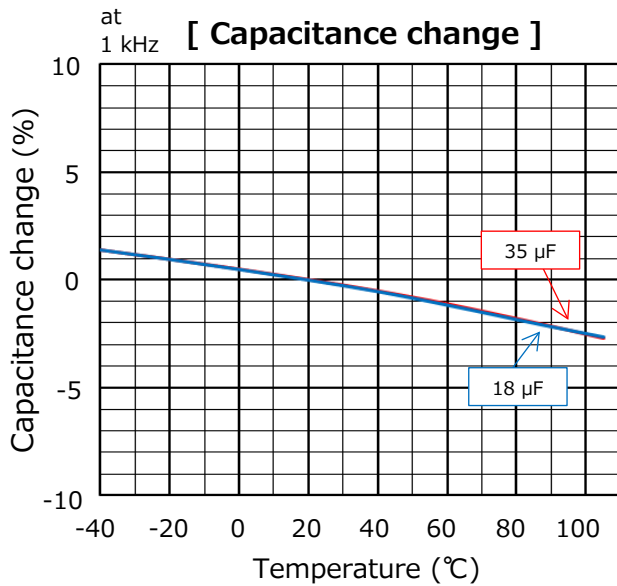

Frequency characteristics

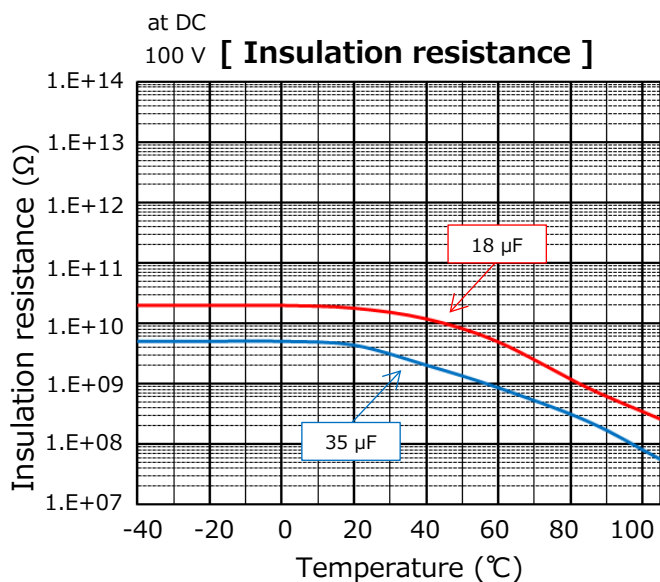
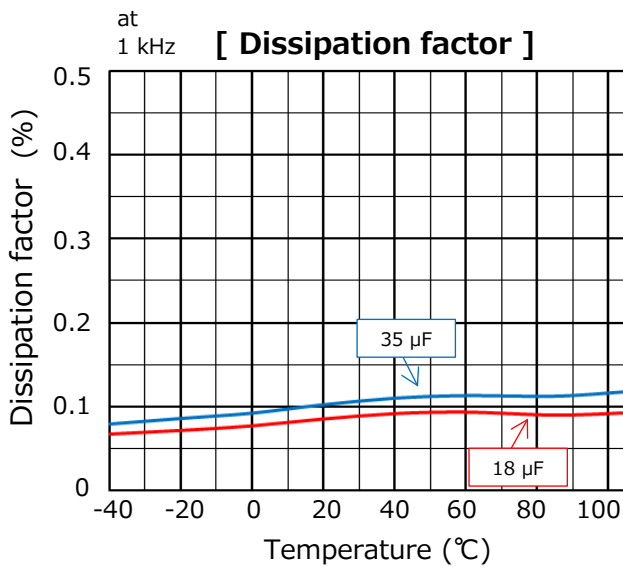
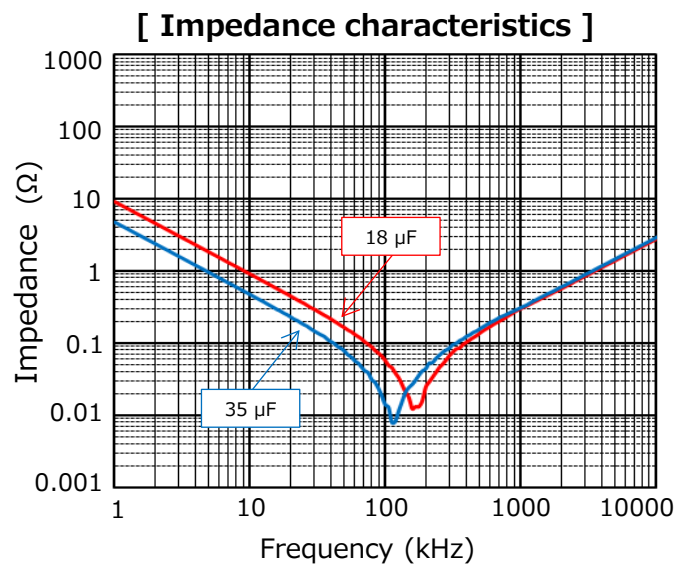

Characteristics data

■ **Rated voltage [AC] : 330 V (Lead pitch 52.5 mm)**

Applicable specifications

[Permissible Current]

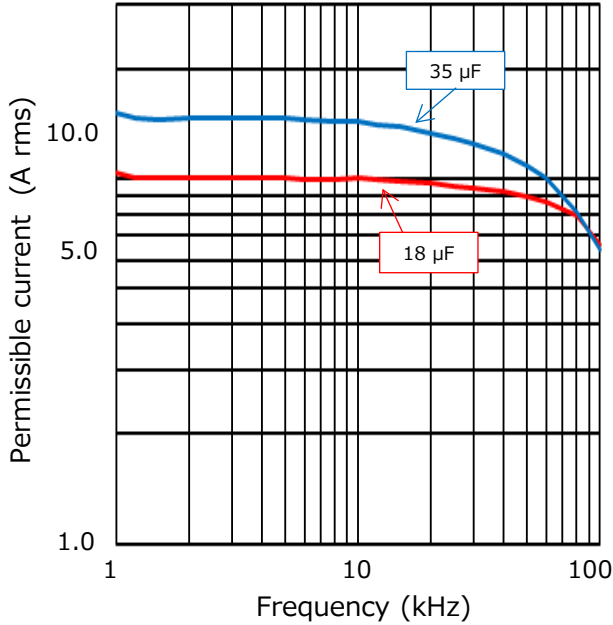

[Permissible Current Derating by Temperature]

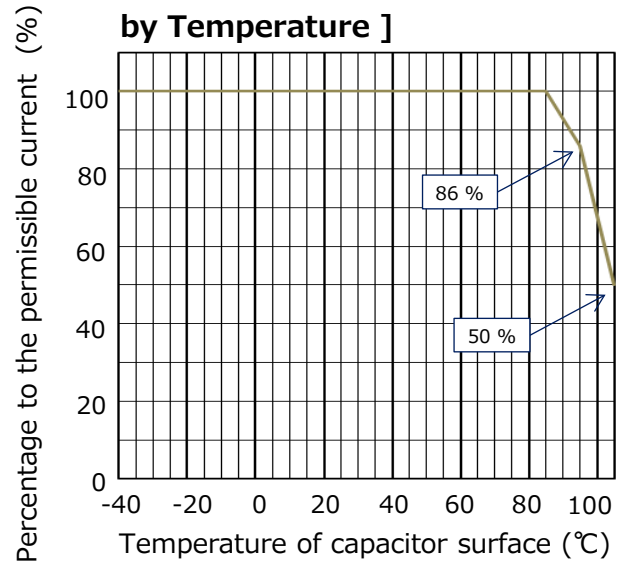

[Lifetime expectancy]

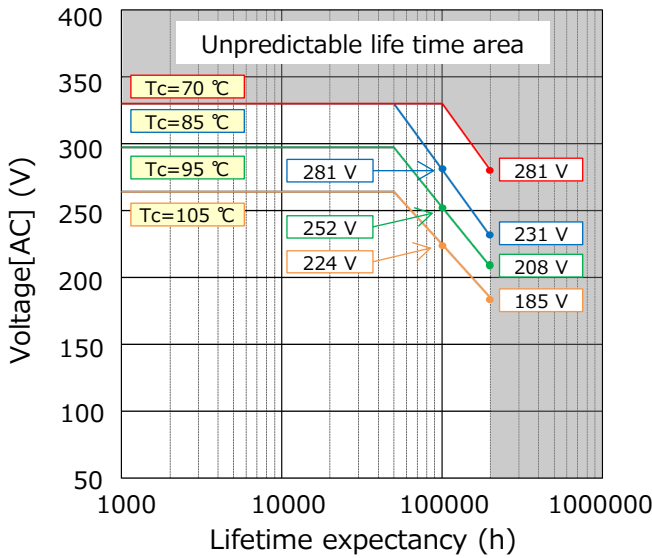

[Voltage Derating by Temperature]

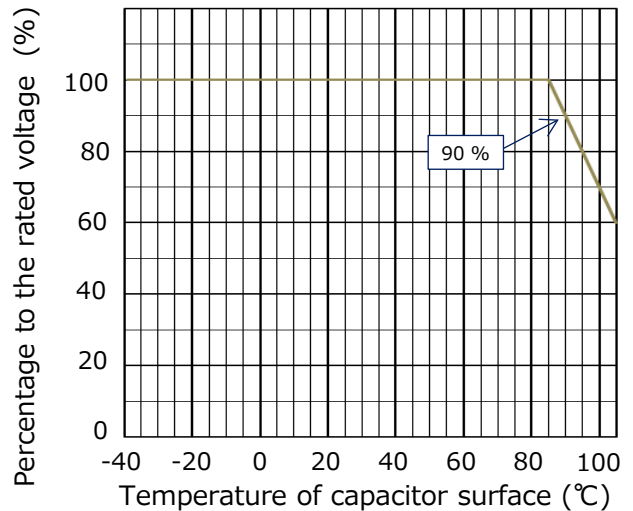

Permissible pulse current (dV/dt)
(Max. 10000 cycles)

R. voltage [AC] (V)	Pitch (mm)	Capacitance (µF)	Code	dV/dt (V/µs)	Current (Ao-p)
330	52.5	15.0	156	14	210.0
		18.0	186		252.0
		20.0	206		280.0
		22.0	226		308.0
		25.0	256		350.0
		30.0	306		420.0
		35.0	356		490.0

[Self Heating Derating by Temperature]

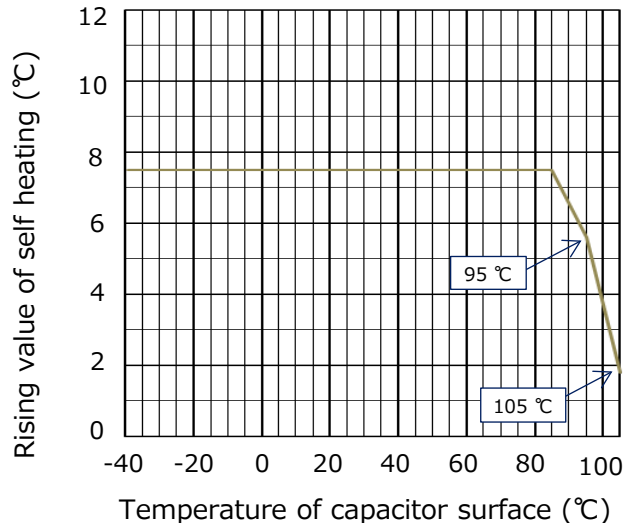

Characteristics data

■ Rated voltage [AC] : 380 V (Lead pitch 37.5 mm)

Electrical characteristics <Typical data >

Temperature characteristics

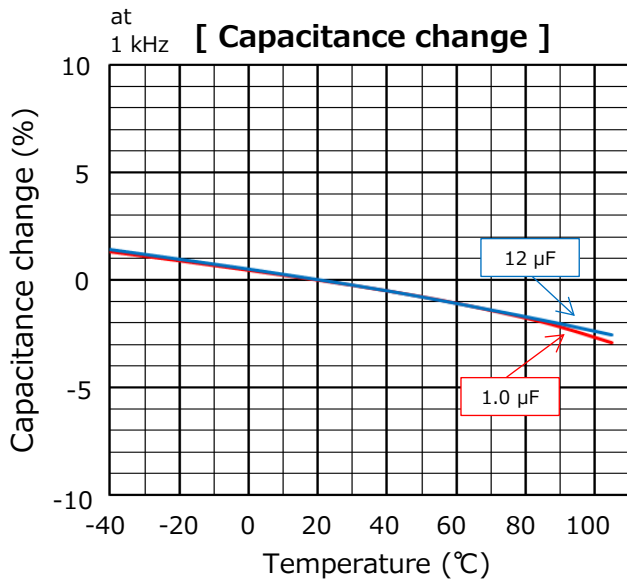

Frequency characteristics

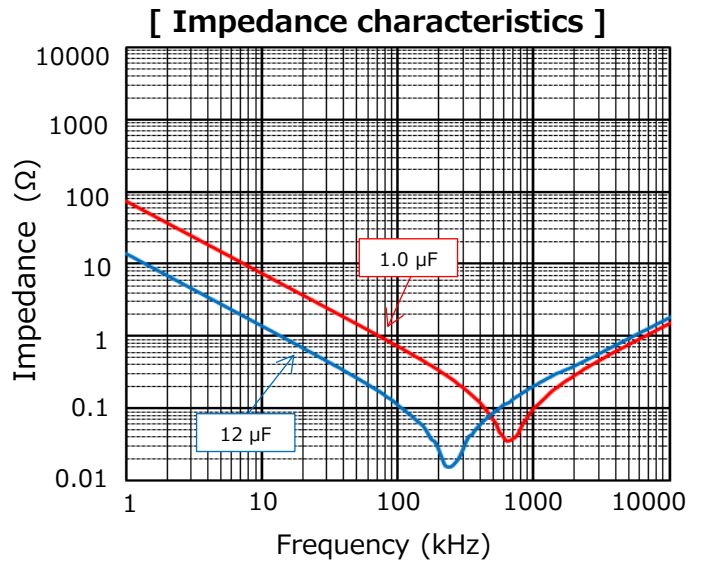

at 1 kHz [Dissipation factor]

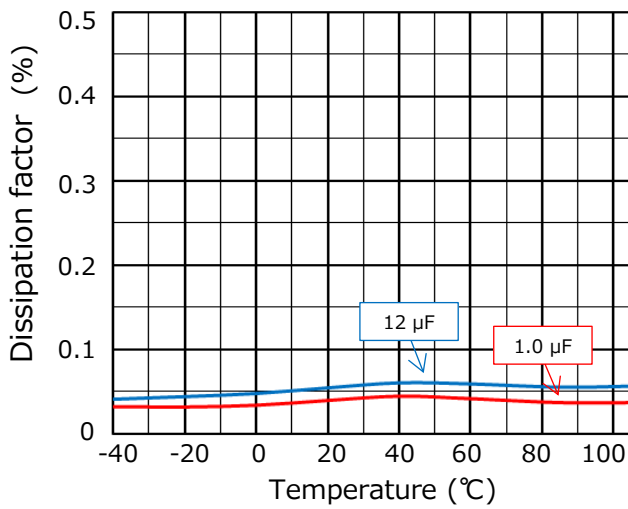

at DC 100 V [Insulation resistance]

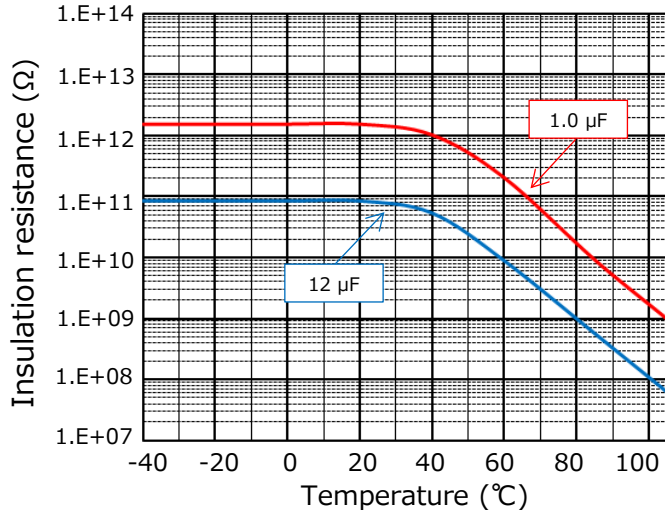

Characteristics data

■ **Rated voltage [AC] : 380 V (Lead pitch 37.5 mm)**

Applicable specifications

[Permissible Current]

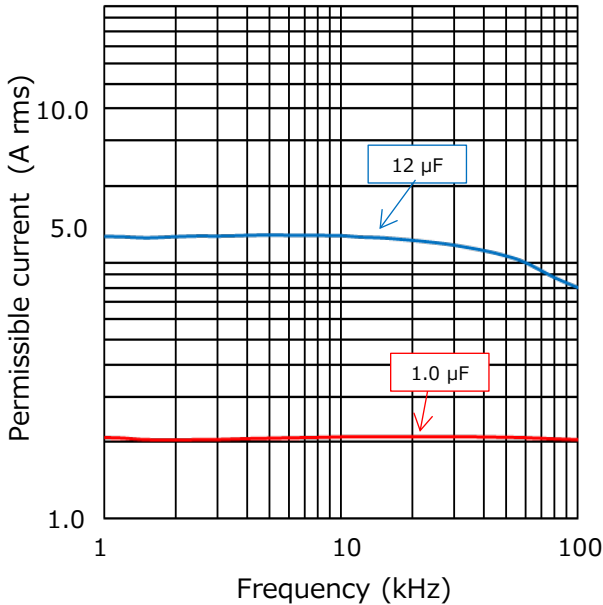

[Permissible Current Derating by Temperature]

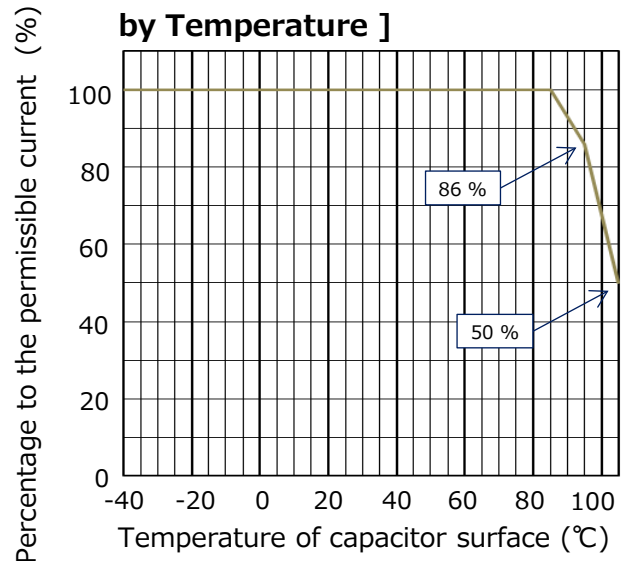

[Lifetime expectancy]

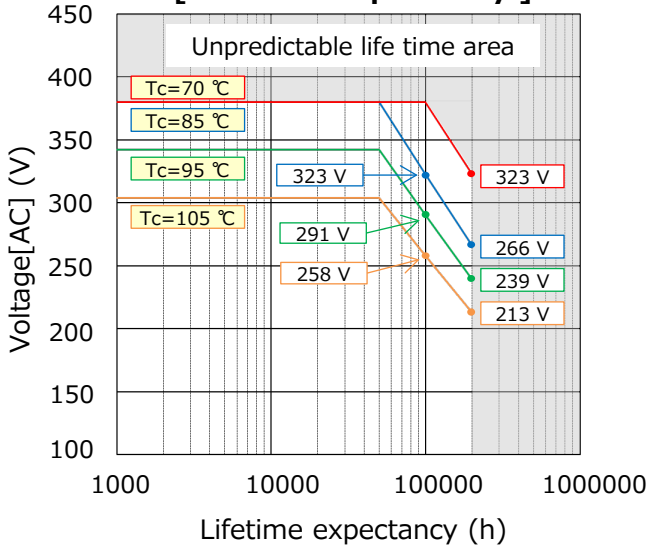

[Voltage Derating by Temperature]

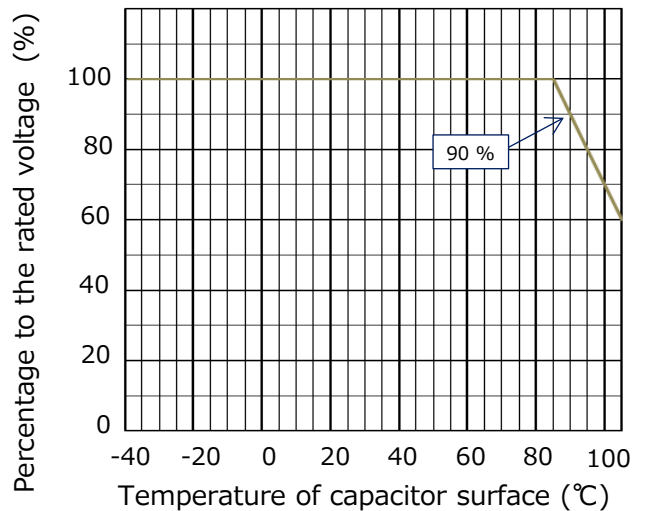

Permissible pulse current (dV/dt)
(Max. 10000 cycles)

R. voltage [AC] (V)	Pitch (mm)	Capacitance (μF)	Code	dV/dt (V/μs)	Current (Ao-p)
380	37.5	1.0	105	50	50.0
		3.0	305		150.0
		5.0	505		250.0
		6.0	605		300.0
		8.0	805		400.0
		10.0	106		500.0
		15.0	156		750.0

[Self Heating Derating by Temperature]

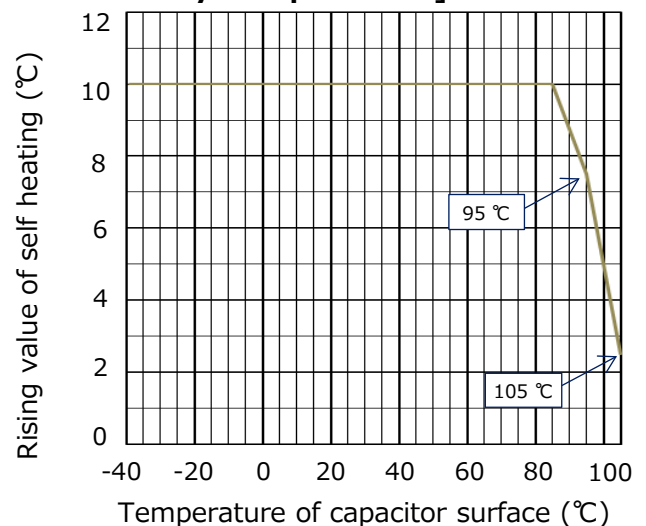

Characteristics data

■ Rated voltage [AC] : 380 V (Lead pitch 52.5 mm)

Electrical characteristics <Typical data >

Temperature characteristics

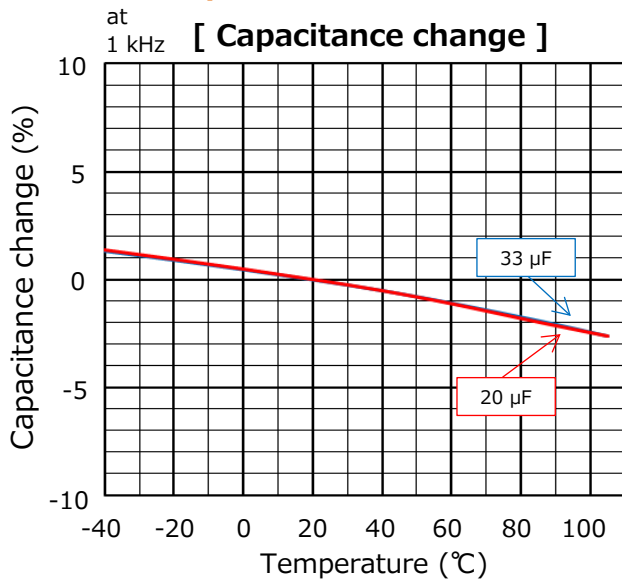

Frequency characteristics

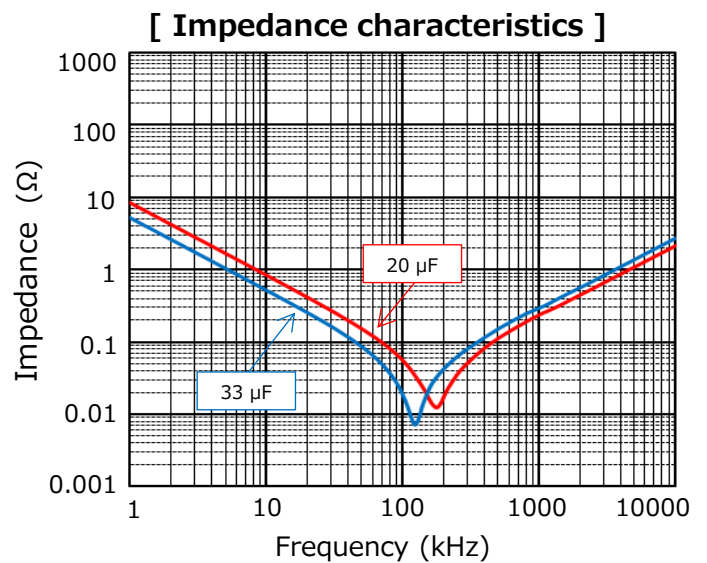

at 1 kHz [Dissipation factor]

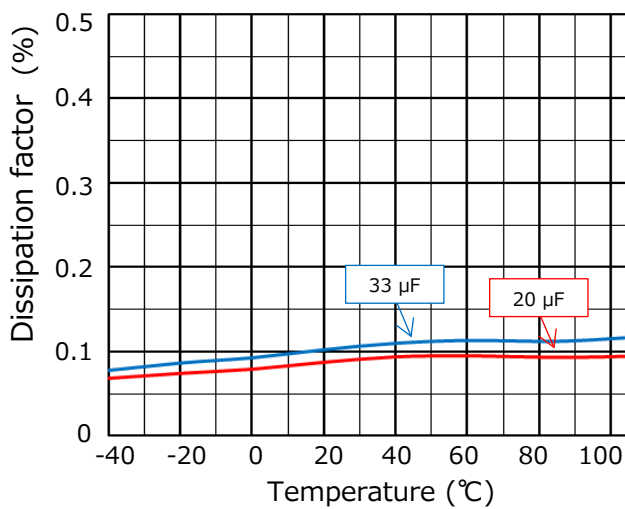

at DC 100 V [Insulation resistance]

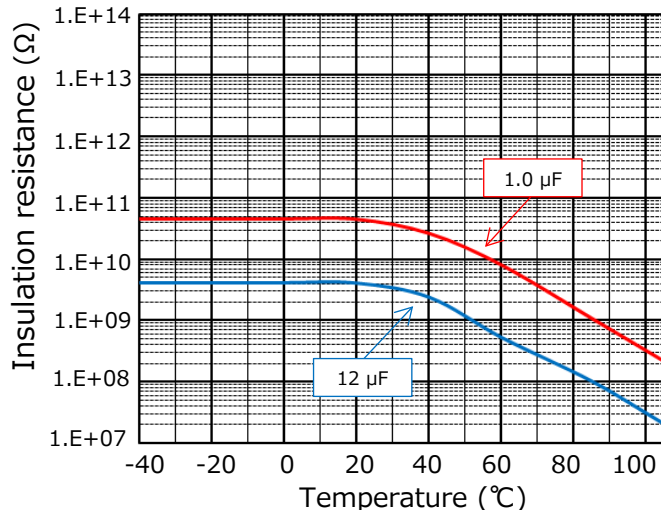

Characteristics data

■ Rated voltage [AC] : 380 V (Lead pitch 52.5 mm)

Applicable specifications

[Permissible Current]

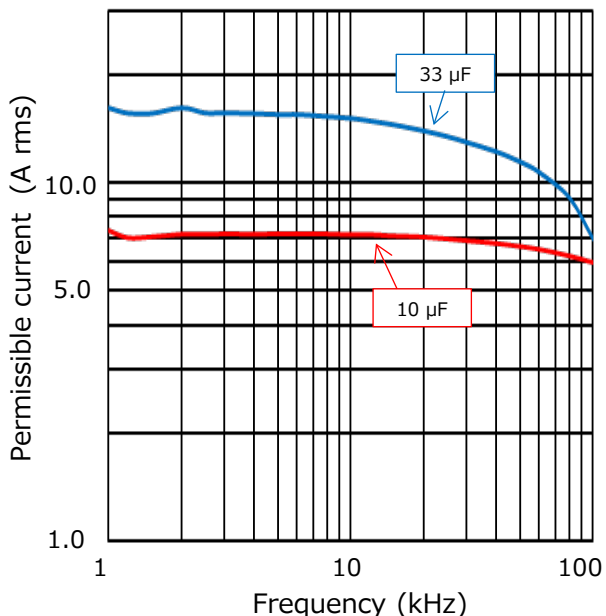

[Permissible Current Derating by Temperature]

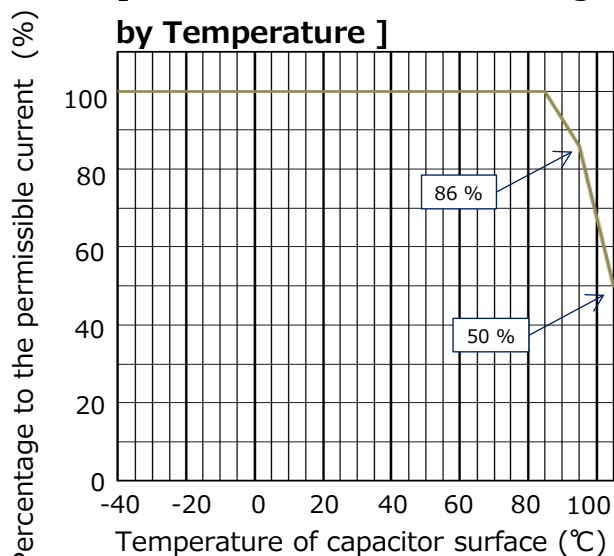

[Lifetime expectancy]

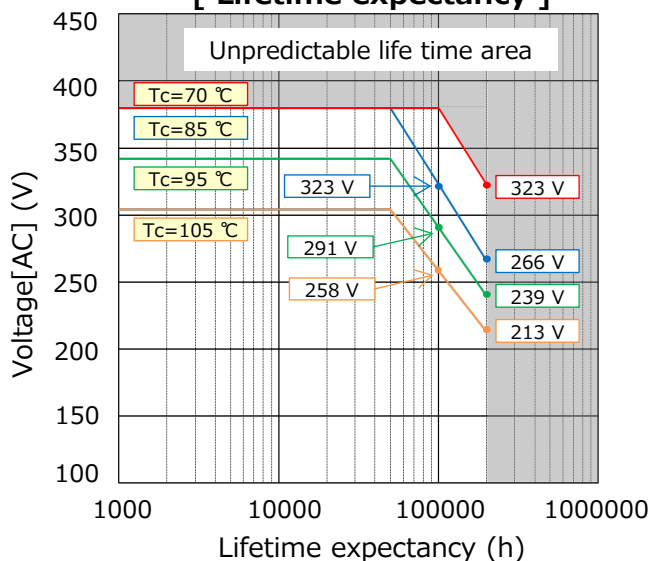

[Voltage Derating by Temperature]

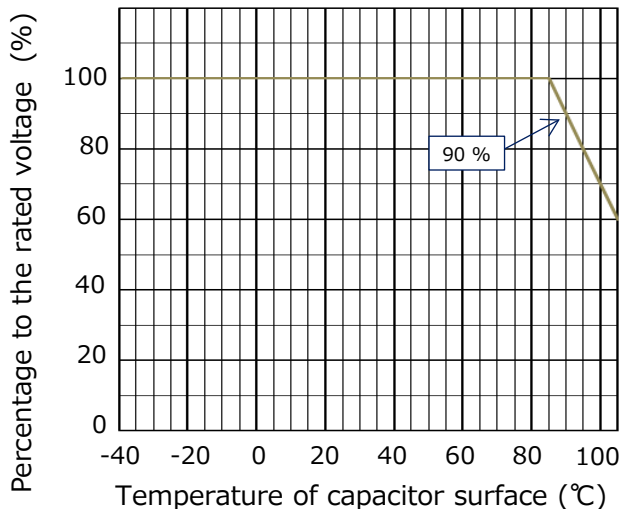

Permissible pulse current (dV/dt)
(Max. 10000 cycles)

R. voltage [AC] (V)	Pitch (mm)	Capacitance (µF)	Code	dV/dt (V/µs)	Current (Ao-p)
380	52.5	10.0	106	30	300.0
		12.0	126		360.0
		15.0	156		450.0
		20.0	206		600.0
		24.0	246		720.0
		30.0	306		900.0
		33.0	336		990.0

[Self Heating Derating by Temperature]

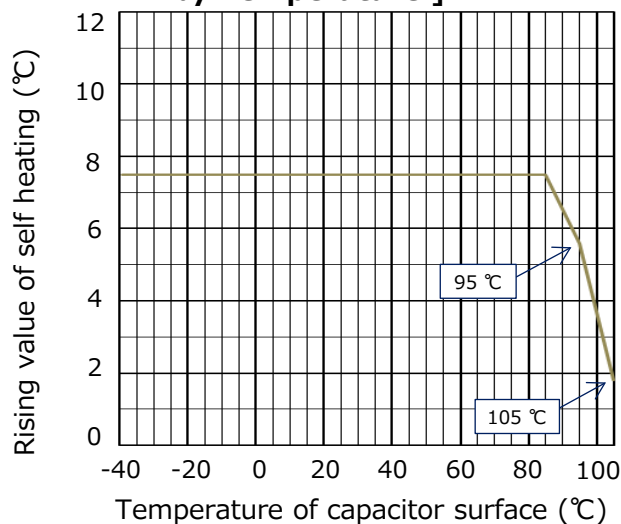

Characteristics data

■ Rated voltage [AC] : 600 V (Lead pitch 37.5 mm)

Electrical characteristics <Typical data >

Temperature characteristics

at 1 kHz [Capacitance change]

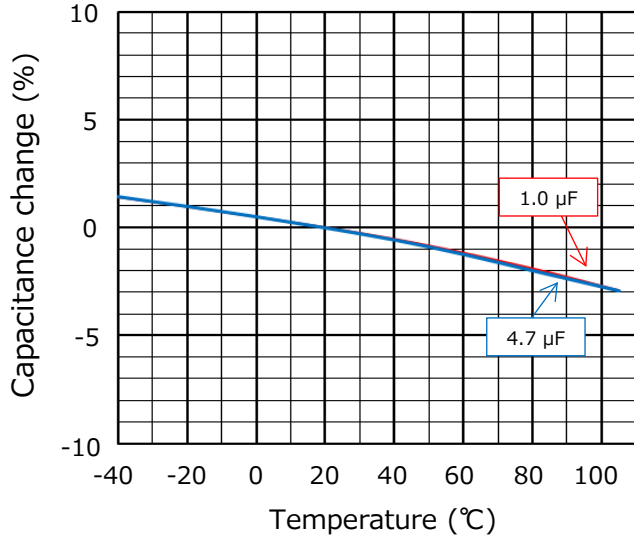

Frequency characteristics

[Impedance characteristics]

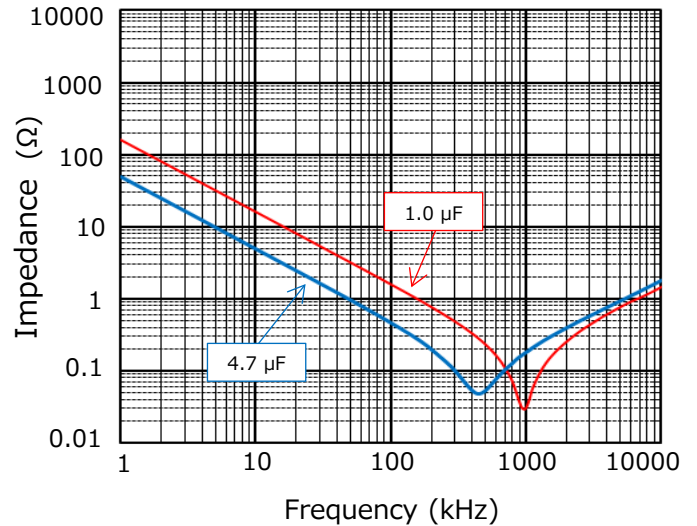

at 1 kHz [Dissipation factor]

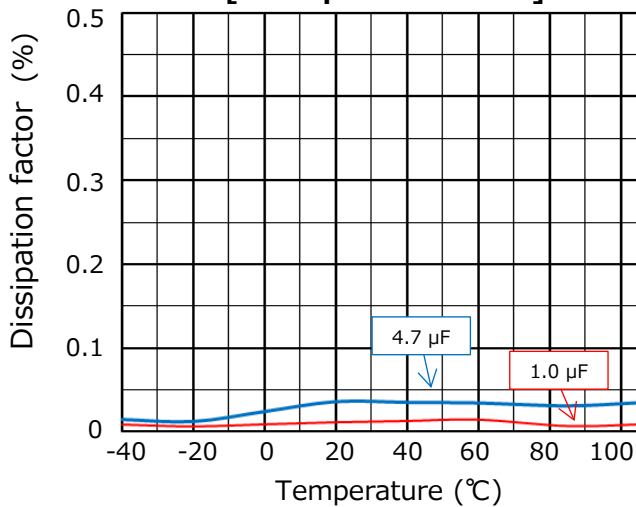

at DC 100 V [Insulation resistance]

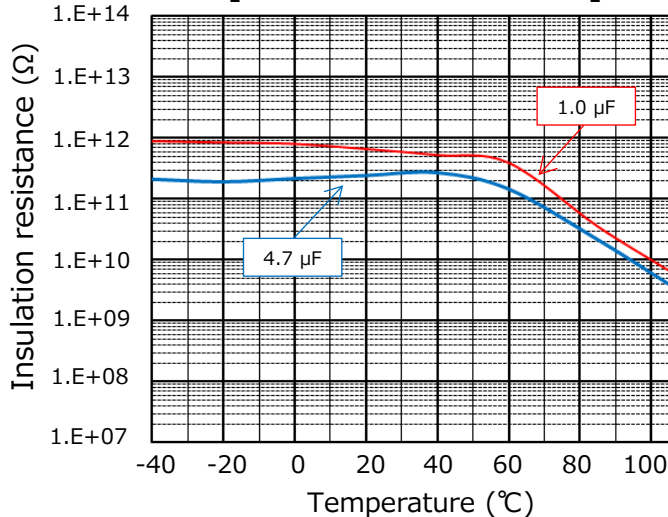

Characteristics data

■ **Rated voltage [AC] : 600 V (Lead pitch 37.5 mm)**

Applicable specifications

[Permissible Current]

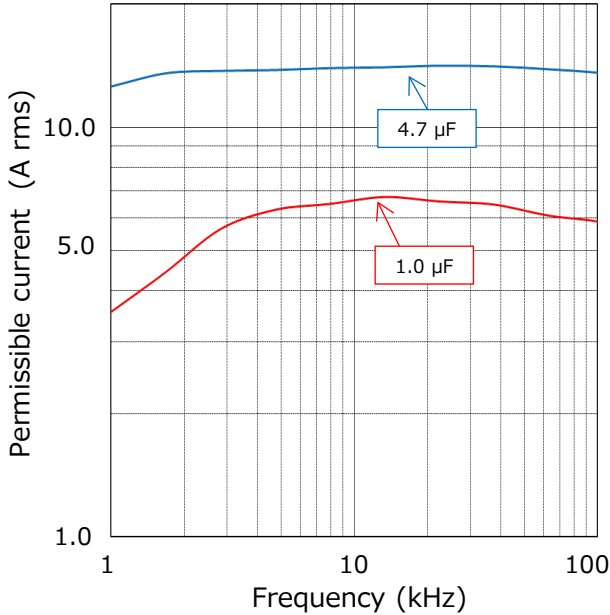

[Lifetime expectancy]

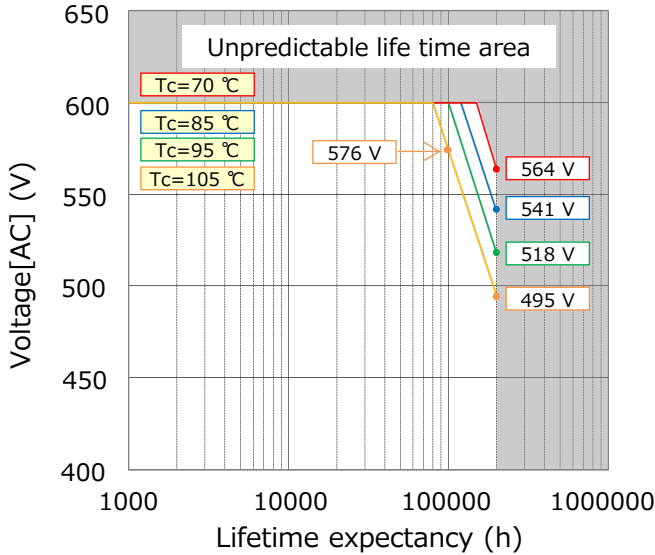

Permissible pulse current (dV/dt)
(Max. 10000 cycles)

R. voltage [AC] (V)	Pitch (mm)	Capacitance (μF)	Code	dV/dt (V/μs)	Current (Ao-p)
600	37.5	1.0	105	110	110.0
		1.5	155		165.0
		2.2	225		242.0
		3.3	335		363.0
		4.7	475		517.0

[Permissible Current Derating by Temperature]

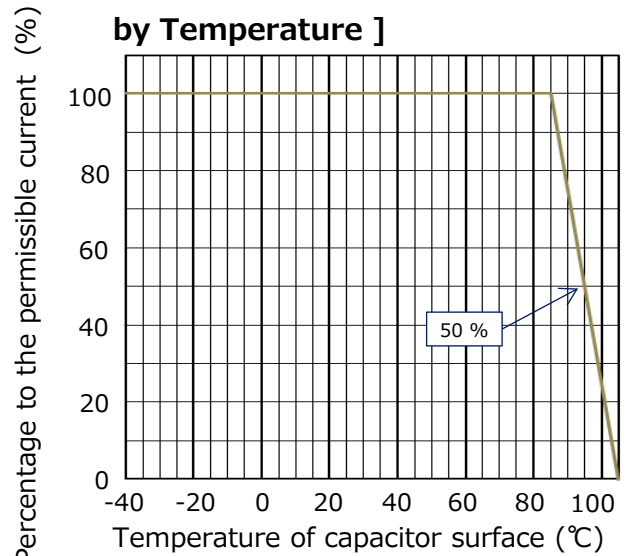

[Voltage Derating by Temperature]

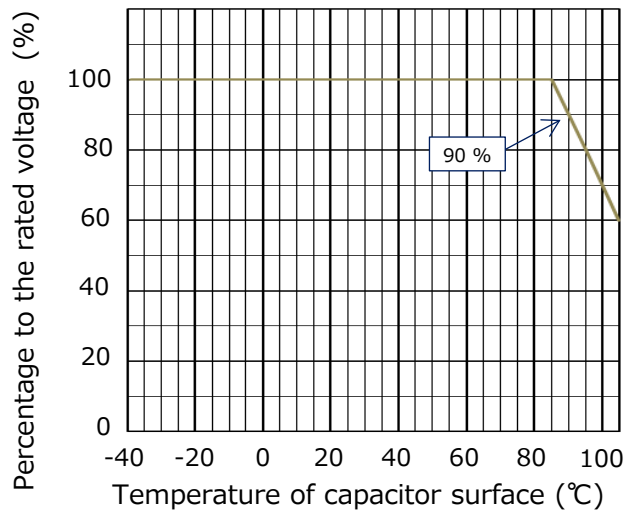

[Self Heating Derating by Temperature]

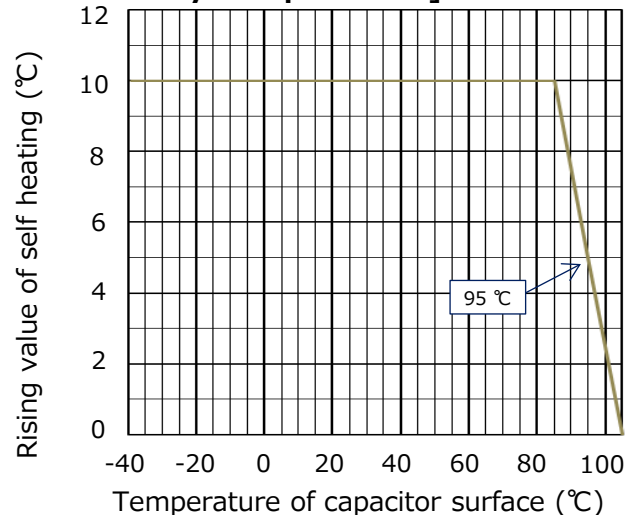

Characteristics data

■ Rated voltage [AC] : 600 V (Lead pitch 52.5 mm)

Electrical characteristics <Typical data >

Temperature characteristics

at 1 kHz [Capacitance change]

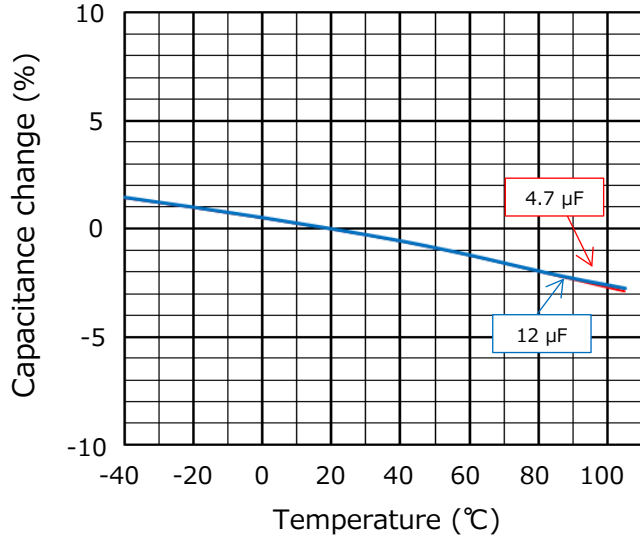

Frequency characteristics

[Impedance characteristics]

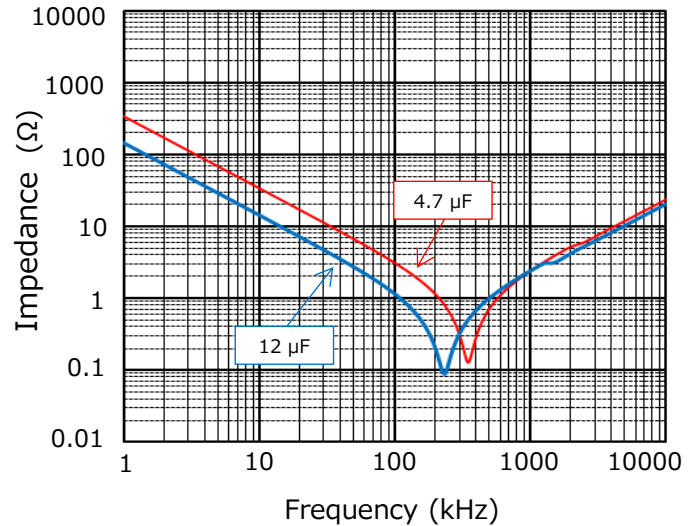

at 1 kHz [Dissipation factor]

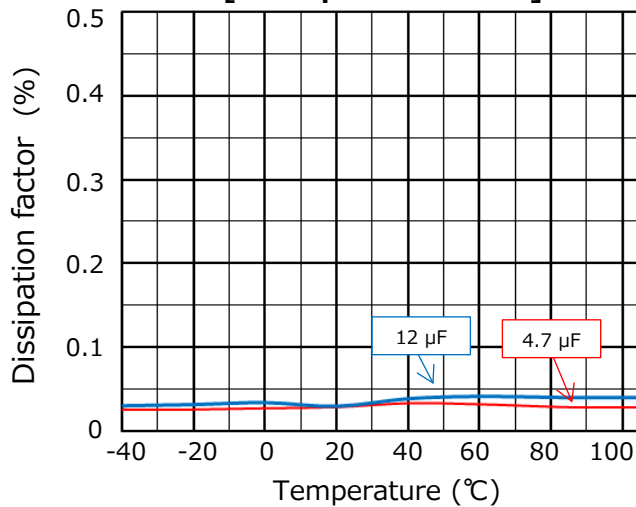

at DC 100 V [Insulation resistance]

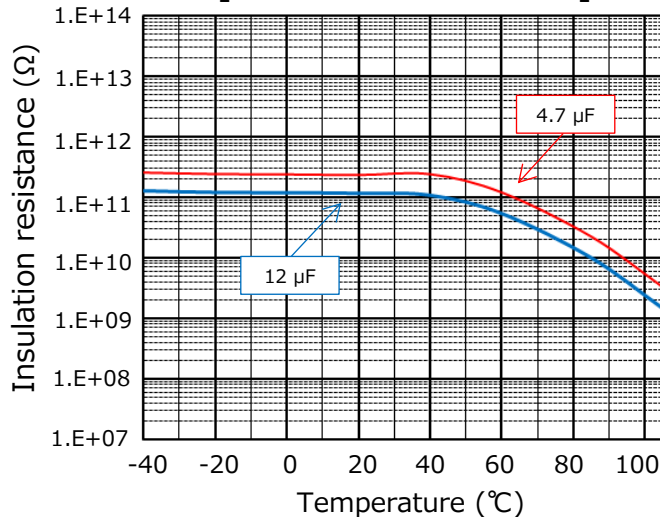

Characteristics data

■ **Rated voltage [AC] : 600 V (Lead pitch 52.5 mm)**

Applicable specifications

[Permissible Current]

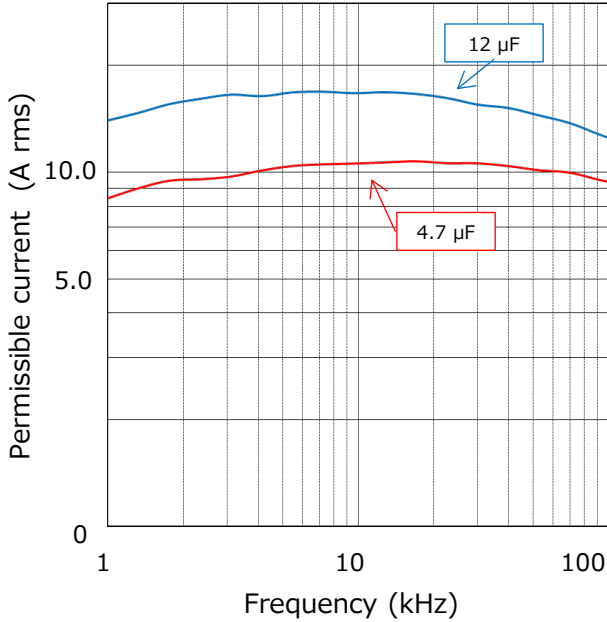

[Lifetime expectancy]

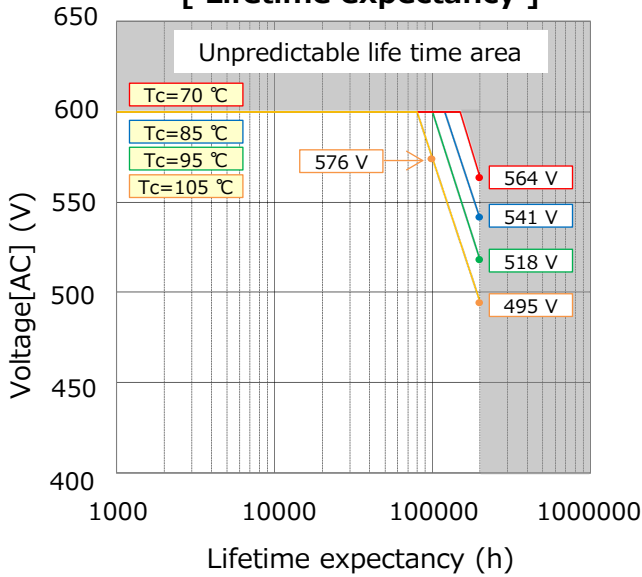

**Permissible pulse current (dV/dt)
(Max. 10000 cycles)**

R. voltage [AC] (V)	Pitch (mm)	Capacitance (µF)	Code	dV/dt (V/µs)	Current (Ao-p)
600	52.5	4.7	475	70	329.0
		6.8	685		476.0
		7.0	705		490.0
		10.0	106		700.0
		12.0	126		840.0

[Permissible Current Derating by Temperature]

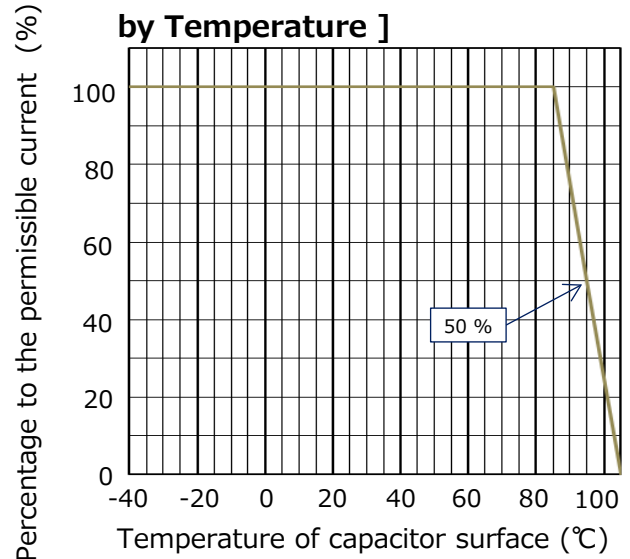

[Voltage Derating by Temperature]

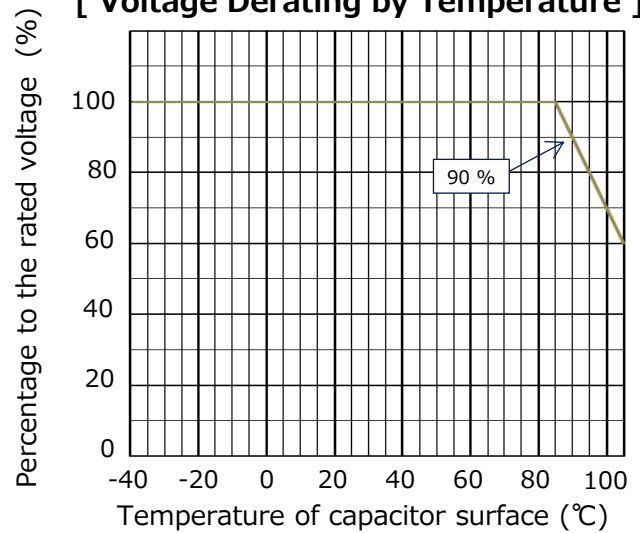

[Self Heating Derating by Temperature]

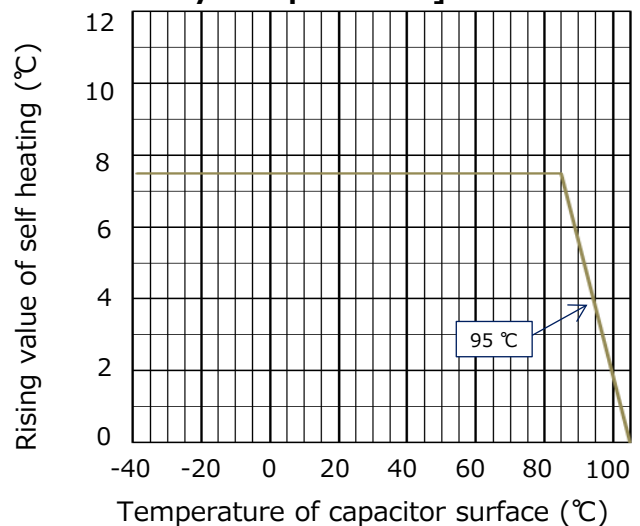

Guidelines and precautions regarding the technical information and use of our products described in this online catalog.

- If you want to use our products described in this online catalog for applications requiring special qualities or reliability, or for applications where the failure or malfunction of the products may directly jeopardize human life or potentially cause personal injury (e.g. aircraft and aerospace equipment, traffic and transportation equipment, combustion equipment, medical equipment, accident prevention, anti-crime equipment, and/or safety equipment), it is necessary to verify whether the specifications of our products fit to such applications. Please ensure that you will ask and check with our inquiry desk as to whether the specifications of our products fit to such applications use before you use our products.
- The quality and performance of our products as described in this online catalog only apply to our products when used in isolation. Therefore, please ensure you evaluate and verify our products under the specific circumstances in which our products are assembled in your own products and in which our products will actually be used.
- If you use our products in equipment that requires a high degree of reliability, regardless of the application, it is recommended that you set up protection circuits and redundancy circuits in order to ensure safety of your equipment.
- The products and product specifications described in this online catalog are subject to change for improvement without prior notice. Therefore, please be sure to request and confirm the latest product specifications which explain the specifications of our products in detail, before you finalize the design of your applications, purchase, or use our products.
- The technical information in this online catalog provides examples of our products' typical operations and application circuits. We do not guarantee the non-infringement of third party's intellectual property rights and we do not grant any license, right, or interest in our intellectual property.
- If any of our products, product specifications and/or technical information in this online catalog is to be exported or provided to non-residents, the laws and regulations of the exporting country, especially with regard to security and export control, shall be observed.

<Regarding the Certificate of Compliance with the EU RoHS Directive/REACH Regulations>

- The switchover date for compliance with the RoHS Directive/REACH Regulations varies depending on the part number or series of our products.
- When you use the inventory of our products for which it is unclear whether those products are compliant with the RoHS Directive/REACH Regulation, please select "Sales Inquiry" in the website inquiry form and contact us.

We do not take any responsibility for the use of our products outside the scope of the specifications, descriptions, guidelines and precautions described in this online catalog.

PRECAUTION AND WARNING

- Please consult us in case that demand the specification of our company without fail and do the confirmation of the use condition and that exceeds the entry value and be indistinct when you use it.
- The film capacitors contain a film based dielectric which may be flammable under certain operating conditions. When in use, they can either emit smoke and/or ignite should the product be defective. It is recommended covering the surrounding resin with flame-resistant materials or case as needed particularly.
- In the event of troubles of other parts on the circuit such as shortening and opening, provide with proper means for preventing excessive voltage, current or temperature exceeding the rating from being applied to the film capacitor.
- Prior to use, please make sure that failure of the film capacitors does not have any negative effects on other surrounding electronic circuit components and devices that would possibly cause damage. Proper safety measures should be taken using fail-safe protective circuit designs to help prevent other devices of becoming unsafe.
 - Example:
 - a. State in which basic performance of automobiles (run, turn and stop)
 - b. False operations
 - c. Smoke emission/ignitions
- The Film Capacitor listed in this catalog(except for automotive series) are designed and manufactured specifically for general electronic devices, including audio-video equipment, home appliance, office equipment and data communication equipment etc.. Accordingly, it is strongly recommended that the user contact us in advance if the parts are to be used for the following devices(items 1 -12), which require having advanced security measures. The capacitor for automotive can be used for automobiles such as xEV.
 - (1) Transport Equipment (motor vehicles, airplanes, trains, ships, traffic signal controllers)
 - (2) Medical Equipment (life-support equipment, pacemakers for the heart, dialysis controllers)
 - (3) Aircraft Equipment, Aerospace Equipment (airplanes, artificial satellites, rockets, etc.)
 - (4) Submarine Equipment (submarine repeating equipment, etc.)
 - (5) Generation Control Equipment (equipment for atomic/hydraulic/heat power plants)
 - (6) Information Processing Equipment (large scale computer system)
 - (7) Electric Heating Appliance, Burning Apparatus
 - (8) Rotary Motion Equipment
 - (9) Security Systems
 - (10) Robots
 - (11) Lighting Equipment
 - (12) And any similar types of equipment
- If used in a specific appliance that requires an extremely high reliability directly relating with any life-supporting equipment like electronic aviation controllers, automotive driving controllers and engine controllers, please consult us and use within the conditions designated in the specification. However the chip type capacitor should not be used in these appliances.

Note:

1. Technical information in this catalog is intended to convey examples of typical performances and/or applications, and is not intended to convey patents rights, if any.
2. For the products, which are controlled items subject to the Foreign Exchange and Foreign Trade Control Law, the export permission according to the Law is necessary.
3. Note of ozone depleting substances of class1 (ODS) under the Montreal Protocol is used in manufacturing process of Device Solutions Business Division, Panasonic Corporation.

■ AEC-Q200 compliant

The products are tested based on all or part of the test conditions and methods defined in AEC-Q200. Please consult with Panasonic for the details of the product specification and specific evaluation test results, etc., and please review and approve Panasonic's product specification before ordering.

* Intellectual property right

We, Panasonic Group are providing the product and service that customers can use without anxiety, working positively on the protection of our products under intellectual property rights.

Representative patents relating to xEV Film capacitors are as follows :

US Paten No.7027286, No.8315031, No.8861177, No.9240279, No.10475585
JP Patent No.4784464, No.4930099, No.4946618, No.5391797