

KRTBDWLM32.32

OSIRE® E3323

The OSIRE E3323 is designed for automotive ambient applications. With its compact size, the device offers a maximum of flexibility for various assembly situations.

All measurement data of every single LED is made available at 10 and 50 mA via an imprinted data matrix code. This feature helps to reduce the optical measurement effort on customer side.



Applications

- Interior Illumination (e.g. Ambient Map)

Features:

- Package: white SMD package, colorless clear silicone resin
- Chip technology: Thinfilm / ThinGaN
- Color: $\lambda_{\text{dom}} = 626.0 \text{ nm}$ (● red); $\lambda_{\text{dom}} = 533.0 \text{ nm}$ (● true green); $\lambda_{\text{dom}} = 462.0 \text{ nm}$ (● blue)
- Corrosion Robustness Class: 2B
- Qualifications: AEC-Q102 Qualified
- ESD: 2 kV acc. to ANSI/ESDA/JEDEC JS-001 (HBM, Class 2)
- Measurement data available via DMC
- Size of DMC: 1.6 x 0.4 mm
- Pixel size: 50 μm
- Access to look-up file provided by OS
- Data format: .csv
- Device ID linked to electro-optical test data
- White point calibration based on test data possible
- Test Data available at two setpoints (10 and 50 mA)

Ordering Information

| Type | Brightness IF = 10 mA | Ordering code |
|---------------------------------------|--------------------------|---------------|
| KRTBDWLM32.32-T4U6-JW+AAAB-J3+R4S6-5V | | Q65112A7940 |
| red | IV = 315 ... 800 mcd | |
| true green | IV = 1120 ... 1800 mcd | |
| blue | IV = 125 ... 320 mcd | |

Typical brightness

$T_S = 25\text{ °C}$

| Color | Current in mA | Value | Unit |
|------------|------------------|-------|------|
| red | 10 | 560 | mcd |
| true green | 10 | 1460 | mcd |
| blue | 10 | 220 | mcd |
| red | 50 | 2700 | mcd |
| true green | 50 | 4140 | mcd |
| blue | 50 | 720 | mcd |

Maximum Ratings

| Parameter | Symbol | | Values | Values | Values |
|---|-----------|------|--------|--------------|--------|
| | | | ● red | ● true green | ● blue |
| Operating Temperature | T_{op} | min. | -40 °C | -40 °C | -40 °C |
| | | max. | 110 °C | 110 °C | 110 °C |
| Storage Temperature | T_{stg} | min. | -40 °C | -40 °C | -40 °C |
| | | max. | 110 °C | 110 °C | 110 °C |
| Junction Temperature | T_j | max. | 125 °C | 125 °C | 125 °C |
| Forward Current $T_s = 25\text{ °C}$ | I_F | min. | 1 mA | 1 mA | 1 mA |
| | | max. | 50 mA | 50 mA | 50 mA |
| Reverse voltage ¹⁾ $T_s = 25\text{ °C}$ | V_R | max. | 12 V | 5 V | 5 V |
| ESD withstand voltage acc. to ANSI/ESDA/JEDEC JS-001 (HBM, Class 2) | V_{ESD} | | 2 kV | 2 kV | 2 kV |

Characteristics

$I_F = 10 \text{ mA}$; $T_S = 25 \text{ °C}$

| Parameter | Symbol | | Values | Values | Values |
|--|-------------------------|------|--------------------|--------------------|--------------------|
| | | | ● red | ● true green | ● blue |
| Peak Wavelength | λ_{peak} | typ. | 635.0 nm | 526.0 nm | 456.0 nm |
| Dominant Wavelength ²⁾ | λ_{dom} | min. | 620.0 nm | 524.0 nm | 449.0 nm |
| | | typ. | 626.0 nm | 533.0 nm | 462.0 nm |
| | | max. | 632.0 nm | 541.0 nm | 473.0 nm |
| Forward Voltage ³⁾ | V_F | typ. | 1.90 V | 2.45 V | 2.75 V |
| Reverse current ¹⁾ VR = 5 V (blue / true green); 12 V (red) | I_R | typ. | 0.01 μA | 0.01 μA | 0.01 μA |
| | | max. | 10 μA | 10 μA | 10 μA |
| Real thermal resistance junction/sol- derpoint ⁴⁾ | $R_{\text{thJS real}}$ | typ. | 83 K / W | 61 K / W | 59 K / W |
| | | max. | 100 K / W | 74 K / W | 83 K / W |

Brightness Groups

- red

| Group | Luminous Intensity ⁵⁾ $I_F = 10 \text{ mA}$ min. I_v | Luminous Intensity ⁵⁾ $I_F = 10 \text{ mA}$ max. I_v |
|-------|--|--|
| T4 | 315 mcd | 400 mcd |
| T2 | 355 mcd | 450 mcd |
| T6 | 400 mcd | 500 mcd |
| U1 | 450 mcd | 560 mcd |
| U4 | 500 mcd | 630 mcd |
| U2 | 560 mcd | 710 mcd |
| U6 | 630 mcd | 800 mcd |

Brightness Groups

- true green

| Group | Luminous Intensity ²⁾ $I_F = 10 \text{ mA}$ min. I_v | Luminous Intensity ⁵⁾ $I_F = 10 \text{ mA}$ max. I_v |
|-------|--|--|
| AA | 1120 mcd | 1400 mcd |
| A4 | 1250 mcd | 1590 mcd |
| AB | 1400 mcd | 1800 mcd |

Brightness Groups

- blue

| Group | Luminous Intensity ⁵⁾ $I_F = 10 \text{ mA}$ min. I_v | Luminous Intensity ⁵⁾ $I_F = 10 \text{ mA}$ max. I_v |
|-------|--|--|
| R4 | 125 mcd | 159 mcd |
| R2 | 140 mcd | 180 mcd |
| R6 | 159 mcd | 201 mcd |
| S1 | 180 mcd | 224 mcd |
| S4 | 201 mcd | 250 mcd |
| S2 | 224 mcd | 280 mcd |
| S6 | 250 mcd | 320 mcd |

Wavelength Groups

- red

| Group | Dominant Wavelength ²⁾ min. | Dominant Wavelength ²⁾ max. |
|-------|---|---|
| | λ_{dom} | λ_{dom} |
| JP | 620.0 nm | 625.0 nm |
| MT | 623.0 nm | 629.0 nm |
| RW | 627.0 nm | 632.0 nm |

Wavelength Groups

- true green

| Group | Dominant Wavelength ²⁾ min. | Dominant Wavelength ²⁾ max. |
|-------|---|---|
| | λ_{dom} | λ_{dom} |
| JP | 524.0 nm | 529.0 nm |
| LR | 526.0 nm | 531.0 nm |
| PU | 529.0 nm | 534.0 nm |
| RW | 531.0 nm | 536.0 nm |
| U3 | 534.0 nm | 541.0 nm |

Wavelength Groups

- blue

| Group | Dominant Wavelength ²⁾ min. | Dominant Wavelength ²⁾ max. |
|-------|---|---|
| | λ_{dom} | λ_{dom} |
| 51 | 449.0 nm | 453.0 nm |
| 3C | 451.0 nm | 456.0 nm |
| AF | 454.0 nm | 459.0 nm |
| DH | 457.0 nm | 461.0 nm |
| FK | 459.0 nm | 463.0 nm |
| HM | 461.0 nm | 465.0 nm |
| KP | 463.0 nm | 467.0 nm |
| MS | 465.0 nm | 470.0 nm |
| QV | 468.0 nm | 473.0 nm |

Chromaticity Coordinate Groups

● red

| Group | Cx | Cy |
|-------|--------|--------|
| JP | 0.6879 | 0.3086 |
| | 0.6915 | 0.3083 |
| | 0.7006 | 0.2993 |
| | 0.6969 | 0.2996 |
| MT | 0.6936 | 0.3030 |
| | 0.6972 | 0.3027 |
| | 0.7066 | 0.2934 |
| | 0.7028 | 0.2938 |
| RW | 0.7000 | 0.2966 |
| | 0.7037 | 0.2962 |
| | 0.7105 | 0.2895 |
| | 0.7067 | 0.2899 |

Chromaticity Coordinate Groups

● true green

| Group | Cx | Cy |
|-------|--------|--------|
| JP | 0.1606 | 0.7102 |
| | 0.1415 | 0.7518 |
| | 0.1679 | 0.7565 |
| | 0.1831 | 0.7174 |
| LR | 0.1694 | 0.7136 |
| | 0.1517 | 0.7547 |
| | 0.1794 | 0.7549 |
| | 0.1933 | 0.7170 |
| PU | 0.1831 | 0.7174 |
| | 0.1678 | 0.7565 |
| | 0.1973 | 0.7500 |
| | 0.2091 | 0.7142 |
| RW | 0.1932 | 0.7170 |
| | 0.1794 | 0.7549 |
| | 0.2098 | 0.7449 |
| | 0.2196 | 0.7122 |

Chromaticity Coordinate Groups

- true green

| Group | Cx | Cy |
|-------|--------|--------|
| U3 | 0.2091 | 0.7142 |
| | 0.1974 | 0.7500 |
| | 0.2419 | 0.7273 |
| | 0.2474 | 0.7029 |

Chromaticity Coordinate Groups

- blue

| Group | Cx | Cy |
|-------|--------|--------|
| 3C | 0.1588 | 0.0243 |
| | 0.1556 | 0.0186 |
| | 0.1500 | 0.0246 |
| | 0.1543 | 0.0317 |
| 51 | 0.1606 | 0.0222 |
| | 0.1576 | 0.0168 |
| | 0.1534 | 0.0206 |
| | 0.1570 | 0.0268 |
| AF | 0.1562 | 0.0285 |
| | 0.1524 | 0.0219 |
| | 0.1462 | 0.0293 |
| | 0.1509 | 0.0370 |
| DH | 0.1532 | 0.0332 |
| | 0.1489 | 0.0262 |
| | 0.1436 | 0.0332 |
| | 0.1487 | 0.0414 |
| FK | 0.1509 | 0.0370 |
| | 0.1462 | 0.0293 |
| | 0.1407 | 0.0376 |
| | 0.1463 | 0.0463 |
| HM | 0.1487 | 0.0414 |
| | 0.1436 | 0.0332 |
| | 0.1375 | 0.0428 |
| | 0.1436 | 0.0519 |

Chromaticity Coordinate Groups

- blue

| Group | Cx | Cy |
|-------|--------|--------|
| KP | 0.1463 | 0.0463 |
| | 0.1407 | 0.0376 |
| | 0.1338 | 0.0493 |
| | 0.1404 | 0.0588 |
| MS | 0.1436 | 0.0519 |
| | 0.1375 | 0.0428 |
| | 0.1272 | 0.0620 |
| | 0.1354 | 0.0727 |
| QV | 0.1389 | 0.0631 |
| | 0.1317 | 0.0532 |
| | 0.1199 | 0.0785 |
| | 0.1295 | 0.0899 |

Relative Spectral Emission ⁶⁾

$I_{rel} = f(\lambda); I_F = 10 \text{ mA}; T_S = 25 \text{ }^\circ\text{C}$

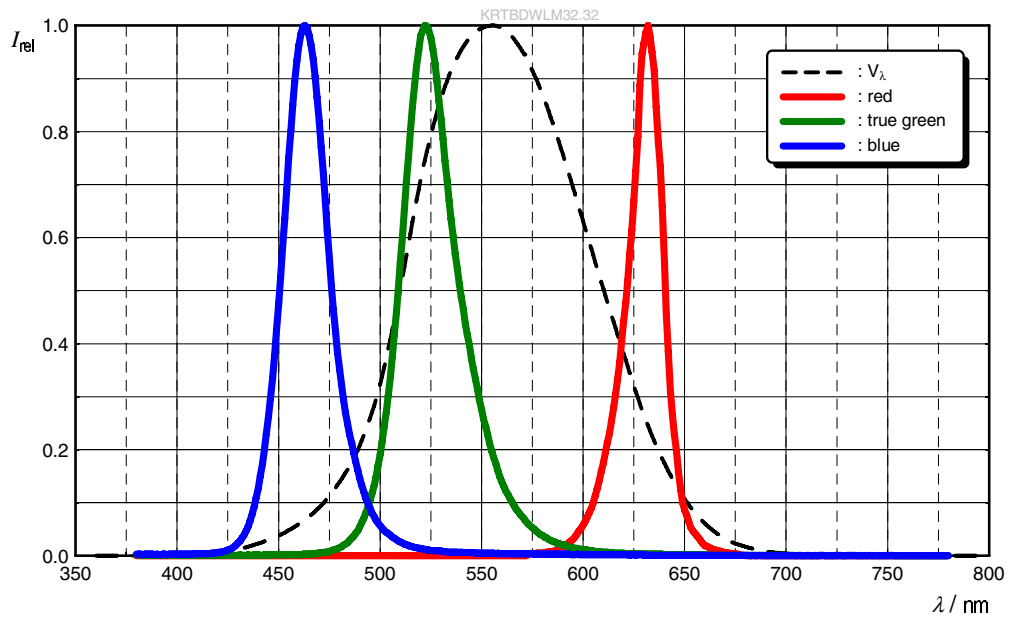

Radiation Characteristics ⁶⁾

$I_{rel} = f(\phi); T_S = 25 \text{ }^\circ\text{C}$

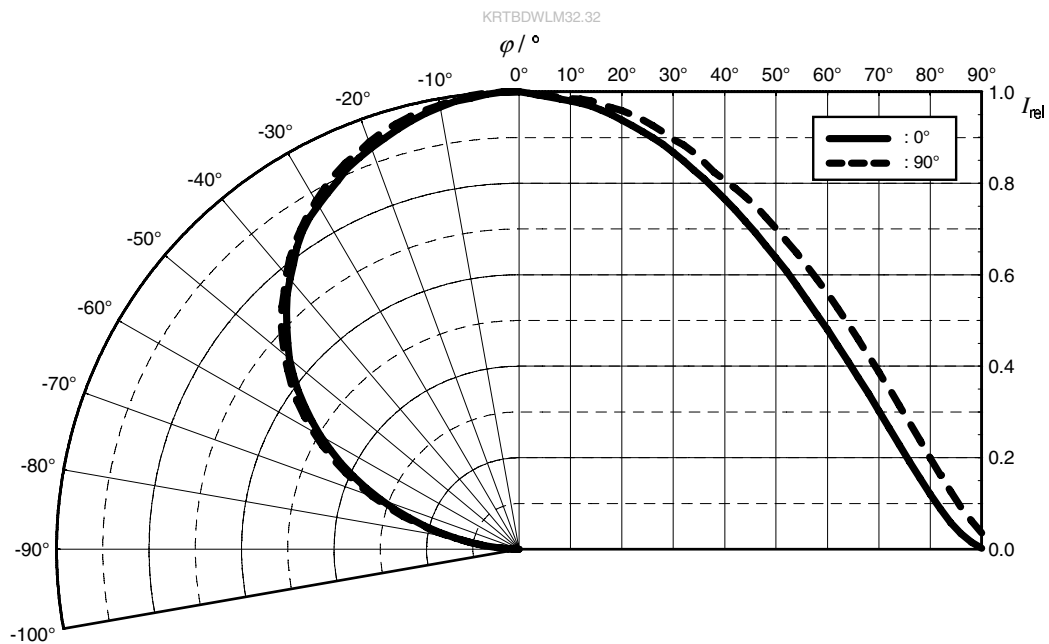

Forward current ⁶⁾

$I_F = f(V_F); T_S = 25\text{ °C}$

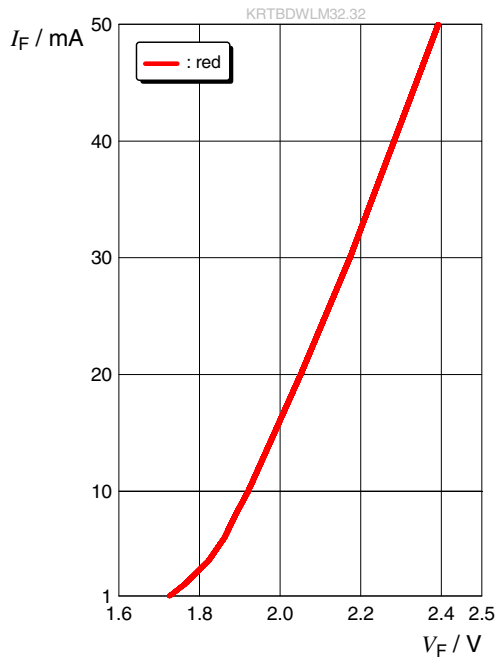

Forward current ⁶⁾

$I_F = f(V_F); T_S = 25\text{ °C}$

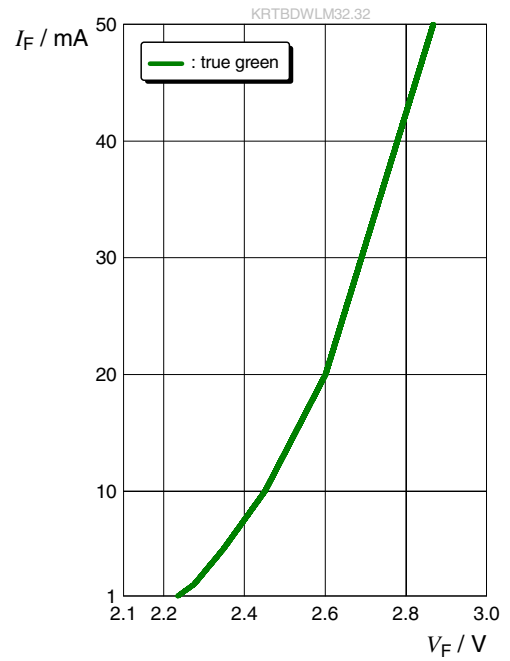

Forward current ⁶⁾

$I_F = f(V_F); T_S = 25\text{ °C}$

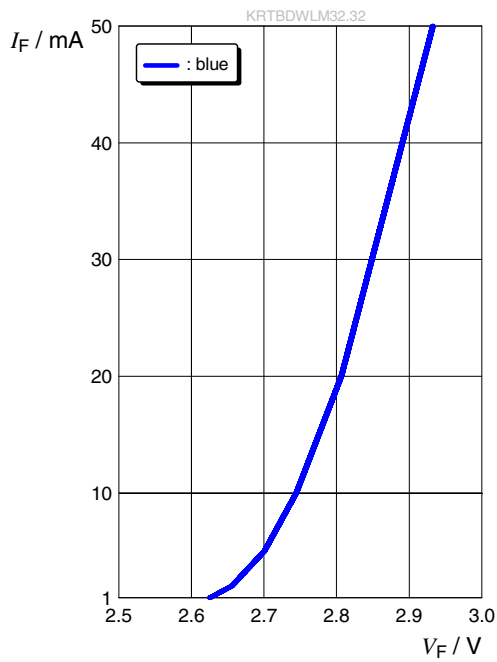

Relative Luminous Intensity 6), 7)

$I_V/I_V(10\text{ mA}) = f(I_F); T_S = 25\text{ }^\circ\text{C}$

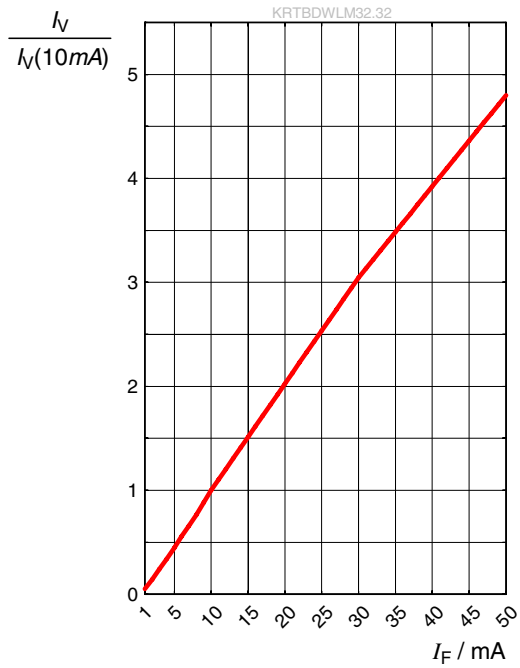

Relative Luminous Intensity 6), 7)

$I_V/I_V(10\text{ mA}) = f(I_F); T_S = 25\text{ }^\circ\text{C}$

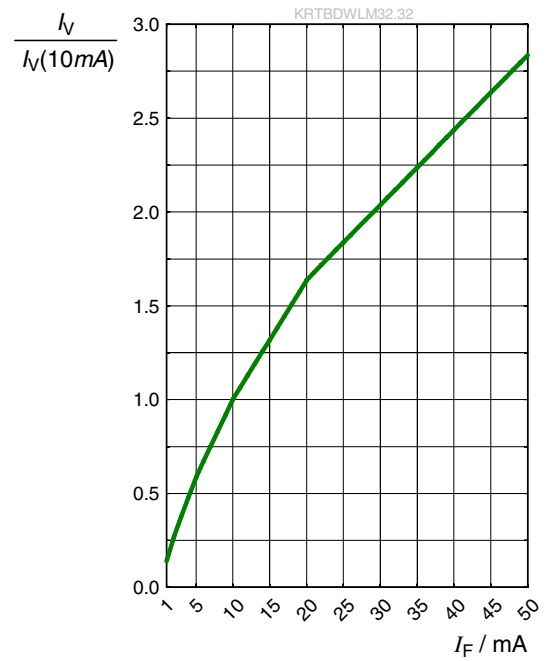

Relative Luminous Intensity 6), 7)

$I_V/I_V(10\text{ mA}) = f(I_F); T_S = 25\text{ }^\circ\text{C}$

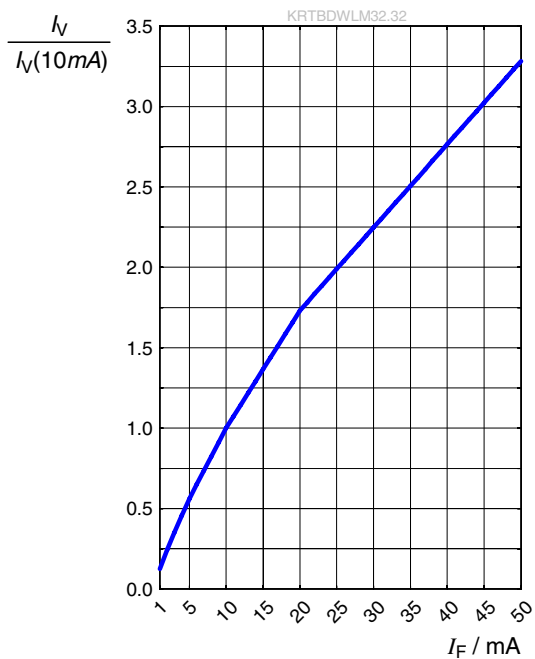

Dominant Wavelength ⁶⁾

$$\Delta\lambda_{\text{dom}} = f(I_F); T_S = 25\text{ }^\circ\text{C}$$

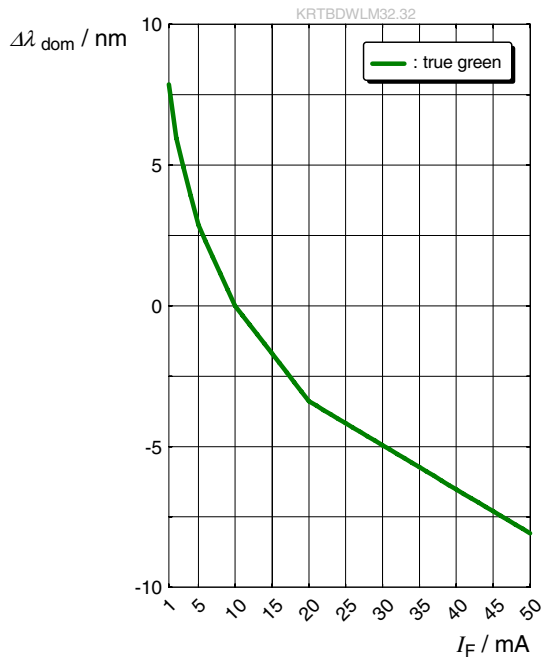

Dominant Wavelength ⁶⁾

$$\Delta\lambda_{\text{dom}} = f(I_F); T_S = 25\text{ }^\circ\text{C}$$

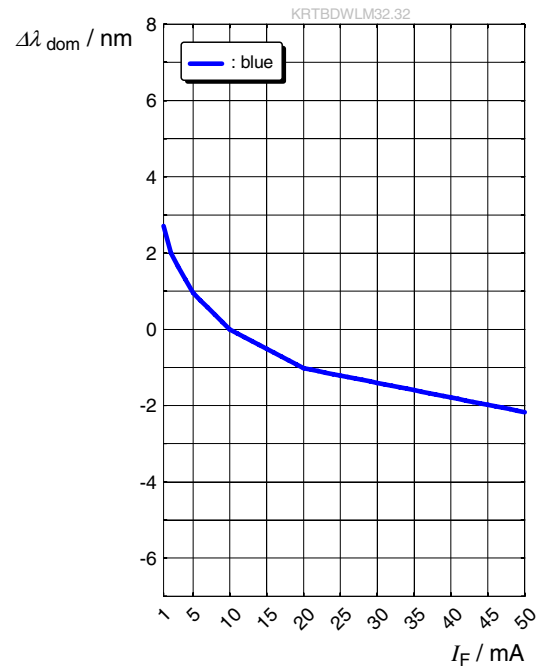

Forward Voltage ⁶⁾

$$\Delta V_F = V_F - V_F(25\text{ }^\circ\text{C}) = f(T_j); I_F = 10\text{ mA}$$

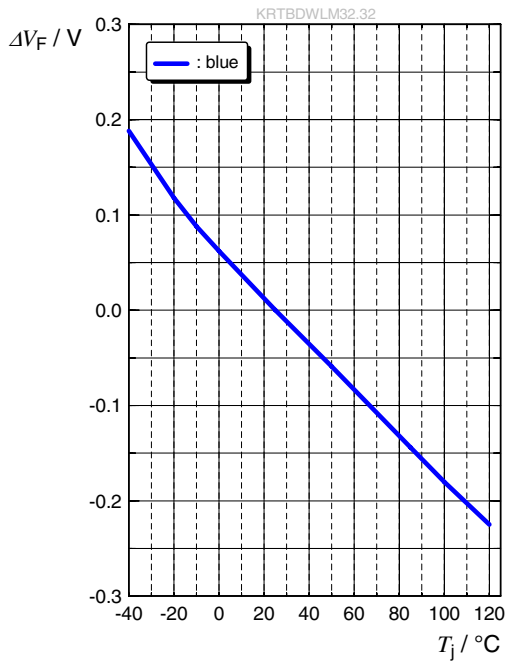

Forward Voltage ⁶⁾

$$\Delta V_F = V_F - V_F(25\text{ }^\circ\text{C}) = f(T_j); I_F = 10\text{ mA}$$

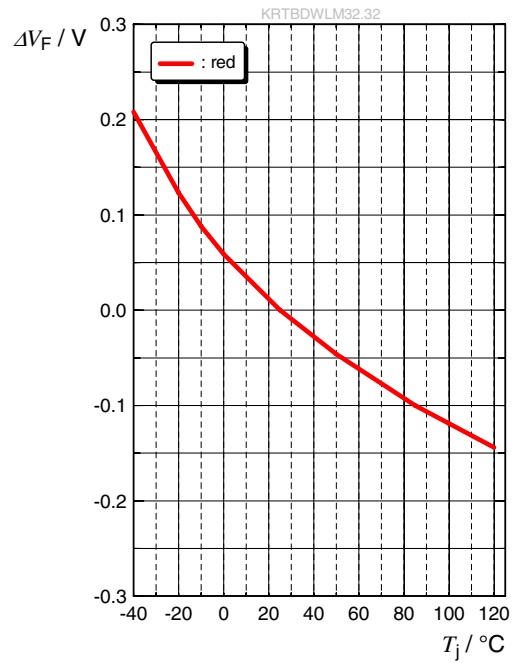

Forward Voltage ⁶⁾

$$\Delta V_F = V_F - V_F(25\text{ }^\circ\text{C}) = f(T_j); I_F = 10\text{ mA}$$

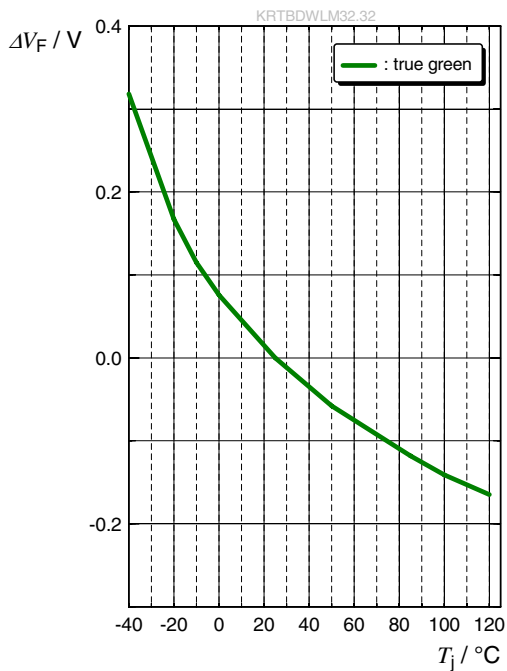

Relative Luminous Intensity ⁶⁾

$I_V/I_V(25\text{ °C}) = f(T_j); I_F = 10\text{ mA}$

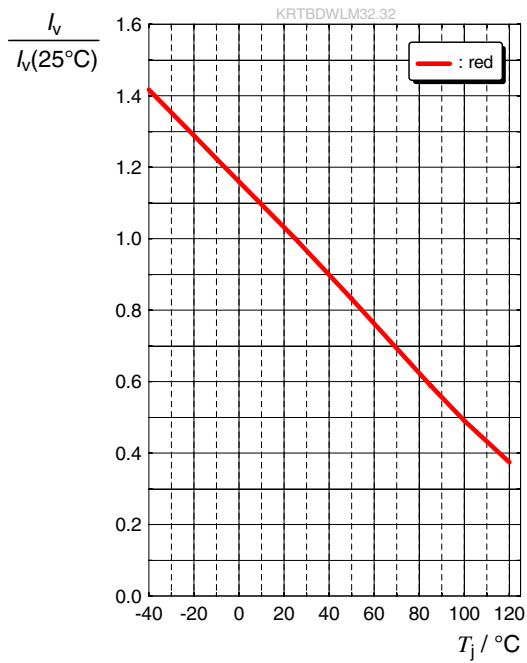

Relative Luminous Intensity ⁶⁾

$I_V/I_V(25\text{ °C}) = f(T_j); I_F = 10\text{ mA}$

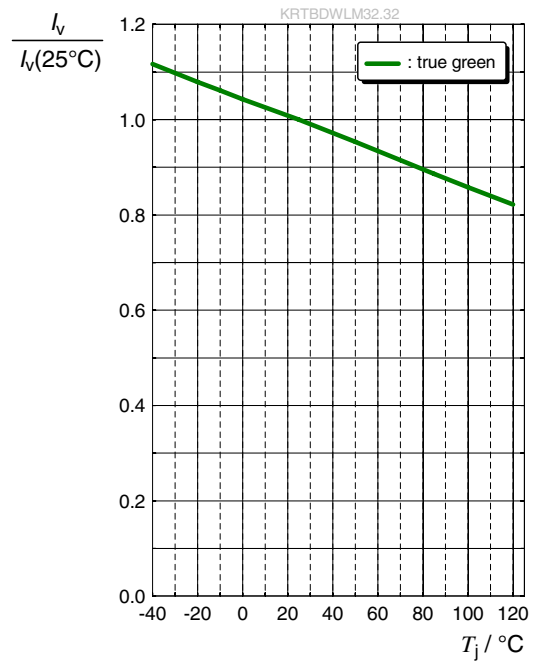

Relative Luminous Intensity ⁶⁾

$I_V/I_V(25\text{ °C}) = f(T_j); I_F = 10\text{ mA}$

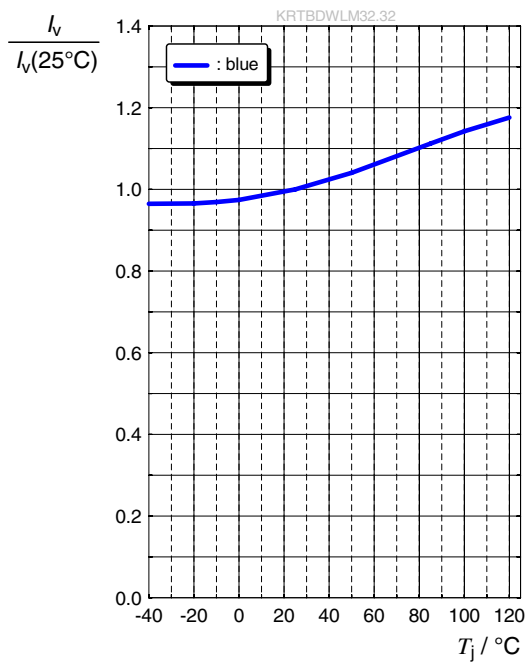

Dominant Wavelength ⁶⁾

$$\Delta\lambda_{\text{dom}} = \lambda_{\text{dom}} - \lambda_{\text{dom}}(25\text{ °C}) = f(T_j); I_F = 10\text{ mA}$$

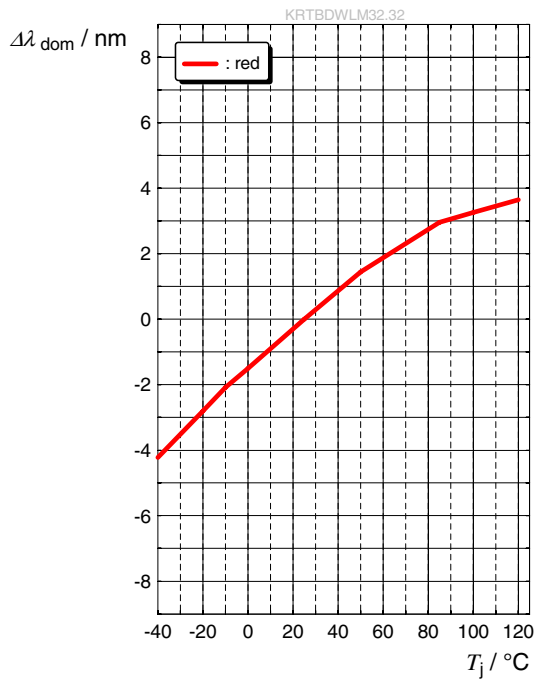

Dominant Wavelength ⁶⁾

$$\Delta\lambda_{\text{dom}} = \lambda_{\text{dom}} - \lambda_{\text{dom}}(25\text{ °C}) = f(T_j); I_F = 10\text{ mA}$$

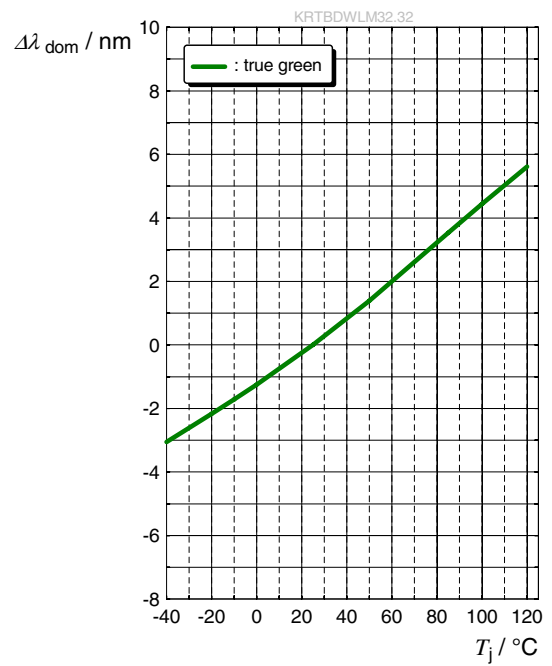

Dominant Wavelength ⁶⁾

$$\Delta\lambda_{\text{dom}} = \lambda_{\text{dom}} - \lambda_{\text{dom}}(25\text{ °C}) = f(T_j); I_F = 10\text{ mA}$$

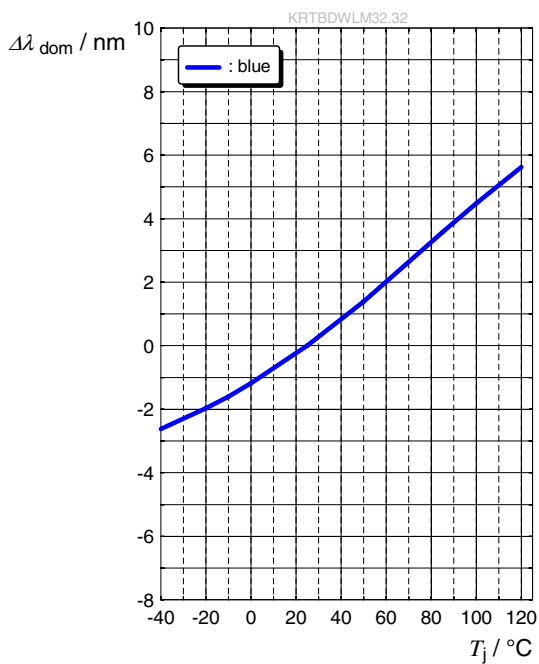

Max. Permissible Forward Current

$I_F = f(T)$; ● red

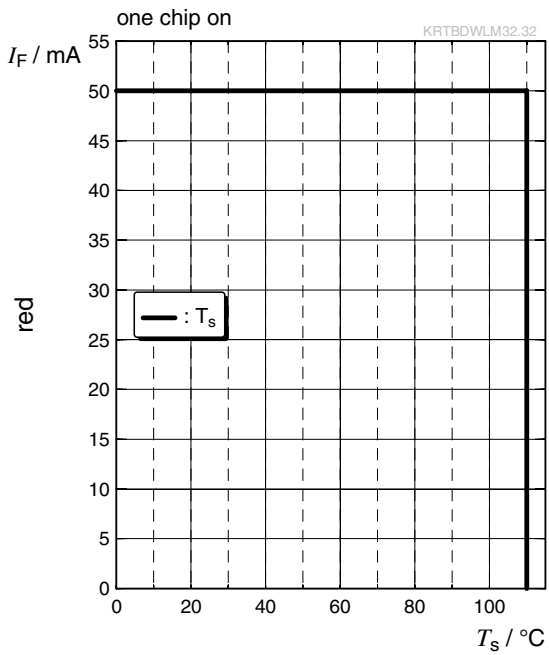

Max. Permissible Forward Current

$I_F = f(T)$; ● true green

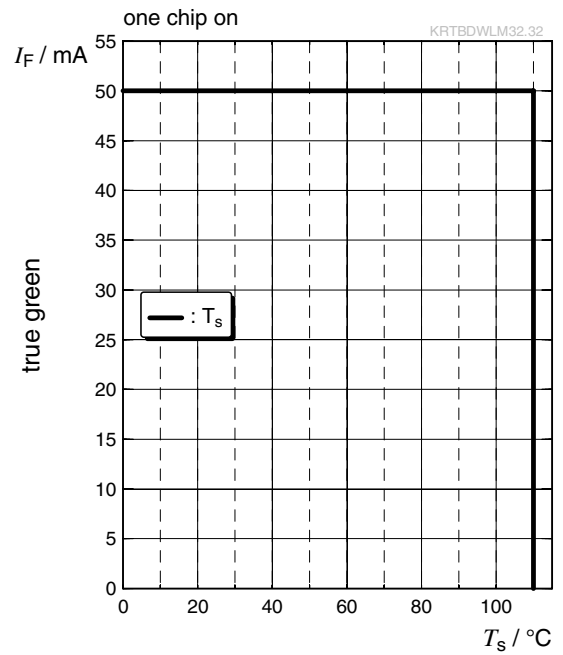

Max. Permissible Forward Current

$I_F = f(T)$; ● blue

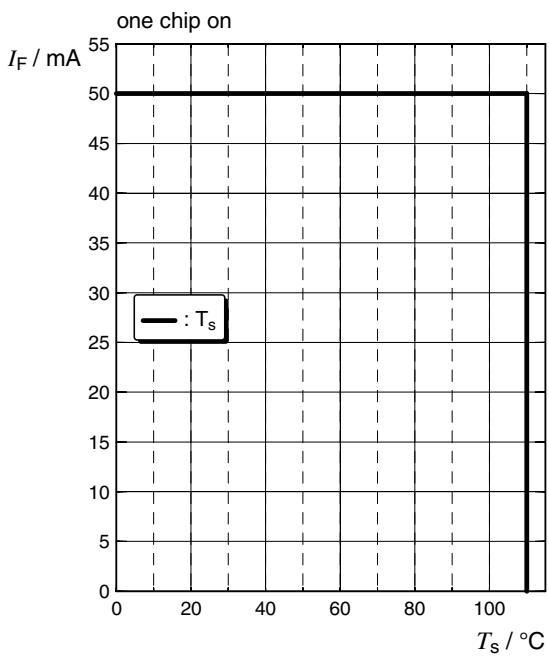

Electrical Internal Circuit

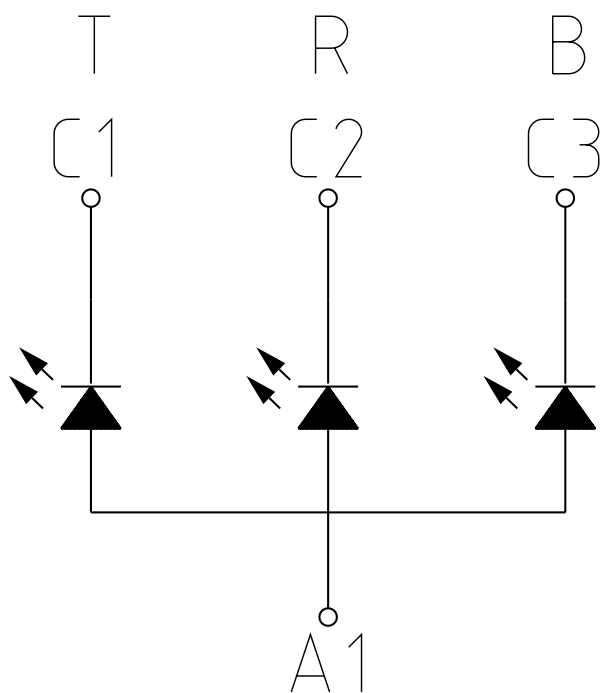

Recommended Solder Pad ⁸⁾

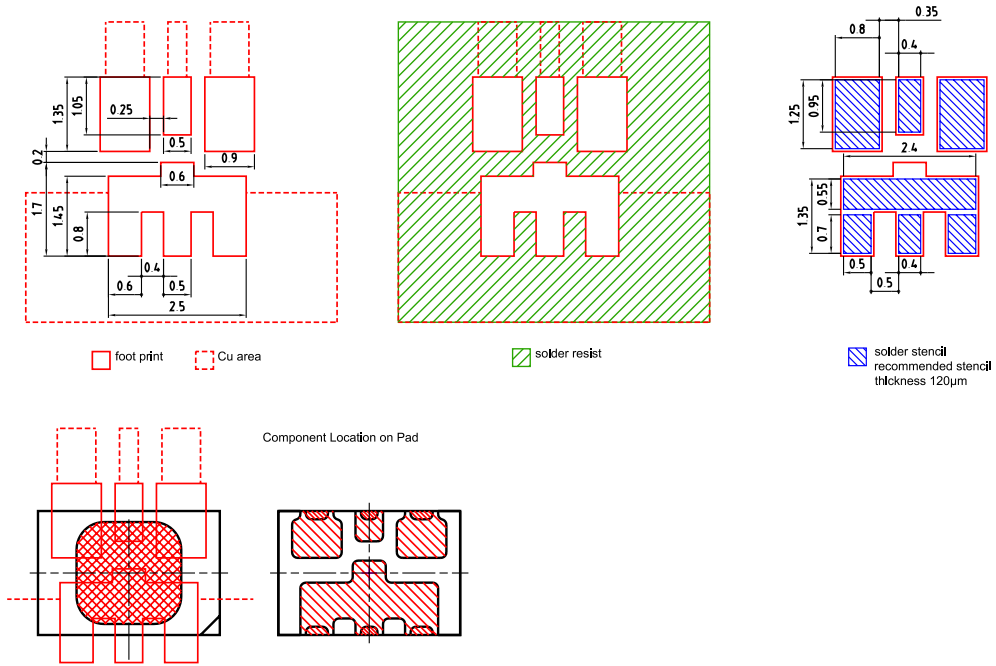

E062 3010.245 -02

For superior solder joint connectivity results we recommend soldering under standard nitrogen atmosphere. Package not suitable for any kind of wet cleaning or ultrasonic cleaning.

Reflow Soldering Profile

Product complies to MSL Level 2 acc. to JEDEC J-STD-020E

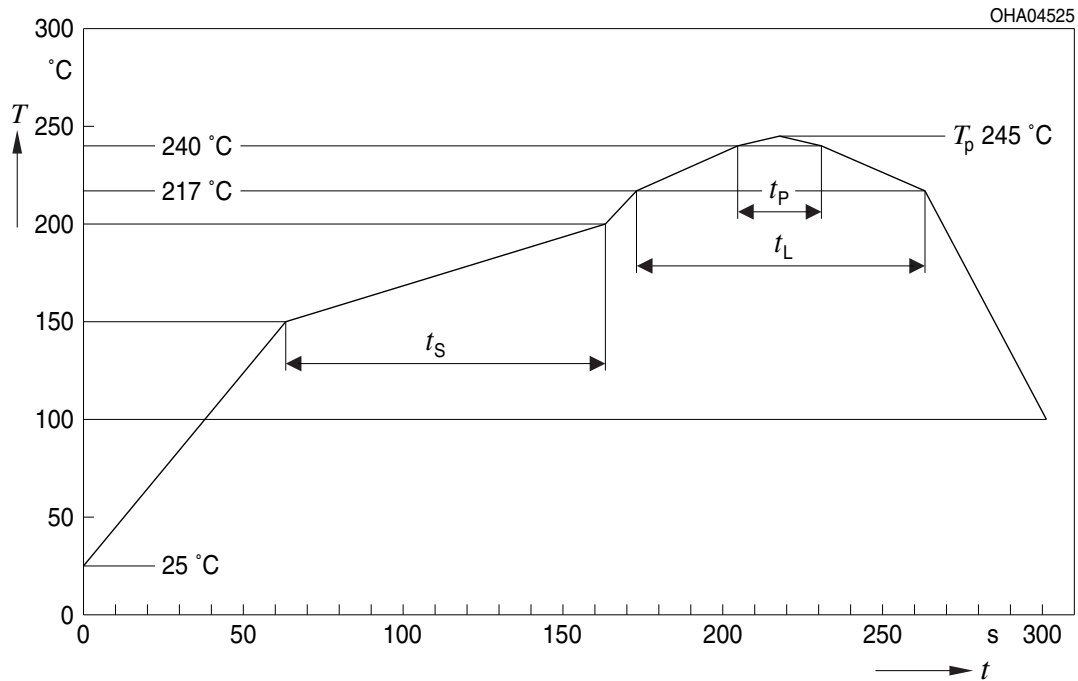

| Profile Feature | Symbol | Pb-Free (SnAgCu) Assembly | | | Unit |
|---|--------|---------------------------|----------------|---------|------|
| | | Minimum | Recommendation | Maximum | |
| Ramp-up rate to preheat ^{*)} 25 °C to 150 °C | | | 2 | 3 | K/s |
| Time t_s T_{Smin} to T_{Smax} | t_s | 60 | 100 | 120 | s |
| Ramp-up rate to peak ^{*)} T_{Smax} to T_p | | | 2 | 3 | K/s |
| Liquidus temperature | T_L | | 217 | | °C |
| Time above liquidus temperature | t_L | | 80 | 100 | s |
| Peak temperature | T_p | | 245 | 260 | °C |
| Time within 5 °C of the specified peak temperature $T_p - 5$ K | t_p | 10 | 20 | 30 | s |
| Ramp-down rate* T_p to 100 °C | | | 3 | 6 | K/s |
| Time 25 °C to T_p | | | | 480 | s |

All temperatures refer to the center of the package, measured on the top of the component

* slope calculation DT/Dt : Dt max. 5 s; fulfillment for the whole T-range

Taping ⁸⁾

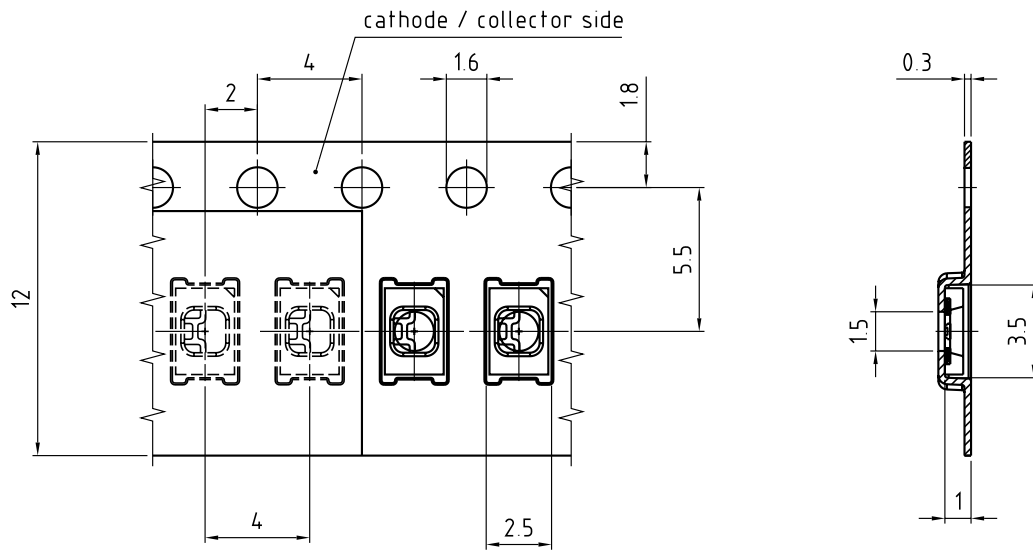

C67062-A0273-B5-01

Tape and Reel ⁹⁾

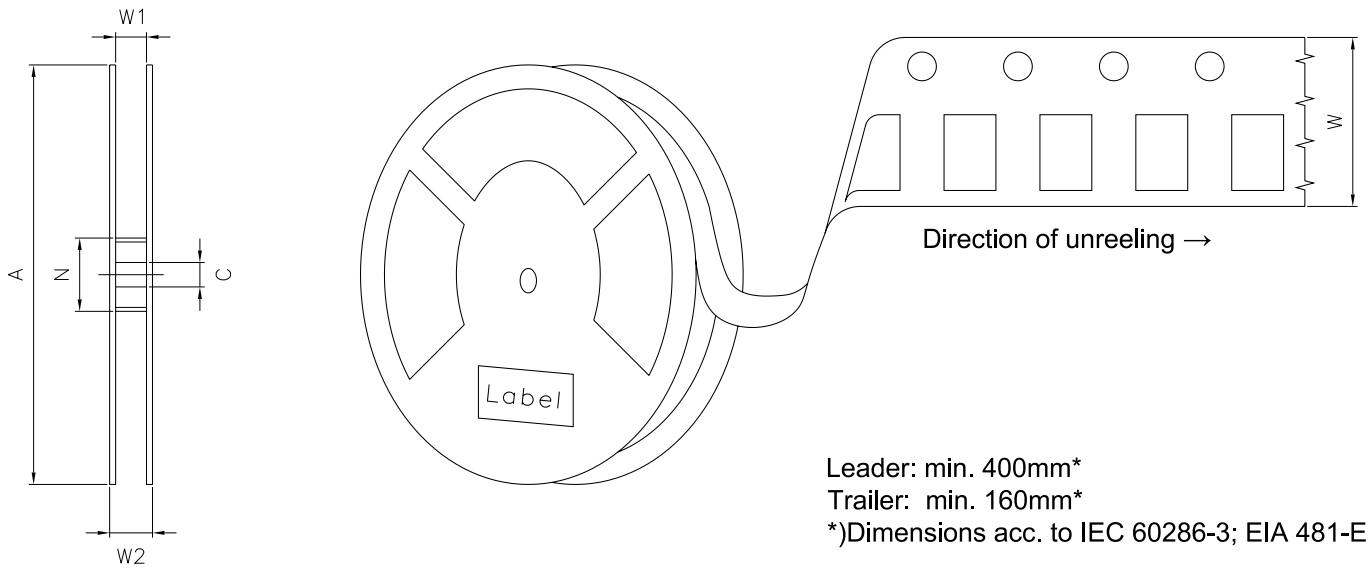

Reel Dimensions

| A | W | N _{min} | W ₁ | W _{2max} | Pieces per PU |
|--------|---------------------|------------------|----------------|-------------------|---------------|
| 180 mm | 12 + 0.3 / - 0.1 mm | 60 mm | 12.4 + 2 mm | 18.4 mm | 2000 |

Barcode-Product-Label (BPL)

OSRAM Opto Semiconductors LX XXXX BIN1: XX-XX-X-XXX-X

RoHS Compliant

(6P) BATCH NO: 1234567890 ML Temp ST
X XXX °C X

(1T) LOT NO: 1234567890 (9D) D/C: 1234 Pack: RXX
DEMY XXX
X_X123_1234.1234 X

(X) PROD NO: 123456789(Q)QTY: 9999 (G) GROUP: XX-XX-X-X

The diagram shows a rectangular label with rounded corners. It contains the OSRAM logo and product name at the top left. To the right are fields for 'LX XXXX' and 'BIN1: XX-XX-X-XXX-X'. Below the logo is a 'RoHS Compliant' statement. The label features three horizontal barcode sections. The first is labeled '(6P) BATCH NO: 1234567890' and is accompanied by a 'no liquid' symbol and 'ML Temp ST X XXX °C X'. The second is labeled '(1T) LOT NO: 1234567890' and '(9D) D/C: 1234' and is accompanied by 'Pack: RXX', 'DEMY XXX', and 'X_X123_1234.1234 X'. The third is labeled '(X) PROD NO: 123456789(Q)QTY: 9999' and '(G) GROUP: XX-XX-X-X'. A square QR code is located on the right side of the label.

OHA04563

Dry Packing Process and Materials ⁸⁾

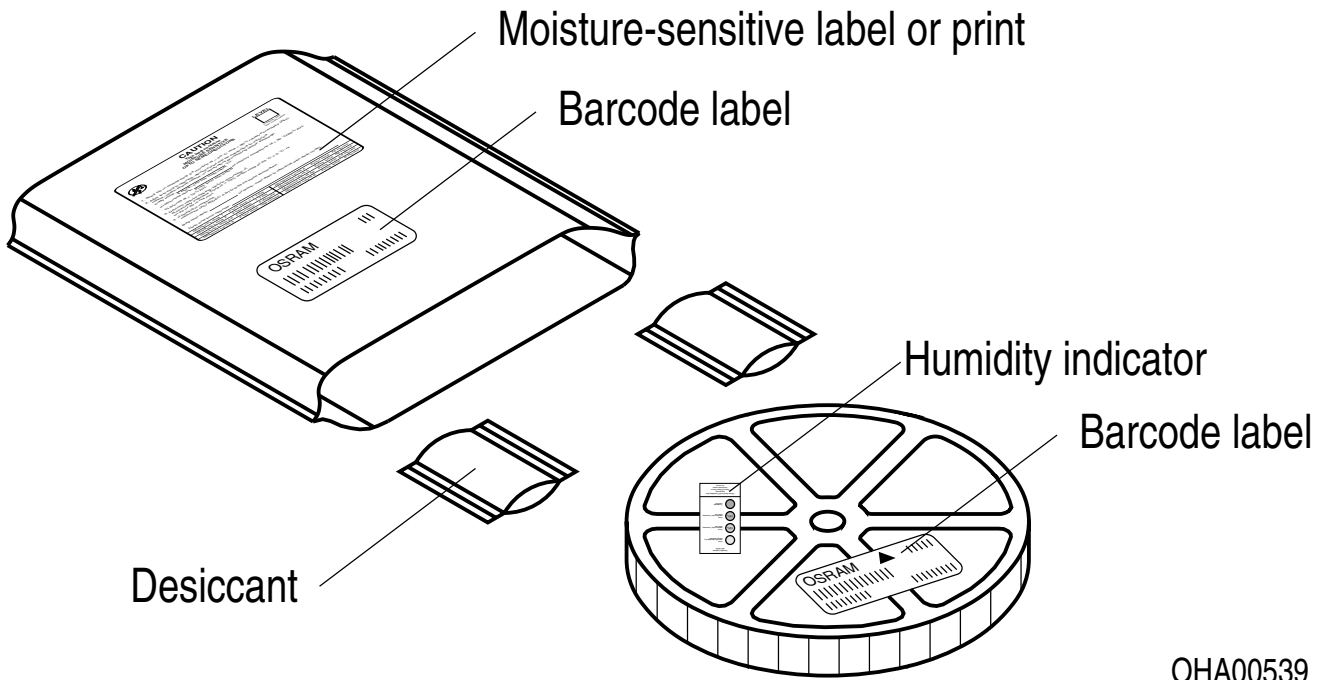

OHA00539

Moisture-sensitive product is packed in a dry bag containing desiccant and a humidity card according JEDEC-STD-033.

Notes

The evaluation of eye safety occurs according to the standard IEC 62471:2006 (photo biological safety of lamps and lamp systems). Within the risk grouping system of this IEC standard, the device specified in this data sheet falls into the class **exempt group (exposure time 10000 s)**. Under real circumstances (for exposure time, conditions of the eye pupils, observation distance), it is assumed that no endangerment to the eye exists from these devices. As a matter of principle, however, it should be mentioned that intense light sources have a high secondary exposure potential due to their blinding effect. When looking at bright light sources (e.g. headlights), temporary reduction in visual acuity and afterimages can occur, leading to irritation, annoyance, visual impairment, and even accidents, depending on the situation.

Subcomponents of this device contain, in addition to other substances, metal filled materials including silver. Metal filled materials can be affected by environments that contain traces of aggressive substances. Therefore, we recommend that customers minimize device exposure to aggressive substances during storage, production, and use. Devices that showed visible discoloration when tested using the described tests above did show no performance deviations within failure limits during the stated test duration. Respective failure limits are described in the IEC60810.

For further application related information please visit www.osram-os.com/appnotes

Disclaimer

Attention please!

The information describes the type of component and shall not be considered as assured characteristics. Terms of delivery and rights to change design reserved. Due to technical requirements components may contain dangerous substances.

For information on the types in question please contact our Sales Organization.

If printed or downloaded, please find the latest version on the OSRAM OS website.

Packing

Please use the recycling operators known to you. We can also help you – get in touch with your nearest sales office. By agreement we will take packing material back, if it is sorted. You must bear the costs of transport. For packing material that is returned to us unsorted or which we are not obliged to accept, we shall have to invoice you for any costs incurred.

Product and functional safety devices/applications or medical devices/applications

OSRAM OS components are not developed, constructed or tested for the application as safety relevant component or for the application in medical devices.

OSRAM OS products are not qualified at module and system level for such application.

In case buyer – or customer supplied by buyer – considers using OSRAM OS components in product safety devices/applications or medical devices/applications, buyer and/or customer has to inform the local sales partner of OSRAM OS immediately and OSRAM OS and buyer and /or customer will analyze and coordinate the customer-specific request between OSRAM OS and buyer and/or customer.

Glossary

- 1) **Reverse Operation:** This product is intended to be operated applying a forward current within the specified range. Applying any continuous reverse bias or forward bias below the voltage range of light emission shall be avoided because it may cause migration which can change the electro-optical characteristics or damage the LED.
- 2) **Wavelength:** The wavelength is measured at a current pulse of typically 25 ms, with an internal reproducibility of ± 0.5 nm and an expanded uncertainty of ± 1 nm (acc. to GUM with a coverage factor of $k = 3$).
- 3) **Forward Voltage:** Forward voltages are tested at a current pulse duration of 1 ms and a tolerance of ± 0.05 V and an expanded uncertainty of ± 0.1 V (acc. to GUM with a coverage factor of $k = 3$).
- 4) **Thermal Resistance:** $R_{th\ max}$ is based on statistic values (6σ).
- 5) **Brightness:** Brightness values are measured during a current pulse of typically 25 ms, with an internal reproducibility of ± 8 % and an expanded uncertainty of ± 11 % (acc. to GUM with a coverage factor of $k = 3$).
- 6) **Typical Values:** Due to the special conditions of the manufacturing processes of semiconductor devices, the typical data or calculated correlations of technical parameters can only reflect statistical figures. These do not necessarily correspond to the actual parameters of each single product, which could differ from the typical data and calculated correlations or the typical characteristic line. If requested, e.g. because of technical improvements, these typ. data will be changed without any further notice.
- 7) **Characteristic curve:** In the range where the line of the graph is broken, you must expect higher differences between single devices within one packing unit.
- 8) **Tolerance of Measure:** Unless otherwise noted in drawing, tolerances are specified with ± 0.1 and dimensions are specified in mm.
- 9) **Tape and Reel:** All dimensions and tolerances are specified acc. IEC 60286-3 and specified in mm.

Revision History

| Version | Date | Change |
|---------|------------|-----------------|
| 1.0 | 2020-11-24 | Initial Version |
| 1.1 | 2020-11-25 | Features |

Published by OSRAM Opto Semiconductors GmbH EU RoHS and China RoHS compliant product
Leibnizstraße 4, D-93055 Regensburg
www.osram-os.com © All Rights Reserved.



此产品符合欧盟 RoHS 指令的要求；
按照中国的相关法规和标准，不含有毒有害物质或元素。