

KRTB LFLP71.32

DISPLIX® P2828

This device is especially designed for full color video walls. The 6-lead technology allows for an additive mixture of color stimuli by independent driving of each chip. Very compact package size fits best for high resolution narrow pitch video walls.



Applications

- Video Walls Signage

Features:

- Chip technology: InGaAIP / InGaN on Sapphire
- Typ. Radiation: 120°
- Color: $\lambda_{\text{dom}} = 622 \text{ nm}$ (● red); $\lambda_{\text{dom}} = 528 \text{ nm}$ (● true green); $\lambda_{\text{dom}} = 472 \text{ nm}$ (● blue)
- ESD: 500V acc. to ANSI/ESDA/JEDEC JS-001 (HBM, Class 1B)

Ordering Information

Type	Brightness ¹⁾	Ordering Code
KRTBLFLP71.32-UVUZ-GP+VYAU-JS+SVSZ-SZ-B		Q65112A9639
• red	• $I_v = 529 \dots 900 \text{ mcd}$ ($I_F = 15 \text{ mA}$)	
• true green	• $I_v = 1000 \dots 1692 \text{ mcd}$ ($I_F = 10 \text{ mA}$)	
• blue	• $I_v = 212 \dots 355 \text{ mcd}$ ($I_F = 10 \text{ mA}$)	

Maximum Ratings

Parameter	Symbol		Values	Values	Values
			● red	● true green	● blue
Operating Temperature	T_{op}	min.	-40 °C	-40 °C	-40 °C
		max.	85 °C	85 °C	85 °C
Storage Temperature	T_{stg}	min.	-40 °C	-40 °C	-40 °C
		max.	100 °C	100 °C	100 °C
Junction Temperature	T_j	max.	110 °C	110 °C	110 °C
Forward Current $T_s = 25\text{ °C}$	I_F	max.	20 mA	20 mA	20 mA
Forward Current pulsed $D = 0.125 ; T_s = 25\text{ °C}$	$I_{F\ pulse}$	max.	40 mA	40 mA	40 mA
Reverse voltage ²⁾ $T_s = 25\text{ °C}$	V_R	max.	5 V	5 V	5 V
ESD withstand voltage acc. to ANSI/ESDA/JEDEC JS-001 (HBM, Class 1B)	V_{ESD}		500 V	500 V	500 V

Characteristics

$I_F = 15 \text{ mA}$ (red chip); $I_F = 10 \text{ mA}$ (true green and blue chip); $T_S = 25 \text{ }^\circ\text{C}$

Parameter	Symbol		Values	Values	Values
			● red	● true green	● blue
Peak Wavelength	λ_{peak}	typ.	629 nm	518 nm	467 nm
Dominant Wavelength ³⁾	λ_{dom}	min.	618 nm	524 nm	470 nm
		typ.	622 nm	528 nm	472 nm
		max.	625 nm	532 nm	476 nm
Viewing angle at 50% I_V	2ϕ	typ.	110 °	110 °	110 °
Forward Voltage ⁴⁾ $I_F = 15 \text{ mA}$ (red chip); $I_F = 10 \text{ mA}$ (true green and blue chip); $T_S = 25 \text{ }^\circ\text{C}$	V_F	min.	1.60 V	2.30 V	2.40 V
		typ.	2.10 V	2.50 V	2.75 V
		max.	2.60 V	3.50 V	3.30 V
Reverse current ²⁾ $V_R = 10 \text{ V}$	I_R	typ.	0.01 μA	0.01 μA	0.01 μA
		max.	1 μA	1 μA	1 μA
Real thermal resistance junction/solderpoint ⁵⁾	$R_{\text{thJS real}}$	typ.	230 K / W	300 K / W	250 K / W
		max.	270 K / W	350 K / W	310 K / W

Remark Reverse Current:

This product is intended to be operated applying a forward current within the specified range. Applying any continuous reverse bias or forward bias below the voltage range of light emission shall be avoided because it may cause migration which can change the electro-optical characteristics or damage the LED.

Brightness Groups

- red

Group	Luminous Intensity ¹⁾	Luminous Intensity ¹⁾
	$I_F = 15 \text{ mA}$ min. I_v	$I_F = 15 \text{ mA}$ max. I_v
UV	529 mcd	710 mcd
UW	560 mcd	754 mcd
UX	594 mcd	800 mcd
UY	630 mcd	849 mcd
UZ	669 mcd	900 mcd

Brightness Groups

- true green

Group	Luminous Intensity ³⁾	Luminous Intensity ¹⁾
	$I_F = 10 \text{ mA}$ min. I_v	$I_F = 10 \text{ mA}$ max. I_v
VY	1000 mcd	1323 mcd
VZ	1058 mcd	1400 mcd
AS	1120 mcd	1492 mcd
AT	1183 mcd	1590 mcd
AU	1250 mcd	1692 mcd

Brightness Groups

- blue

Group	Luminous Intensity ¹⁾ $I_F = 10 \text{ mA}$ min. I_v	Luminous Intensity ¹⁾ $I_F = 10 \text{ mA}$ max. I_v
SV	212 mcd	280 mcd
SW	224 mcd	297 mcd
SX	237 mcd	315 mcd
SY	250 mcd	334 mcd
SZ	265 mcd	355 mcd

Wavelength Groups

- red

Group	Dominant Wavelength ³⁾	
	min. λ_{dom}	max. λ_{dom}
GP	618 nm	625 nm

Wavelength Groups

- true green

Group	Dominant Wavelength ³⁾	
	min. λ_{dom}	max. λ_{dom}
JP	524 nm	529 nm
MS	527 nm	532 nm

Wavelength Groups

- blue

Group	Dominant Wavelength ³⁾	
	min. λ_{dom}	max. λ_{dom}
SW	470 nm	474 nm
UZ	472 nm	476 nm

Chromaticity Coordinate Groups

• red

Group	Cx	Cy
GP	0.6703	0.3136
	0.6873	0.3126
	0.7006	0.2993
	0.6822	0.3010

Chromaticity Coordinate Groups

• true green

Group	Cx	Cy
JP	0.1515	0.7300
	0.1203	0.7979
	0.1563	0.7861
	0.1805	0.7240
MS	0.1691	0.7267
	0.1423	0.7908
	0.1763	0.7794
	0.1968	0.7210

Chromaticity Coordinate Groups

• blue

Group	Cx	Cy
SW	0.1363	0.0738
	0.1258	0.0600
	0.1159	0.0834
	0.1276	0.0969
UZ	0.1327	0.0851
	0.1211	0.0708
	0.1099	0.0983
	0.1222	0.1112

Relative Spectral Emission ⁶⁾

$I_{rel} = f(\lambda); I_F = 15 \text{ mA}; T_S = 25 \text{ }^\circ\text{C}$

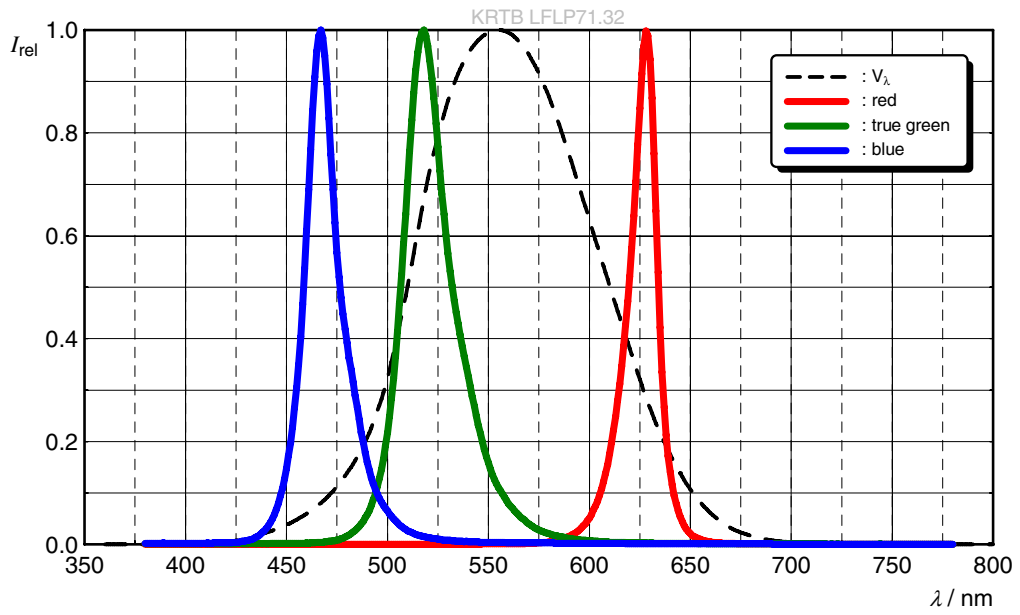

Radiation Characteristic (horizontal) ⁶⁾

$I_{rel} = f(\phi); T_S = 25\text{ }^\circ\text{C}$

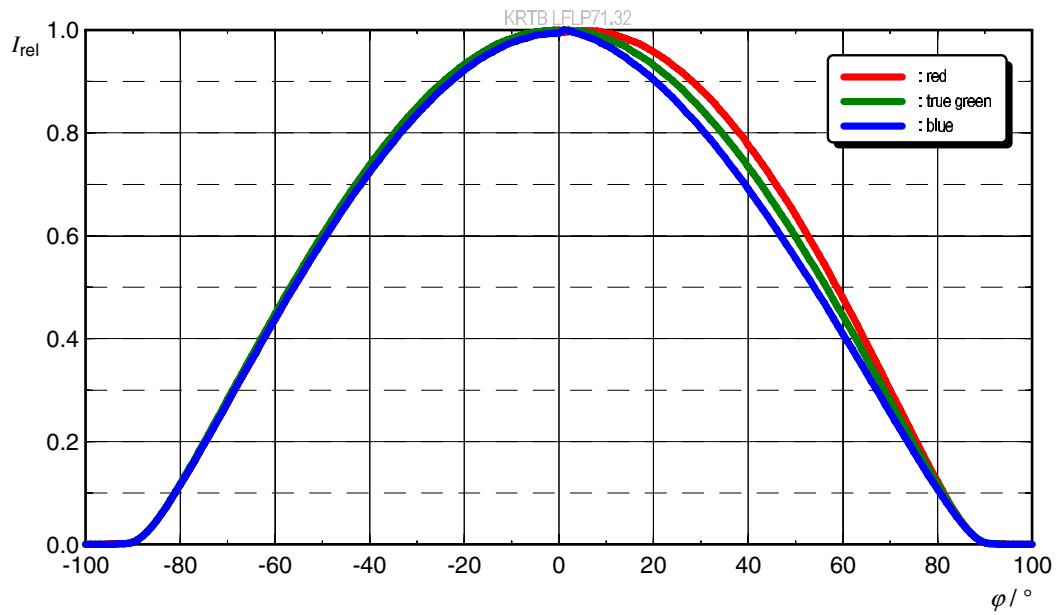

Radiation Characteristic (vertical) ⁶⁾

$I_{rel} = f(\phi); T_S = 25\text{ }^\circ\text{C}$

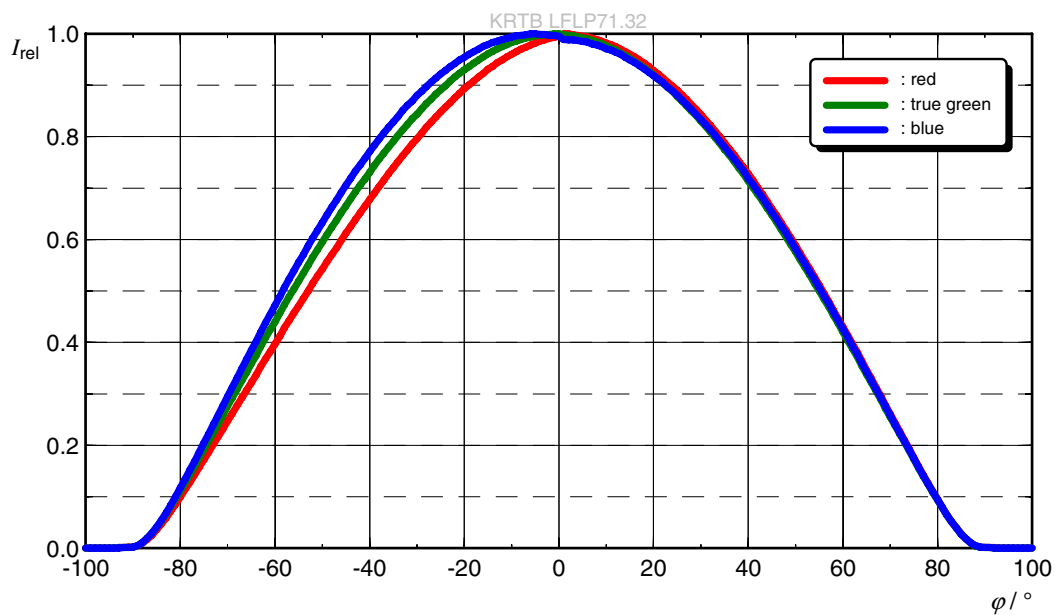

Forward current ⁶⁾

$I_F = f(V_F); T_S = 25\text{ °C}$

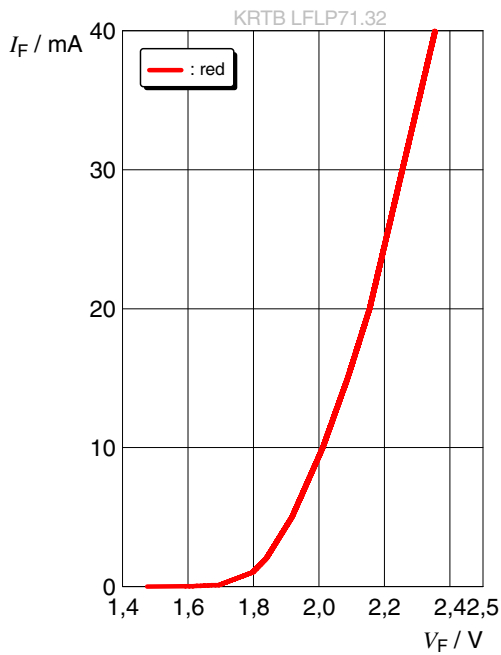

Forward current ⁶⁾

$I_F = f(V_F); T_S = 25\text{ °C}$

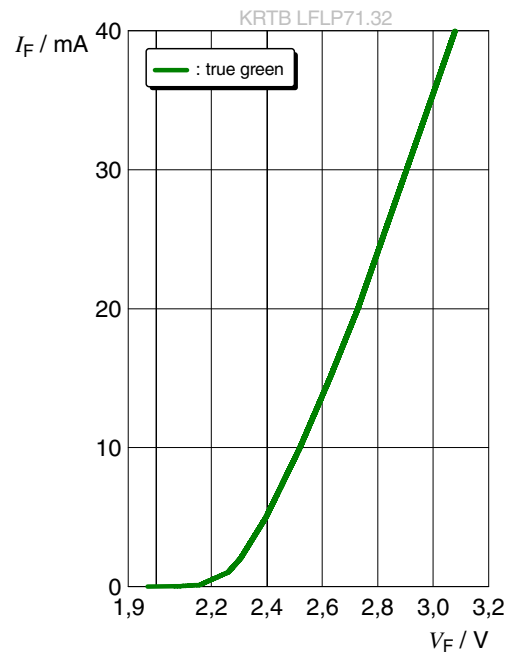

Forward current ⁶⁾

$I_F = f(V_F); T_S = 25\text{ °C}$

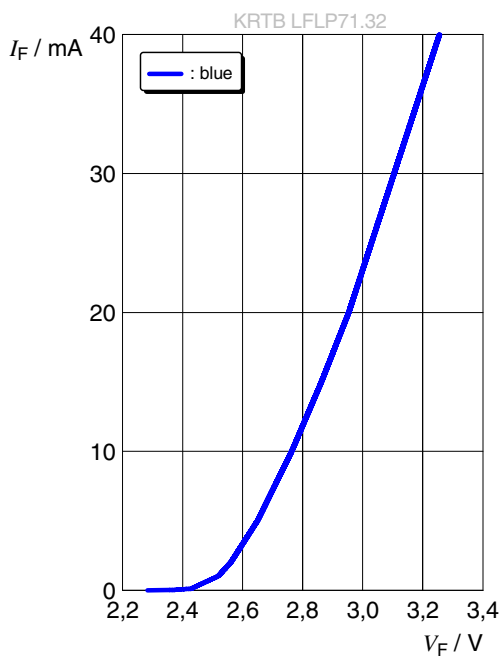

Relative Luminous Intensity 6), 7)

$I_V/I_V(15\text{ mA}) = f(I_F); T_s = 25\text{ °C}$

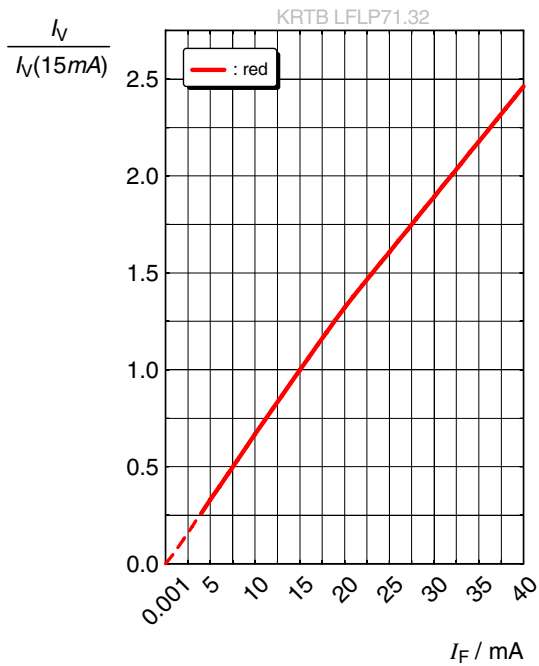

Relative Luminous Intensity 6), 7)

$I_V/I_V(10\text{ mA}) = f(I_F); T_s = 25\text{ °C}$

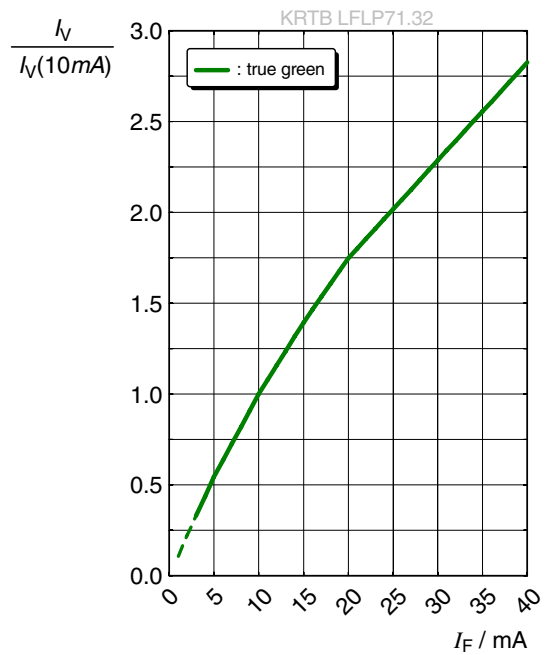

Relative Luminous Intensity 6), 7)

$I_V/I_V(10\text{ mA}) = f(I_F); T_s = 25\text{ °C}$

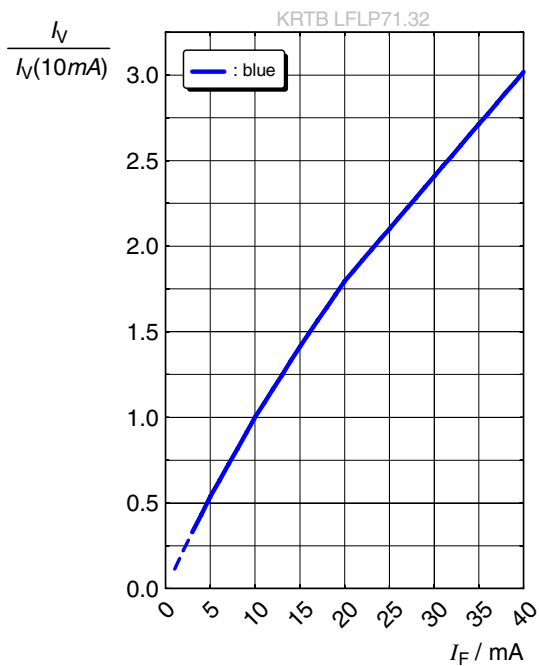

Dominant Wavelength ⁶⁾

$$\lambda_{\text{dom}} = f(I_F); T_S = 25 \text{ }^\circ\text{C}$$

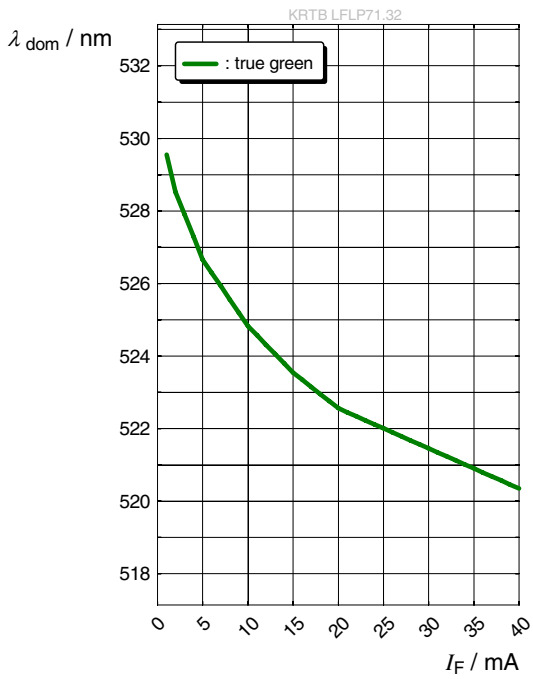

Dominant Wavelength ⁶⁾

$$\lambda_{\text{dom}} = f(I_F); T_S = 25 \text{ }^\circ\text{C}$$

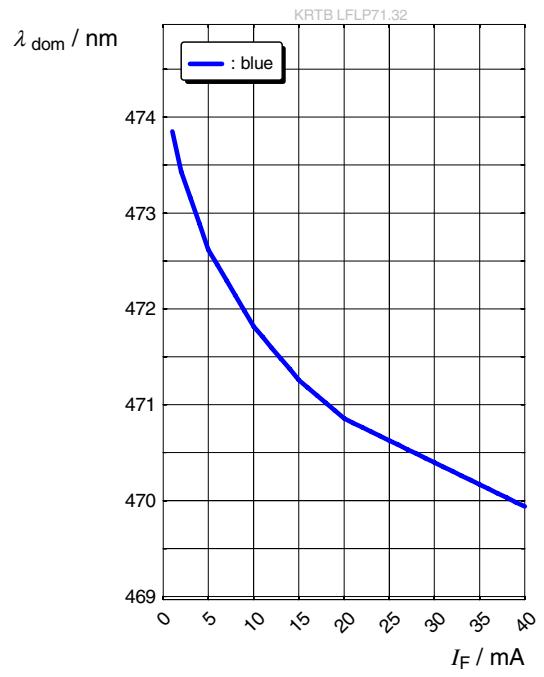

Forward Voltage ⁶⁾

$$\Delta V_F = V_F - V_F(25\text{ }^\circ\text{C}) = f(T_j); I_F = 15\text{ mA}$$

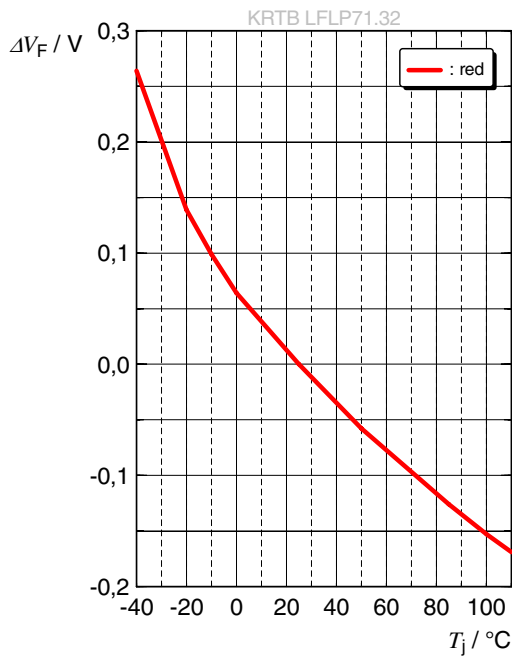

Forward Voltage ⁶⁾

$$\Delta V_F = V_F - V_F(25\text{ }^\circ\text{C}) = f(T_j); I_F = 10\text{ mA}$$

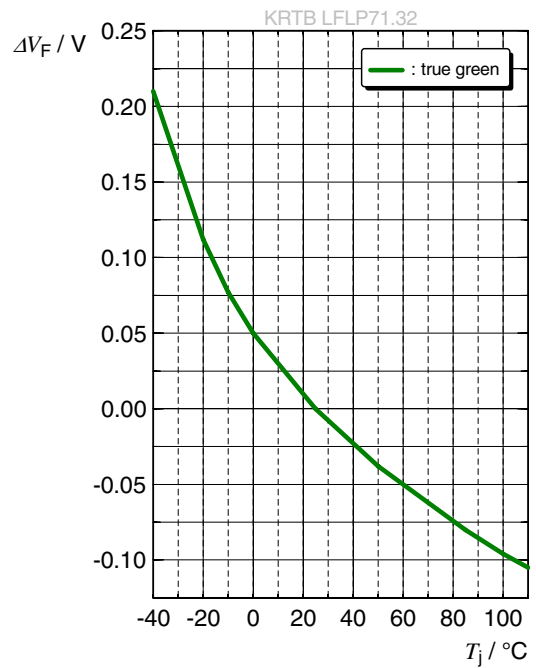

Forward Voltage ⁶⁾

$$\Delta V_F = V_F - V_F(25\text{ }^\circ\text{C}) = f(T_j); I_F = 10\text{ mA}$$

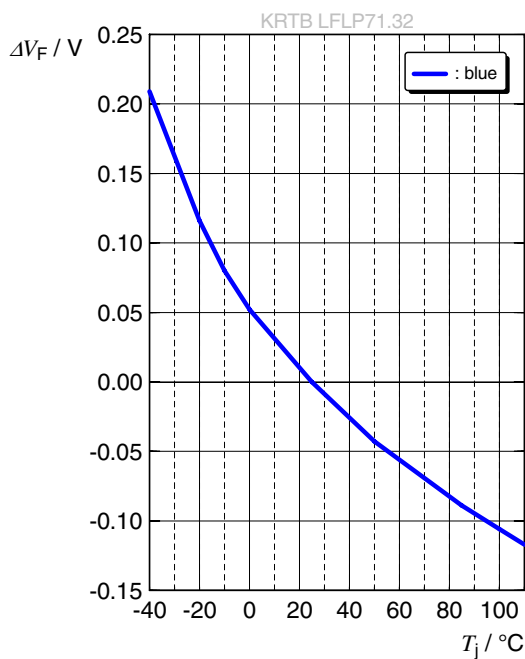

Relative Luminous Intensity ⁶⁾

$I_v/I_v(25\text{ °C}) = f(T_j); I_F = 15\text{ mA}$

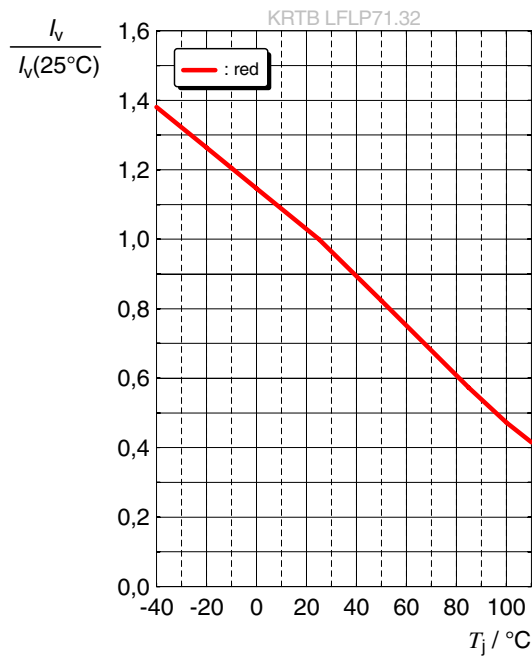

Relative Luminous Intensity ⁶⁾

$I_v/I_v(25\text{ °C}) = f(T_j); I_F = 10\text{ mA}$

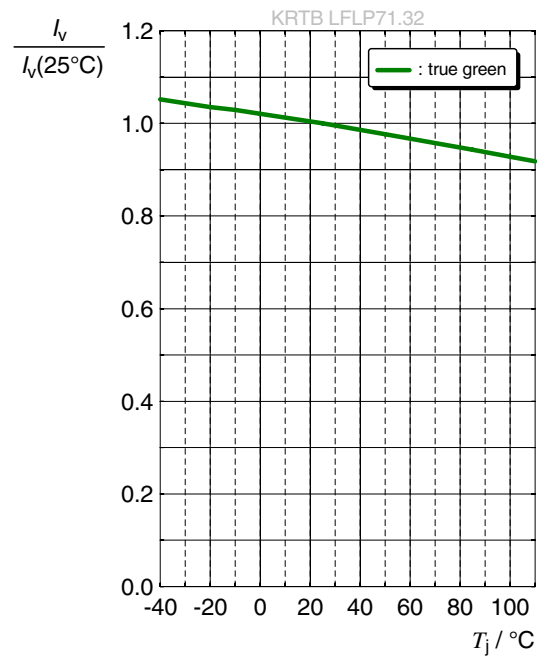

Relative Luminous Intensity ⁶⁾

$I_v/I_v(25\text{ °C}) = f(T_j); I_F = 10\text{ mA}$

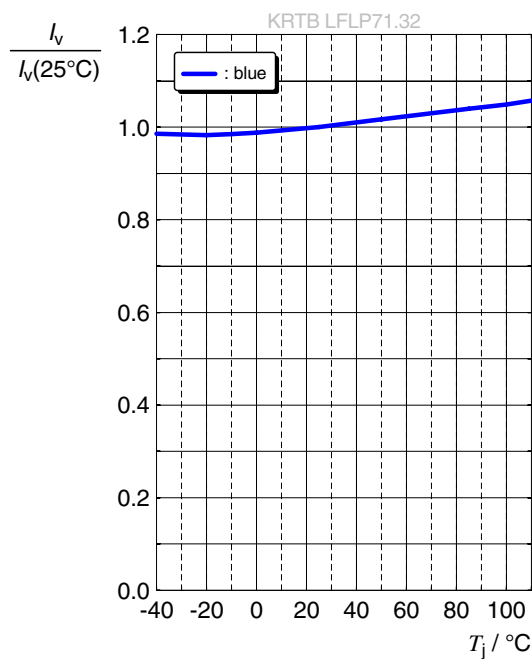

Dominant Wavelength ⁶⁾

$$\Delta\lambda_{\text{dom}} = \lambda_{\text{dom}} - \lambda_{\text{dom}}(25\text{ °C}) = f(T_j); I_F = 15\text{ mA}$$

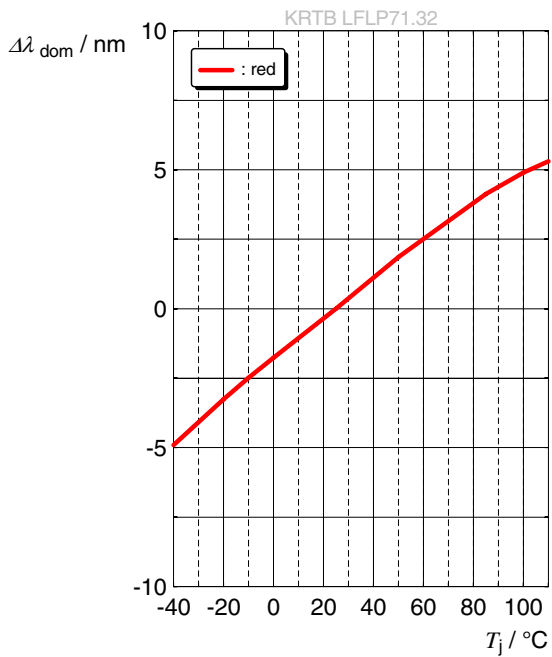

Dominant Wavelength ⁶⁾

$$\Delta\lambda_{\text{dom}} = \lambda_{\text{dom}} - \lambda_{\text{dom}}(25\text{ °C}) = f(T_j); I_F = 10\text{ mA}$$

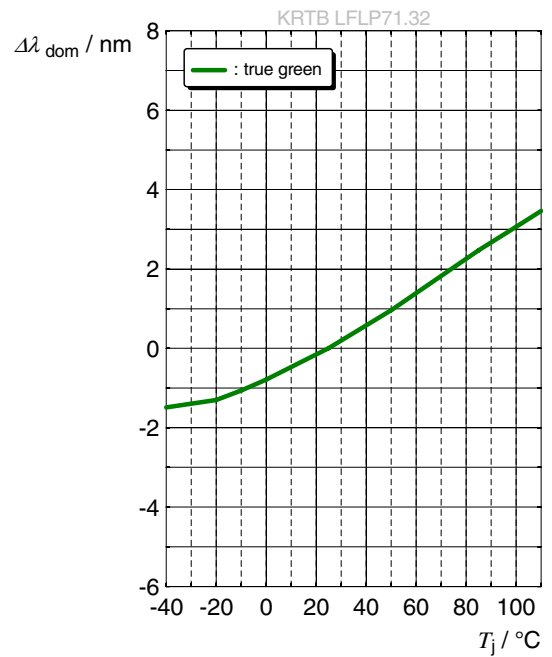

Dominant Wavelength ⁶⁾

$$\Delta\lambda_{\text{dom}} = \lambda_{\text{dom}} - \lambda_{\text{dom}}(25\text{ °C}) = f(T_j); I_F = 10\text{ mA}$$

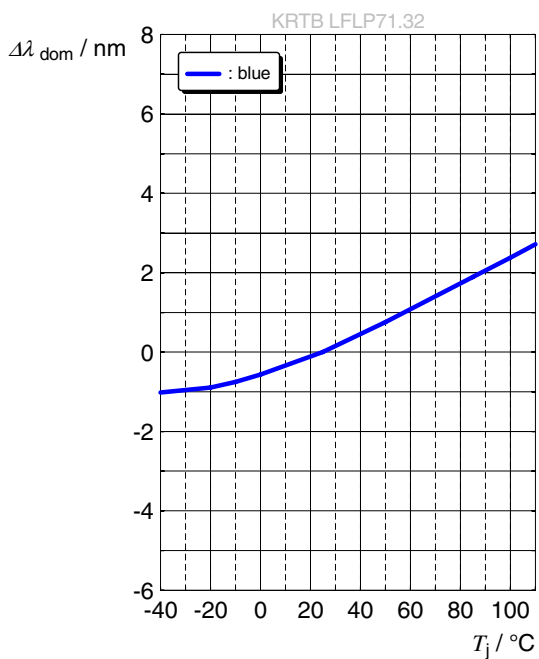

Max. Permissible Forward Current

$I_F = f(T)$; ● red

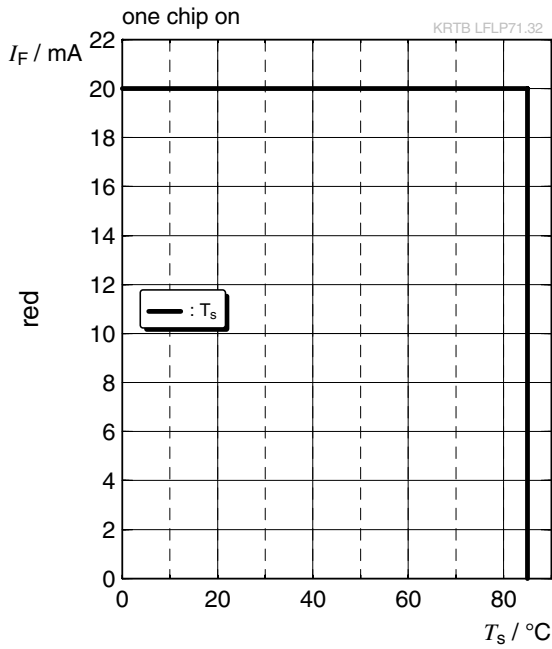

Max. Permissible Forward Current

$I_F = f(T)$; ● true green

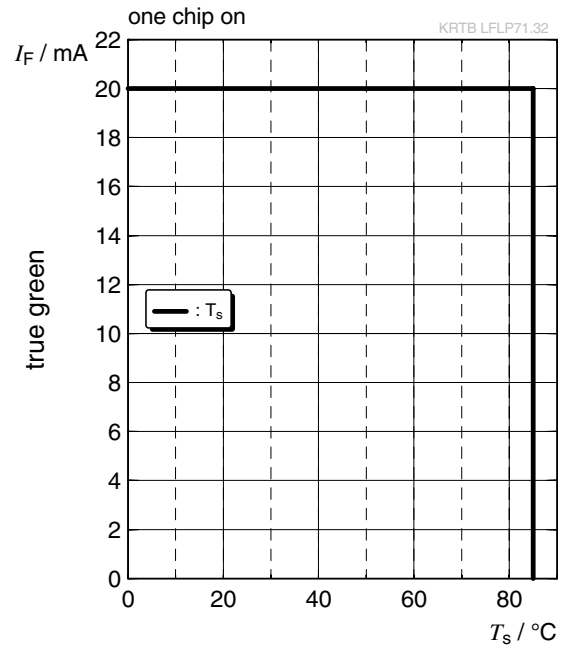

Max. Permissible Forward Current

$I_F = f(T)$; ● blue

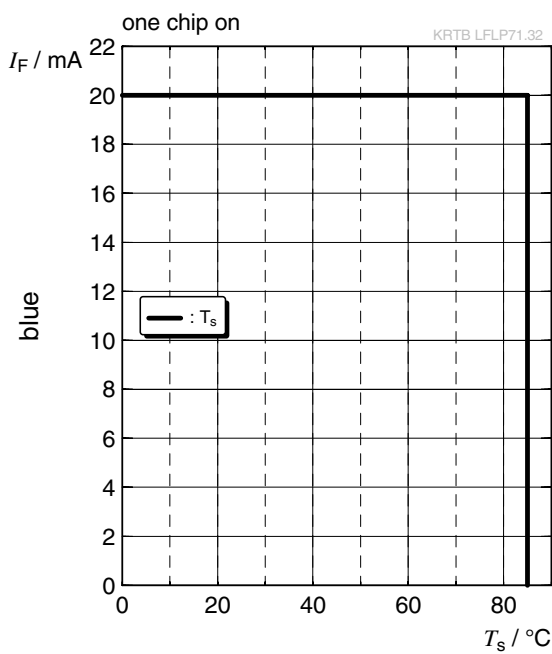

Permissible Pulse Handling Capability

$I_F = f(t_p)$; D: Duty cycle; $T_S = 25\text{ °C}$; ● red

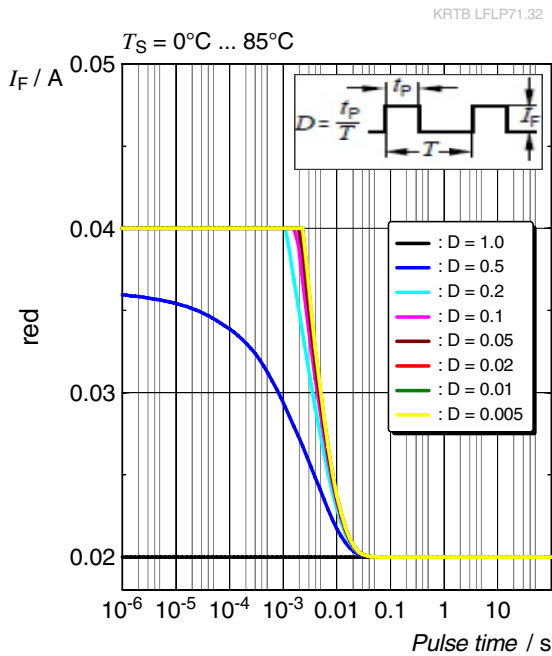

Permissible Pulse Handling Capability

$I_F = f(t_p)$; D: Duty cycle; $T_S = 25\text{ °C}$; ● true green

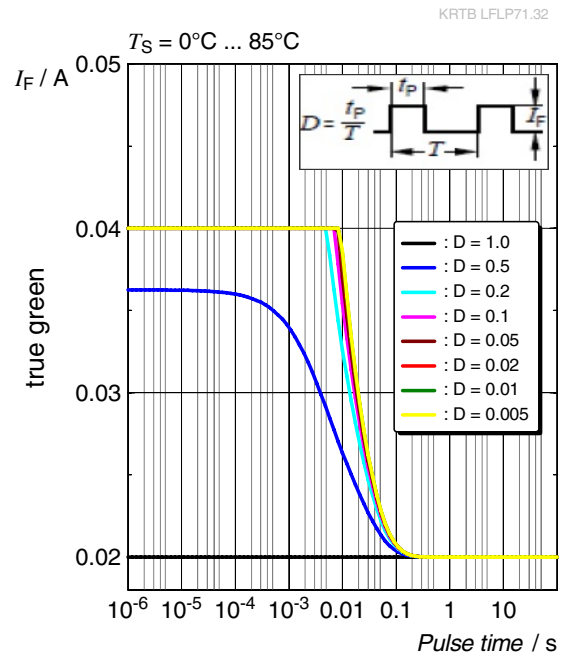

Permissible Pulse Handling Capability

$I_F = f(t_p)$; D: Duty cycle; $T_S = 25\text{ °C}$; ● blue

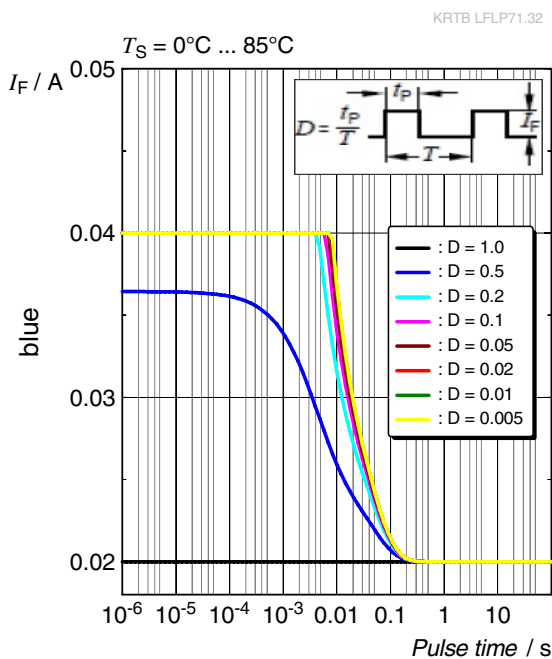

Preliminary datasheet version

Dimensional Drawing ⁸⁾

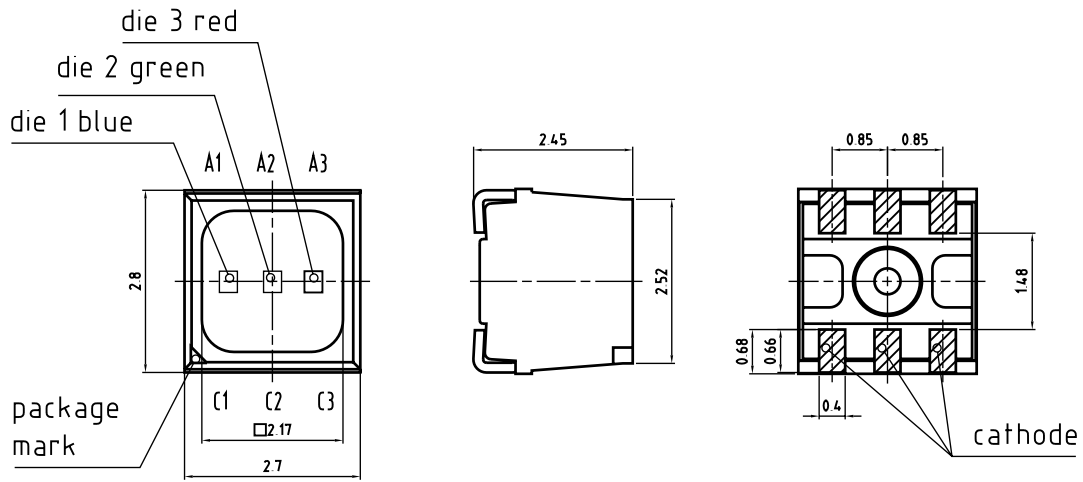

general tolerance ± 0.1
 lead finish Ag

C63062-A4379-A1-01

Further Information:

Approximate Weight: 33.0 mg

Electrical Internal Circuit

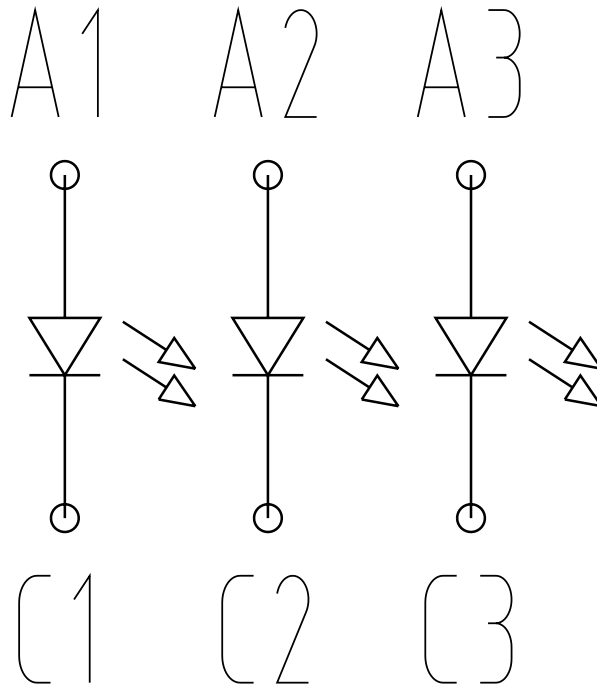

Recommended Solder Pad ⁸⁾

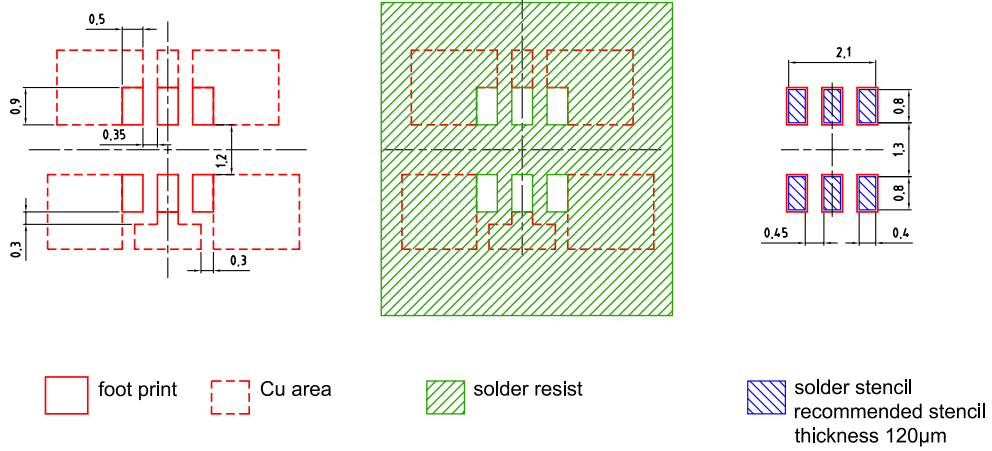

Component Location on Pad

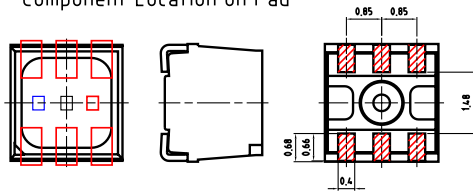

E062.3010.254-01

For superior solder joint connectivity results we recommend soldering under standard nitrogen atmosphere. Package not suitable for ultra sonic cleaning.

Reflow Soldering Profile

Product complies to MSL Level 4 acc. to JEDEC J-STD-020E

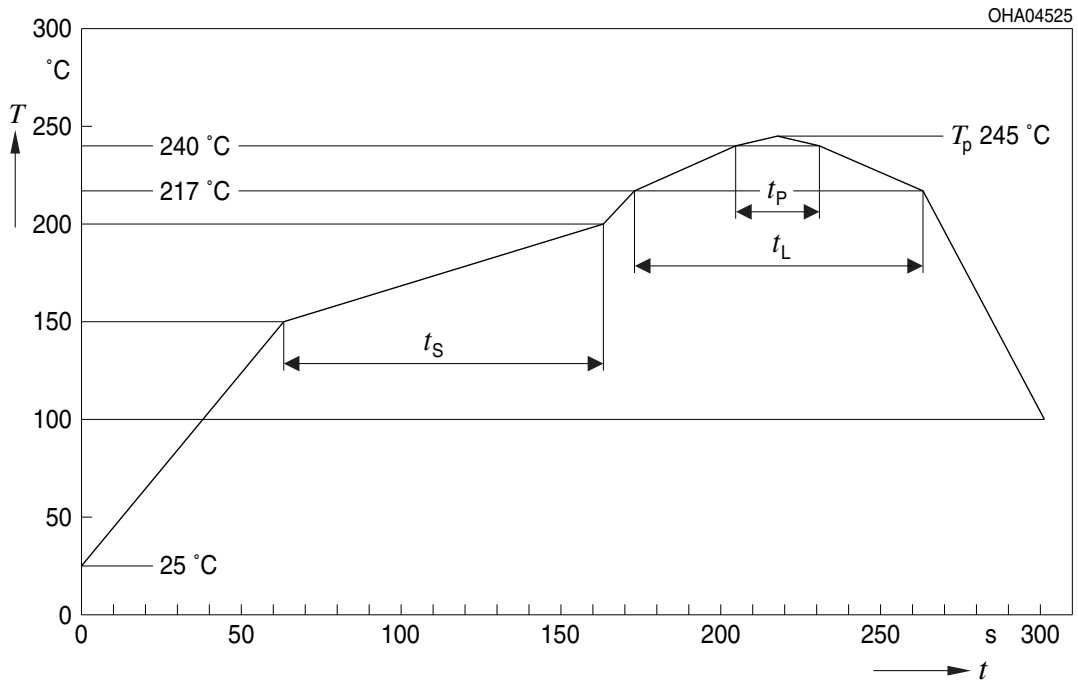

Profile Feature	Symbol	Pb-Free (SnAgCu) Assembly			Unit
		Minimum	Recommendation	Maximum	
Ramp-up rate to preheat ^{*)} 25 °C to 150 °C			2	3	K/s
Time t_s T_{Smin} to T_{Smax}	t_s	60	100	120	s
Ramp-up rate to peak ^{*)} T_{Smax} to T_p			2	3	K/s
Liquidus temperature	T_L		217		°C
Time above liquidus temperature	t_L		80	100	s
Peak temperature	T_p		245	260	°C
Time within 5 °C of the specified peak temperature $T_p - 5$ K	t_p	10	20	30	s
Ramp-down rate* T_p to 100 °C			3	6	K/s
Time 25 °C to T_p				480	s

All temperatures refer to the center of the package, measured on the top of the component
 *) slope calculation DT/Dt : Dt max. 5 s; fulfillment for the whole T-range

Preliminary datasheet version

Taping ⁸⁾

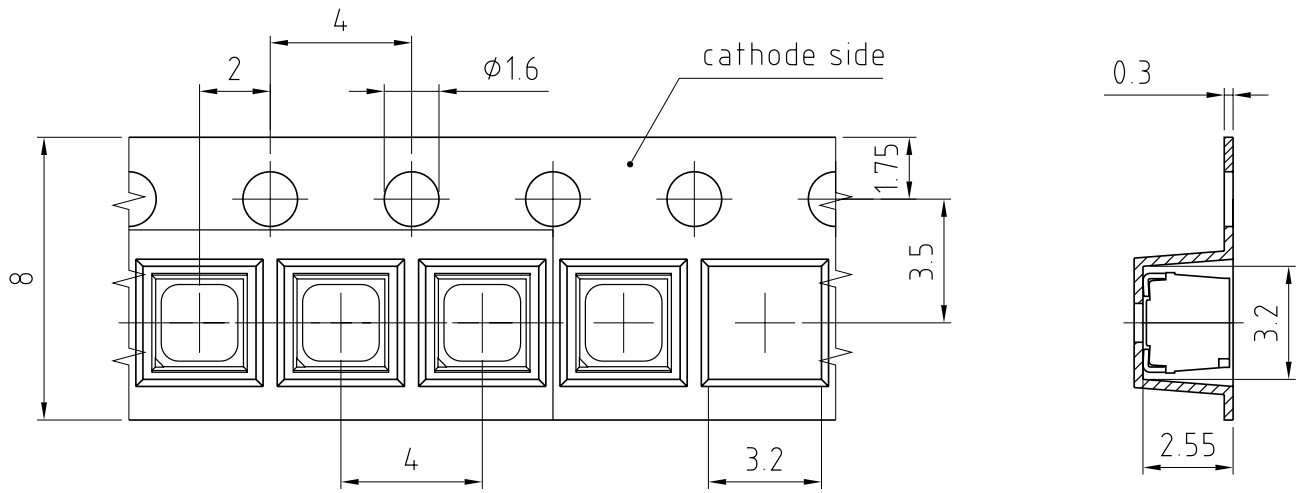

C63062-A4379-B1-01

Tape and Reel ⁹⁾

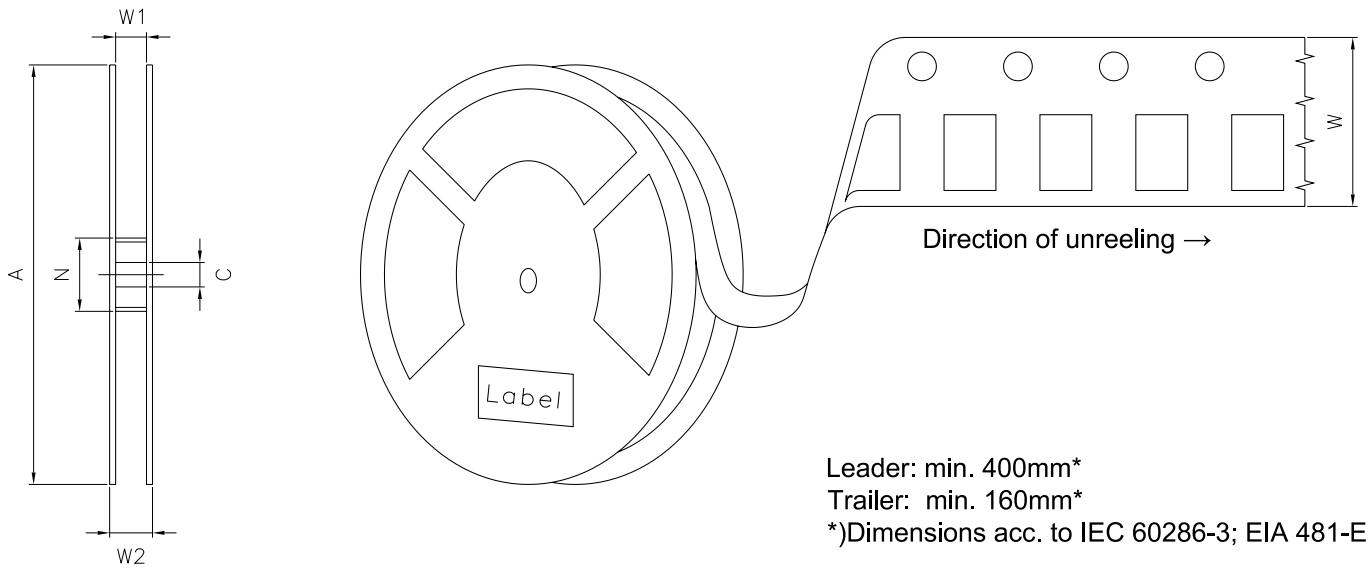

Reel Dimensions

A	W	N_{min}	W_1	W_{2max}	Pieces per PU
355.6 mm	8 + 0.3 / - 0.1 mm	79.3 mm	8.7 + 0.3 mm	14.4 mm	8000

Barcode-Product-Label (BPL)

OSRAM Opto Semiconductors LX XXXX BIN1: XX-XX-X-XXX-X

RoHS Compliant

(6P) BATCH NO: 1234567890 ML Temp ST
X XXX °C X

(1T) LOT NO: 1234567890 (9D) D/C: 1234 Pack: RXX
DEMY XXX
X_X123_1234.1234 X

(X) PROD NO: 123456789(Q)QTY: 9999 (G) GROUP: XX-XX-X-X

The diagram shows a rectangular label with rounded corners. It contains the OSRAM logo and company name at the top left. To the right are fields for 'LX XXXX' and 'BIN1: XX-XX-X-XXX-X'. Below the logo is 'RoHS Compliant'. The label features three horizontal barcode sections. The first is labeled '(6P) BATCH NO: 1234567890' and is accompanied by a 'No Moisture' symbol (a circle with a diagonal line and three raindrops) and 'ML Temp ST X XXX °C X'. The second is labeled '(1T) LOT NO: 1234567890' and '(9D) D/C: 1234' and is accompanied by 'Pack: RXX', 'DEMY XXX', and 'X_X123_1234.1234 X'. The third is labeled '(X) PROD NO: 123456789(Q)QTY: 9999' and '(G) GROUP: XX-XX-X-X'. A square QR code is located on the right side of the label.

OHA04563

Dry Packing Process and Materials ⁸⁾

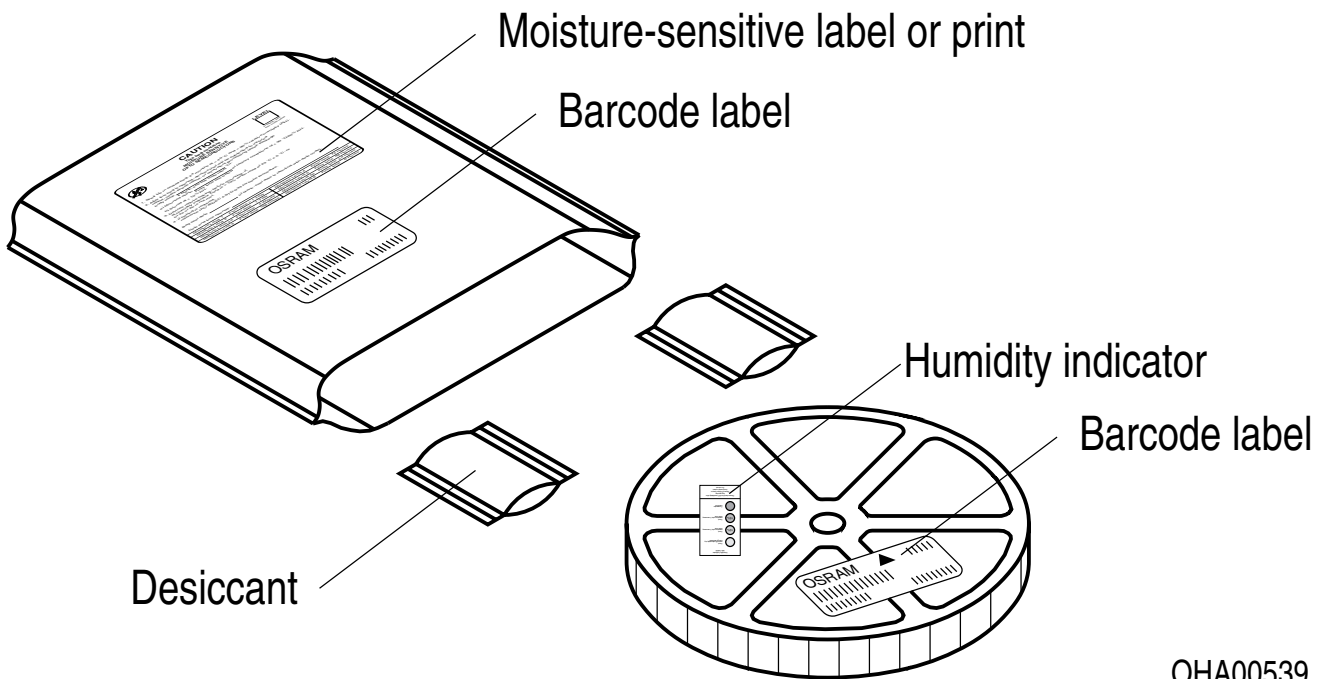

OHA00539

Moisture-sensitive product is packed in a dry bag containing desiccant and a humidity card according JEDEC-STD-033.

Notes

The evaluation of eye safety occurs according to the standard IEC 62471:2006 (photo biological safety of lamps and lamp systems). Within the risk grouping system of this IEC standard, the device specified in this data sheet falls into the class **exempt group (exposure time 10000 s)**. Under real circumstances (for exposure time, conditions of the eye pupils, observation distance), it is assumed that no endangerment to the eye exists from these devices. As a matter of principle, however, it should be mentioned that intense light sources have a high secondary exposure potential due to their blinding effect. When looking at bright light sources (e.g. headlights), temporary reduction in visual acuity and afterimages can occur, leading to irritation, annoyance, visual impairment, and even accidents, depending on the situation.

Subcomponents of this device contain, in addition to other substances, metal filled materials including silver. Metal filled materials can be affected by environments that contain traces of aggressive substances. Therefore, we recommend that customers minimize device exposure to aggressive substances during storage, production, and use. Devices that showed visible discoloration when tested using the described tests above did show no performance deviations within failure limits during the stated test duration. Respective failure limits are described in the IEC60810.

Changes to the content of this datasheet may occur without further notification. JEDEC 46C constitutes the guideline of the change management for the device specified in this document.

For further application related information please visit www.osram-os.com/appnotes

Disclaimer

OSRAM OS assumes no liability whatsoever for any use of this document or its content by recipient including, but not limited to, for any design in activities based on this preliminary draft version. OSRAM OS may e.g. decide at its sole discretion to stop developing and/or finalising the underlying design at any time.

Attention please!

The information describes the type of component and shall not be considered as assured characteristics. Terms of delivery and rights to change design reserved. Due to technical requirements components may contain dangerous substances.

For information on the types in question please contact our Sales Organization.

If printed or downloaded, please find the latest version on the OSRAM OS website.

Packing

Please use the recycling operators known to you. We can also help you – get in touch with your nearest sales office. By agreement we will take packing material back, if it is sorted. You must bear the costs of transport. For packing material that is returned to us unsorted or which we are not obliged to accept, we shall have to invoice you for any costs incurred.

Product and functional safety devices/applications or medical devices/applications

OSRAM OS components are not developed, constructed or tested for the application as safety relevant component or for the application in medical devices.

OSRAM OS products are not qualified at module and system level for such application.

In case buyer – or customer supplied by buyer – considers using OSRAM OS components in product safety devices/applications or medical devices/applications, buyer and/or customer has to inform the local sales partner of OSRAM OS immediately and OSRAM OS and buyer and /or customer will analyze and coordinate the customer-specific request between OSRAM OS and buyer and/or customer.

Glossary

- 1) **Brightness:** Brightness groups are tested at a current pulse duration of 25 ms and a tolerance of $\pm 11\%$.
- 2) **Reverse Operation:** Reverse Operation of 10 hours is permissible in total. Continuous reverse operation is not allowed.
- 3) **Wavelength:** Wavelengths are tested at a current pulse duration of 25 ms and a tolerance of ± 1 nm.
- 4) **Forward Voltage:** Forward voltages are tested at a current pulse duration of 1 ms and a tolerance of ± 0.1 V.
- 5) **Thermal Resistance:** $R_{th\ max}$ is based on statistic values (6σ).
- 6) **Typical Values:** Due to the special conditions of the manufacturing processes of semiconductor devices, the typical data or calculated correlations of technical parameters can only reflect statistical figures. These do not necessarily correspond to the actual parameters of each single product, which could differ from the typical data and calculated correlations or the typical characteristic line. If requested, e.g. because of technical improvements, these typ. data will be changed without any further notice.
- 7) **Characteristic curve:** In the range where the line of the graph is broken, you must expect higher differences between single devices within one packing unit.
- 8) **Tolerance of Measure:** Unless otherwise noted in drawing, tolerances are specified with ± 0.1 and dimensions are specified in mm.
- 9) **Tape and Reel:** All dimensions and tolerances are specified acc. IEC 60286-3 and specified in mm.

Revision History

Version	Date	Change
0.0	2020-04-02	Initial Version

Published by OSRAM Opto Semiconductors GmbH EU RoHS and China RoHS compliant product
Leibnizstraße 4, D-93055 Regensburg
www.osram-os.com © All Rights Reserved.



此产品符合欧盟 RoHS 指令的要求；
按照中国的相关法规和标准，不含有毒有害物质或元素。