

NTD4302

Power MOSFET 68 Amps, 30 Volts N-Channel DPAK

Features

- Ultra Low $R_{DS(on)}$
- Higher Efficiency Extending Battery Life
- Logic Level Gate Drive
- Diode Exhibits High Speed, Soft Recovery
- Avalanche Energy Specified
- I_{DSS} Specified at Elevated Temperature
- DPAK Mounting Information Provided
- Pb-Free Packages are Available

Applications

- DC-DC Converters
- Low Voltage Motor Control
- Power Management in Portable and Battery Powered Products: i.e., Computers, Printers, Cellular and Cordless Telephones, and PCMCIA Cards

MAXIMUM RATINGS ($T_C = 25^\circ\text{C}$ unless otherwise noted)

Rating	Symbol	Value	Unit
Drain-to-Source Voltage	V_{DSS}	30	Vdc
Gate-to-Source Voltage – Continuous	V_{GS}	± 20	Vdc
Thermal Resistance – Junction-to-Case	$R_{\theta JC}$	1.65	$^\circ\text{C}/\text{W}$
Total Power Dissipation @ $T_C = 25^\circ\text{C}$	P_D	75	W
Continuous Drain Current @ $T_C = 25^\circ\text{C}$ (Note 4)	I_D	68	A
Continuous Drain Current @ $T_C = 100^\circ\text{C}$	I_D	43	A
Thermal Resistance – Junction-to-Ambient (Note 2)	$R_{\theta JA}$	67	$^\circ\text{C}/\text{W}$
Total Power Dissipation @ $T_A = 25^\circ\text{C}$	P_D	1.87	W
Continuous Drain Current @ $T_A = 25^\circ\text{C}$	I_D	11.3	A
Continuous Drain Current @ $T_A = 100^\circ\text{C}$	I_D	7.1	A
Pulsed Drain Current (Note 3)	I_{DM}	36	A
Thermal Resistance – Junction-to-Ambient (Note 1)	$R_{\theta JA}$	120	$^\circ\text{C}/\text{W}$
Total Power Dissipation @ $T_A = 25^\circ\text{C}$	P_D	1.04	W
Continuous Drain Current @ $T_A = 25^\circ\text{C}$	I_D	8.4	A
Continuous Drain Current @ $T_A = 100^\circ\text{C}$	I_D	5.3	A
Pulsed Drain Current (Note 3)	I_{DM}	28	A
Operating and Storage Temperature Range	T_J, T_{stg}	-55 to 150	$^\circ\text{C}$
Single Pulse Drain-to-Source Avalanche Energy – Starting $T_J = 25^\circ\text{C}$ ($V_{DD} = 30\text{ Vdc}$, $V_{GS} = 10\text{ Vdc}$, Peak $I_L = 17\text{ Apk}$, $L = 5.0\text{ mH}$, $R_G = 25\ \Omega$)	E_{AS}	722	mJ
Maximum Lead Temperature for Soldering Purposes, 1/8 in from case for 10 seconds	T_L	260	$^\circ\text{C}$

Maximum ratings are those values beyond which device damage can occur. Maximum ratings applied to the device are individual stress limit values (not normal operating conditions) and are not valid simultaneously. If these limits are exceeded, device functional operation is not implied, damage may occur and reliability may be affected.

1. When surface mounted to an FR4 board using the minimum recommended pad size.
2. When surface mounted to an FR4 board using 0.5 sq. in. drain pad size.
3. Pulse Test: Pulse Width = 300 μs , Duty Cycle = 2%.
4. Current Limited by Internal Lead Wires.



ON Semiconductor®

<http://onsemi.com>

$V_{(BR)DSS}$	$R_{DS(on)}$ TYP	I_D MAX
30 V	7.8 m Ω @ 10 V	68 A

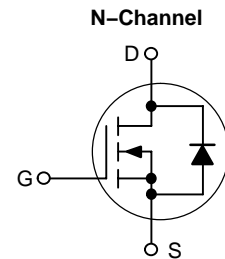

MARKING DIAGRAMS & PIN ASSIGNMENTS

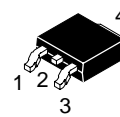

DPAK
CASE 369C
(Surface Mount)
STYLE 2

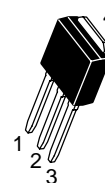
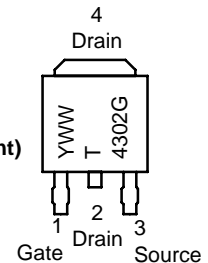

DPAK
CASE 369D
(Straight Lead)
STYLE 2

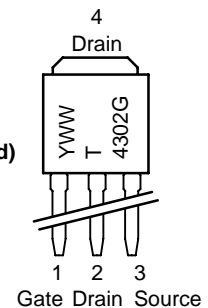

Y = Year
WW = Work Week
T4302 = Device Code
G = Pb-Free Package

ORDERING INFORMATION

See detailed ordering and shipping information in the package dimensions section on page 5 of this data sheet.

NTD4302

ELECTRICAL CHARACTERISTICS (T_J = 25°C unless otherwise noted)

Characteristic	Symbol	Min	Typ	Max	Unit
----------------	--------	-----	-----	-----	------

OFF CHARACTERISTICS

Drain–Source Breakdown Voltage (V _{GS} = 0 Vdc, I _D = 250 μA) Positive Temperature Coefficient	V _{(BR)DSS}	30 –	– 25	– –	Vdc mV/°C
Zero Gate Voltage Drain Current (V _{GS} = 0 Vdc, V _{DS} = 30 Vdc, T _J = 25°C) (V _{GS} = 0 Vdc, V _{DS} = 30 Vdc, T _J = 125°C)	I _{DSS}	– –	– –	1.0 10	μAdc
Gate–Body Leakage Current (V _{GS} = ±20 Vdc, V _{DS} = 0 Vdc)	I _{GSS}	–	–	±100	nAdc

ON CHARACTERISTICS

Gate Threshold Voltage (V _{DS} = V _{GS} , I _D = 250 μAdc) Negative Temperature Coefficient	V _{GS(th)}	1.0 –	1.9 –3.8	3.0 –	Vdc
Static Drain–Source On–State Resistance (V _{GS} = 10 Vdc, I _D = 20 Adc) (V _{GS} = 10 Vdc, I _D = 10 Adc) (V _{GS} = 4.5 Vdc, I _D = 5.0 Adc)	R _{DS(on)}	– – –	0.0078 0.0078 0.010	0.010 0.010 0.013	Ω
Forward Transconductance (V _{DS} = 15 Vdc, I _D = 10 Adc)	g _{FS}	–	20	–	Mhos

DYNAMIC CHARACTERISTICS

Input Capacitance	(V _{DS} = 24 Vdc, V _{GS} = 0 Vdc, f = 1.0 MHz)	C _{iss}	–	2050	2400	pF
Output Capacitance		C _{oss}	–	640	800	
Reverse Transfer Capacitance		C _{rss}	–	225	310	

SWITCHING CHARACTERISTICS (Note 6)

Turn–On Delay Time	(V _{DD} = 25 Vdc, I _D = 1.0 Adc, V _{GS} = 10 Vdc, R _G = 6.0 Ω)	t _{d(on)}	–	11	20	ns
Rise Time		t _r	–	15	25	
Turn–Off Delay Time		t _{d(off)}	–	85	130	
Fall Time		t _f	–	55	90	
Turn–On Delay Time	(V _{DD} = 25 Vdc, I _D = 1.0 Adc, V _{GS} = 10 Vdc, R _G = 2.5 Ω)	t _{d(on)}	–	11	20	ns
Rise Time		t _r	–	13	20	
Turn–Off Delay Time		t _{d(off)}	–	55	90	
Fall Time		t _f	–	40	75	
Turn–On Delay Time	(V _{DD} = 24 Vdc, I _D = 20 Adc, V _{GS} = 10 Vdc, R _G = 2.5 Ω)	t _{d(on)}	–	15	–	ns
Rise Time		t _r	–	25	–	
Turn–Off Delay Time		t _{d(off)}	–	40	–	
Fall Time		t _f	–	58	–	
Gate Charge	(V _{DS} = 24 Vdc, I _D = 2.0 Adc, V _{GS} = 10 Vdc)	Q _T	–	55	80	nC
		Q _{gs} (Q1)	–	5.5	–	
		Q _{gd} (Q2)	–	15	–	

BODY–DRAIN DIODE RATINGS (Note 5)

Diode Forward On–Voltage (I _S = 2.3 Adc, V _{GS} = 0 Vdc) (I _S = 20 Adc, V _{GS} = 0 Vdc) (I _S = 2.3 Adc, V _{GS} = 0 Vdc, T _J = 125°C)	V _{SD}	– – –	0.75 0.90 0.65	1.0 – –	Vdc	
Reverse Recovery Time	(I _S = 2.3 Adc, V _{GS} = 0 Vdc, di _S /dt = 100 A/μs)	t _{rr}	–	39	65	ns
		t _a	–	20	–	
		t _b	–	19	–	
Reverse Recovery Stored Charge	Q _{rr}	–	0.043	–	μC	

5. Indicates Pulse Test: Pulse Width = 300 μsec max, Duty Cycle ≤ 2%.

6. Switching characteristics are independent of operating junction temperature.

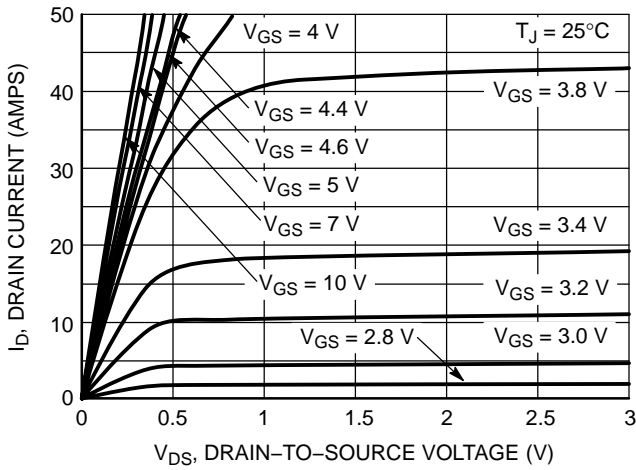

Figure 1. On-Region Characteristics

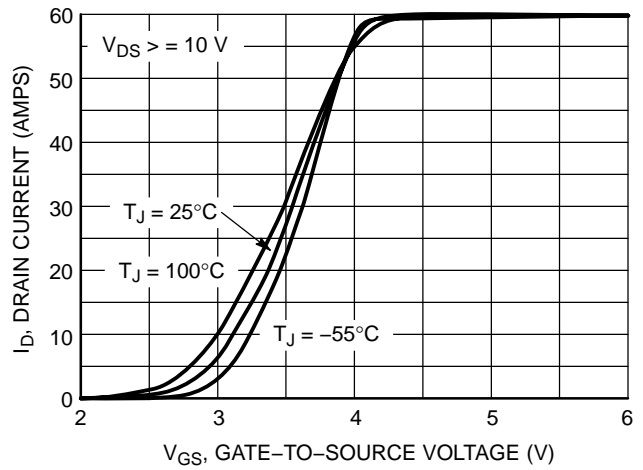

Figure 2. Transfer Characteristics

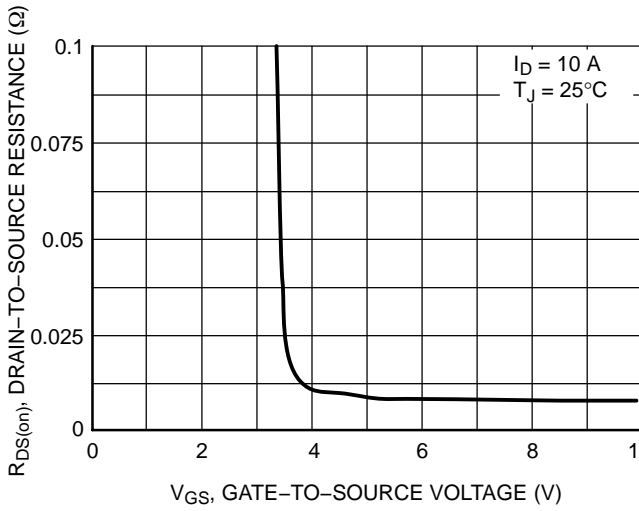

Figure 3. On-Resistance vs. Gate-To-Source Voltage

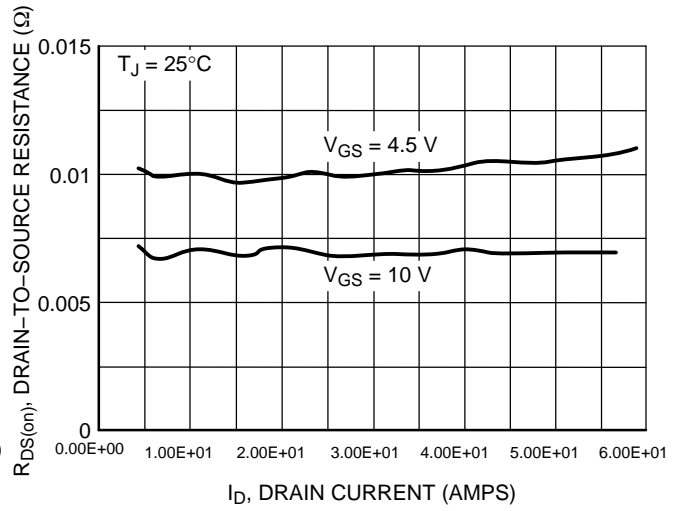

Figure 4. On-Resistance vs. Drain Current and Gate Voltage

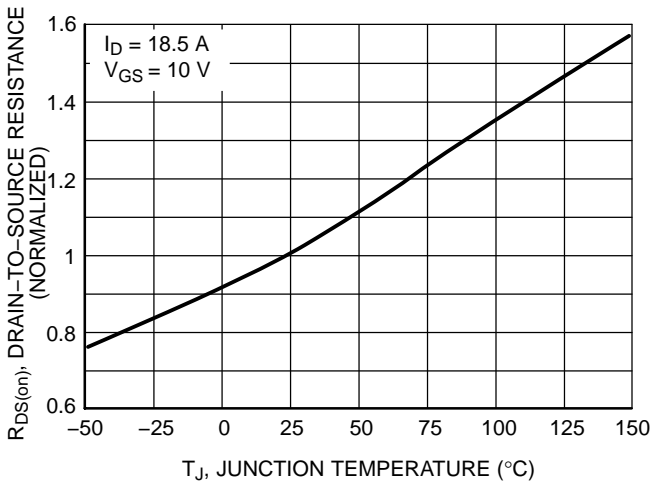

Figure 5. On-Resistance Variation with Temperature

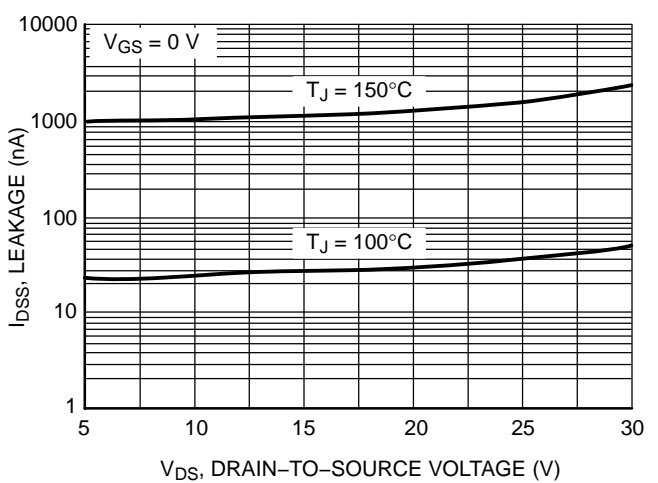

Figure 6. Drain-To-Source Leakage Current vs. Voltage

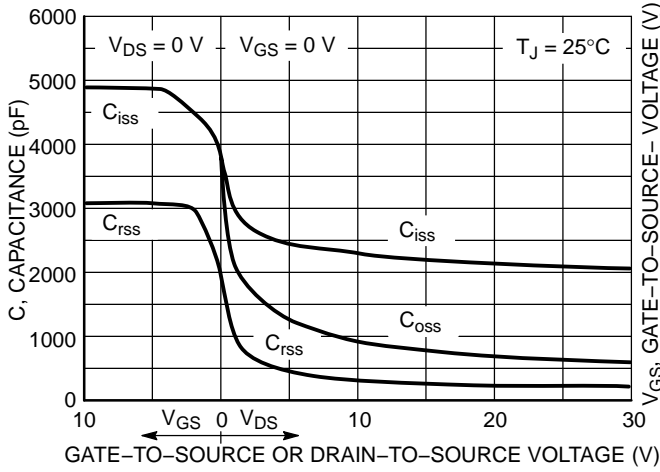

Figure 7. Capacitance Variation

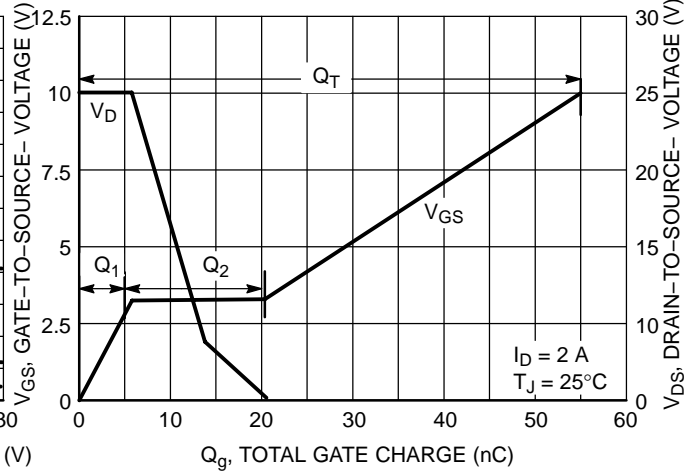

Figure 8. Gate-to-Source and Drain-to-Source Voltage vs. Total Charge

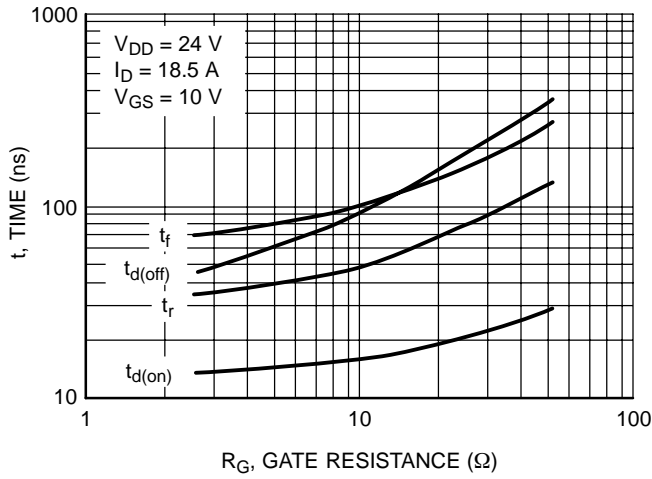

Figure 9. Resistive Switching Time Variation vs. Gate Resistance

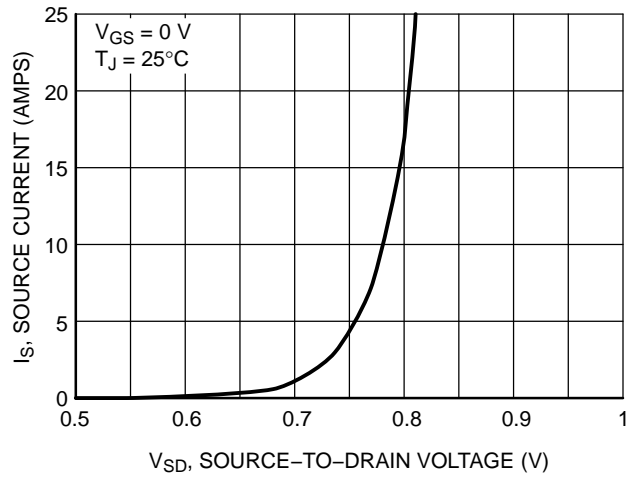

Figure 10. Diode Forward Voltage vs. Current

NTD4302

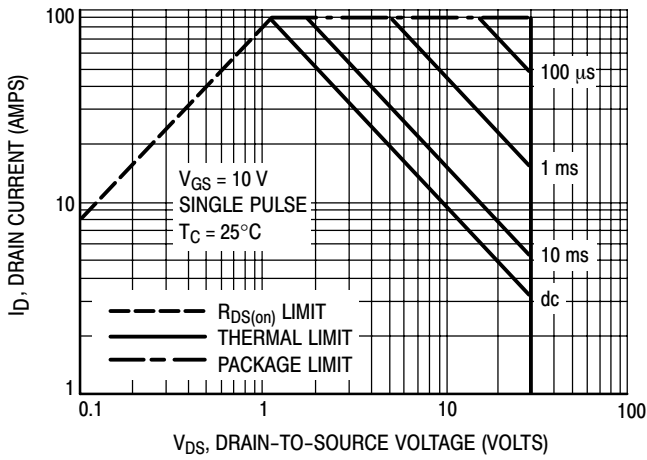

Figure 11. Maximum Rated Forward Biased Safe Operating Area

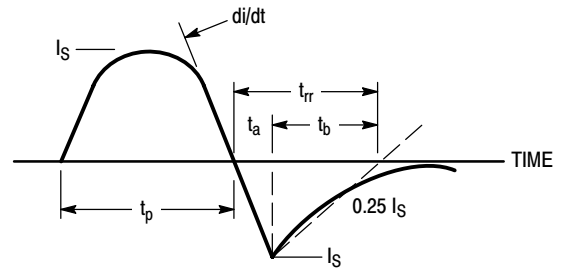

Figure 12. Diode Reverse Recovery Waveform

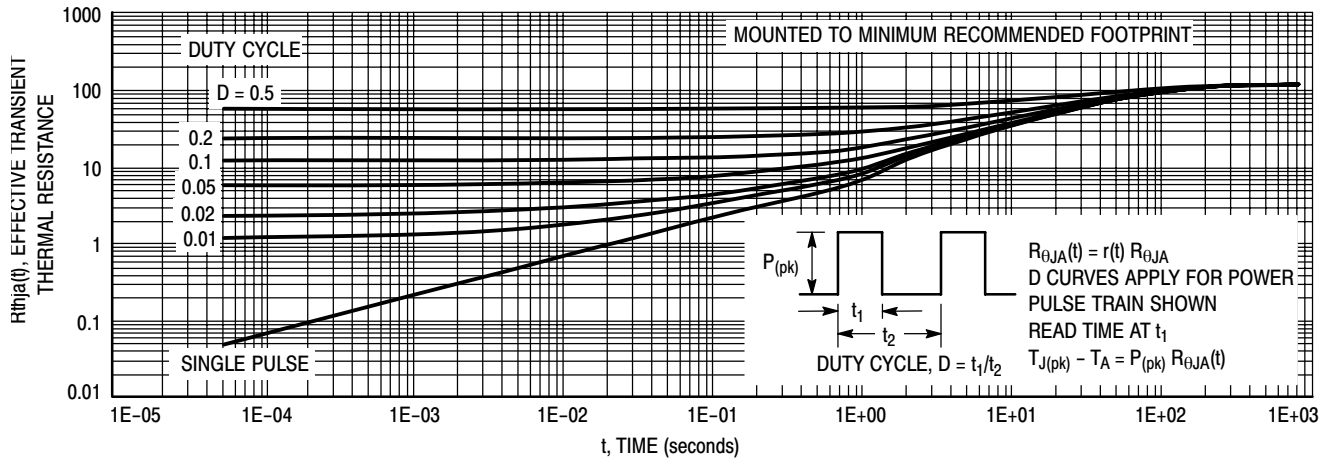

Figure 13. Thermal Response – Various Duty Cycles

ORDERING INFORMATION

Device	Package Type	Package	Shipping†
NTD4302	DPAK	369C	75 Units / Rail
NTD4302G	DPAK	369C (Pb-Free)	75 Units / Rail
NTD4302-001	DPAK-3	369D	75 Units / Rail
NTD4302-1G	DPAK-3	369D (Pb-Free)	75 Units / Rail
NTD4302T4	DPAK	369C	2500 Tape & Reel
NTD4302T4G	DPAK	369C (Pb-Free)	2500 Tape & Reel

†For information on tape and reel specifications, including part orientation and tape sizes, please refer to our Tape and Reel Packaging Specifications Brochure, BRD8011/D.

NTD4302

PACKAGE DIMENSIONS

DPAK
CASE 369C-01
ISSUE O

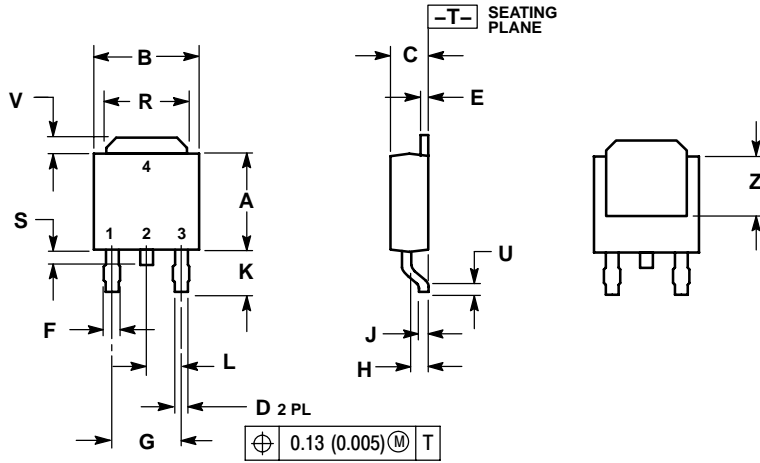

NOTES:
1. DIMENSIONING AND TOLERANCING PER ANSI Y14.5M, 1982.
2. CONTROLLING DIMENSION: INCH.

DIM	INCHES		MILLIMETERS	
	MIN	MAX	MIN	MAX
A	0.235	0.245	5.97	6.22
B	0.250	0.265	6.35	6.73
C	0.086	0.094	2.19	2.38
D	0.027	0.035	0.69	0.88
E	0.018	0.023	0.46	0.58
F	0.037	0.045	0.94	1.14
G	0.180	BSC	4.58	BSC
H	0.034	0.040	0.87	1.01
J	0.018	0.023	0.46	0.58
K	0.102	0.114	2.60	2.89
L	0.090	BSC	2.29	BSC
R	0.180	0.215	4.57	5.45
S	0.025	0.040	0.63	1.01
U	0.020	---	0.51	---
V	0.035	0.050	0.89	1.27
Z	0.155	---	3.93	---

STYLE 2:
PIN 1. GATE
2. DRAIN
3. SOURCE
4. DRAIN

SOLDERING FOOTPRINT*

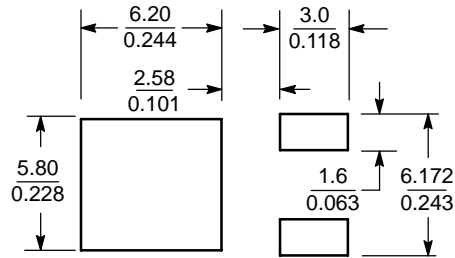

SCALE 3:1 $\left(\frac{\text{mm}}{\text{inches}}\right)$

*For additional information on our Pb-Free strategy and soldering details, please download the ON Semiconductor Soldering and Mounting Techniques Reference Manual, SOLDERRM/D.

NTD4302

PACKAGE DIMENSIONS

DPAK
CASE 369D-01
ISSUE B

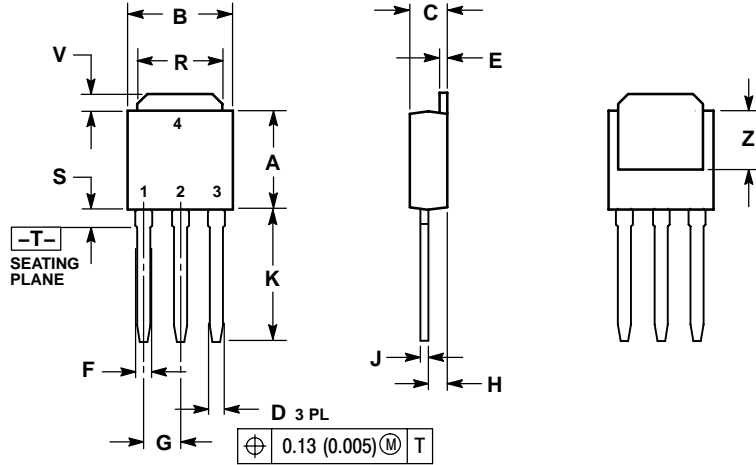

NOTES:

1. DIMENSIONING AND TOLERANCING PER ANSI Y14.5M, 1982.
2. CONTROLLING DIMENSION: INCH.

DIM	INCHES		MILLIMETERS	
	MIN	MAX	MIN	MAX
A	0.235	0.245	5.97	6.35
B	0.250	0.265	6.35	6.73
C	0.086	0.094	2.19	2.38
D	0.027	0.035	0.69	0.88
E	0.018	0.023	0.46	0.58
F	0.037	0.045	0.94	1.14
G	0.090 BSC		2.29 BSC	
H	0.034	0.040	0.87	1.01
J	0.018	0.023	0.46	0.58
K	0.350	0.380	8.89	9.65
R	0.180	0.215	4.45	5.45
S	0.025	0.040	0.63	1.01
V	0.035	0.050	0.89	1.27
Z	0.155	---	3.93	---

STYLE 2:

- PIN 1. GATE
- DRAIN
- SOURCE
- DRAIN

ON Semiconductor and are registered trademarks of Semiconductor Components Industries, LLC (SCILLC). SCILLC reserves the right to make changes without further notice to any products herein. SCILLC makes no warranty, representation or guarantee regarding the suitability of its products for any particular purpose, nor does SCILLC assume any liability arising out of the application or use of any product or circuit, and specifically disclaims any and all liability, including without limitation special, consequential or incidental damages. "Typical" parameters which may be provided in SCILLC data sheets and/or specifications can and do vary in different applications and actual performance may vary over time. All operating parameters, including "Typicals" must be validated for each customer application by customer's technical experts. SCILLC does not convey any license under its patent rights nor the rights of others. SCILLC products are not designed, intended, or authorized for use as components in systems intended for surgical implant into the body, or other applications intended to support or sustain life, or for any other application in which the failure of the SCILLC product could create a situation where personal injury or death may occur. Should Buyer purchase or use SCILLC products for any such unintended or unauthorized application, Buyer shall indemnify and hold SCILLC and its officers, employees, subsidiaries, affiliates, and distributors harmless against all claims, costs, damages, and expenses, and reasonable attorney fees arising out of, directly or indirectly, any claim of personal injury or death associated with such unintended or unauthorized use, even if such claim alleges that SCILLC was negligent regarding the design or manufacture of the part. SCILLC is an Equal Opportunity/Affirmative Action Employer. This literature is subject to all applicable copyright laws and is not for resale in any manner.

PUBLICATION ORDERING INFORMATION

LITERATURE FULFILLMENT:

Literature Distribution Center for ON Semiconductor
P.O. Box 61312, Phoenix, Arizona 85082-1312 USA
Phone: 480-829-7710 or 800-344-3860 Toll Free USA/Canada
Fax: 480-829-7709 or 800-344-3867 Toll Free USA/Canada
Email: orderlit@onsemi.com

N. American Technical Support: 800-282-9855 Toll Free
USA/Canada

Japan: ON Semiconductor, Japan Customer Focus Center
2-9-1 Kamimeguro, Meguro-ku, Tokyo, Japan 153-0051
Phone: 81-3-5773-3850

ON Semiconductor Website: <http://onsemi.com>

Order Literature: <http://www.onsemi.com/litorder>

For additional information, please contact your local Sales Representative.