

NL17SZU04

Single Unbuffered Inverter

The NL17SZU04 is a single unbuffered inverter in two tiny footprint packages. The device performs much as LCX multi-gate products in speed and drive.

Features

- Tiny SOT-353 and SOT-553 Packages
- Source/Sink ± 16 mA at 4.5 V V_{CC}
- Over-Voltage Tolerant Inputs and Outputs
- Pin For Pin with NC7SZU04P5X, TC7SZU04FU and TC7SZU04AFE
- Chip Complexity: FETs = 20
- Designed for 1.65 V to 5.5 V V_{CC} Operation
- Pb-Free Packages are Available

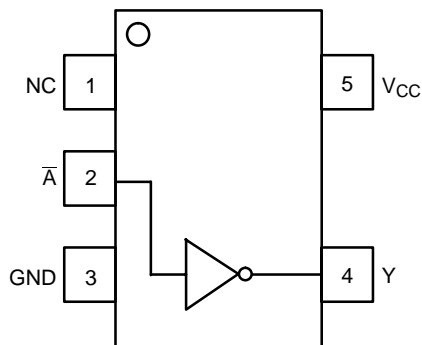

Figure 1. Pinout (Top View)

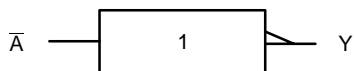

Figure 2. Logic Symbol



ON Semiconductor®

<http://onsemi.com>

MARKING DIAGRAMS

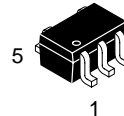

SOT-353/SC70-5/SC-88A
DF SUFFIX
CASE 419A

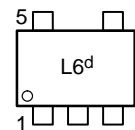

d = Date Code

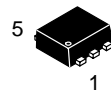

SOT-553
XV5 SUFFIX
CASE 463B

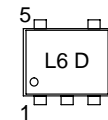

L6 = Device Marking
D = One Digit Date Code

PIN ASSIGNMENT

Pin	Function
1	NC
2	\bar{A}
3	GND
4	Y
5	V_{CC}

FUNCTION TABLE

Input	Output $Y = \bar{A}$
A	Y
L	H
H	L

ORDERING INFORMATION

See detailed ordering and shipping information in the package dimensions section on page 4 of this data sheet.

NL17SZU04

MAXIMUM RATINGS

Symbol	Parameter	Value	Unit	
V _{CC}	DC Supply Voltage	-0.5 to +7.0	V	
V _{IN}	DC Input Voltage	-0.5 to +7.0	V	
V _{OUT}	DC Output Voltage	-0.5 to +7.0	V	
I _{IK}	DC Input Diode Current	-50	mA	
I _{OK}	DC Output Diode Current	-50	mA	
I _{OUT}	DC Output Sink Current	±50	mA	
I _{CC}	DC Supply Current per Supply Pin	±100	mA	
T _{STG}	Storage Temperature Range	-65 to +150	°C	
T _L	Lead Temperature, 1 mm from Case for 10 Seconds	260	°C	
T _J	Junction Temperature Under Bias	+150	°C	
θ _{JA}	Thermal Resistance	SOT-353 (Note 1) SOT-553	350 496	°C/W
P _D	Power Dissipation in Still Air at 85°C	SOT-353 SOT-553	186 135	mW
MSL	Moisture Sensitivity	Level 1		
F _R	Flammability Rating	Oxygen Index: 28 to 34	UL 94 V-0 @ 0.125 in	
V _{ESD}	ESD Withstand Voltage	Human Body Model (Note 2) Machine Model (Note 3) Charged Device Model (Note 4)	Class IC Class A N/A	V

Maximum ratings are those values beyond which device damage can occur. Maximum ratings applied to the device are individual stress limit values (not normal operating conditions) and are not valid simultaneously. If these limits are exceeded, device functional operation is not implied, damage may occur and reliability may be affected.

1. Measured with minimum pad spacing on an FR4 board, using 10 mm-by-1 inch, 2-ounce copper trace with no air flow.
2. Tested to EIA/JESD22-A114-A, rated to EIA/JESD22-A114-B.
3. Tested to EIA/JESD22-A115-A, rated to EIA/JESD22-A115-A.
4. Tested to JESD22-C101-A.

RECOMMENDED OPERATING CONDITIONS

Symbol	Parameter	Min	Max	Unit
V _{CC}	DC Supply Voltage	(Operating) 1.65	5.5	V
		Data Retention Only 1.5	5.5	
V _{IN}	DC Input Voltage	0	5.5	V
V _{OUT}	DC Output Voltage	0	5.5	V
T _A	Operating Temperature Range	-40	+85	°C
t _r , t _f	Input Rise and Fall Time	V _{CC} = 3.0 V ± 0.3 V V _{CC} = 5.0 V ± 0.5 V	0 100	ns/V
			0 20	

NL17SZU04

DC ELECTRICAL CHARACTERISTICS

Symbol	Parameter	Condition	V _{CC} (V)	T _A = 25°C			-40°C ≤ T _A ≤ 85°C		Unit
				Min	Typ	Max	Min	Max	
V _{IH}	High-Level Input Voltage		1.65 to 1.85	0.85 V _{CC}			0.85 V _{CC}		V
			2.3 to 5.5	0.8 V _{CC}			0.8 V _{CC}		
V _{IL}	Low-Level Input Voltage		1.65 to 1.85			0.15 V _{CC}		0.15 V _{CC}	V
			2.3 to 5.5			0.2 V _{CC}		0.2 V _{CC}	
V _{OH}	High-Level Output Voltage V _{IN} = V _{IL} or V _{IH}	I _{OH} = -100 μA	1.65 to 5.5	V _{CC} - 0.1	V _{CC}		V _{CC} - 0.1		V
		I _{OH} = -3 mA	1.65	1.29	1.52		1.29		
		I _{OH} = -4 mA	2.3	1.9	2.1		1.9		
		I _{OH} = -6 mA	2.7	2.2	2.4		2.2		
		I _{OH} = -8 mA	3.0	2.4	2.7		2.4		
		I _{OH} = -12 mA	3.0	2.3	2.5		2.3		
		I _{OH} = -16 mA	4.5	3.8	4.0		3.8		
V _{OL}	Low-Level Output Voltage V _{IN} = V _{IH} or V _{OH}	I _{OL} = 100 μA	1.65 to 5.5			0.1		0.1	V
		I _{OL} = 3 mA	1.65		0.08	0.24		0.24	
		I _{OL} = 4 mA	2.3		0.20	0.3		0.3	
		I _{OL} = 6 mA	2.7		0.22	0.4		0.4	
		I _{OL} = 8 mA	3.0		0.28	0.4		0.4	
		I _{OL} = 12 mA	3.0		0.38	0.55		0.55	
		I _{OL} = 16 mA	4.5		0.42	0.55		0.55	
I _{IN}	Input Leakage Current	V _{IN} = V _{CC} or GND	0 to 5.5			±0.1		±1.0	μA
I _{OFF}	Power Off-Output Leakage Current	V _{OUT} = 5.5 V	0			1		10	μA
I _{CC}	Quiescent Supply Current	V _{IN} = V _{CC} or GND	1.65 to 5.5			1		10	μA

AC ELECTRICAL CHARACTERISTICS t_R = t_F = 3.0 ns

Symbol	Parameter	Condition	V _{CC} (V)	T _A = 25°C		-40°C ≤ T _A ≤ 85°C		Unit
				Min	Max	Min	Max	
t _{PLH} t _{PHL}	Propagation Delay (Figure 3 and 4)	R _L = 1 MΩ, C _L = 15 pF	1.8 ± 0.15	1.0	11.7	1.0	12.1	ns
		R _L = 1 MΩ, C _L = 15 pF	2.5 ± 0.2	0.8	6.2	0.8	6.5	
		R _L = 1 MΩ, C _L = 15 pF	3.3 ± 0.3	0.5	4.5	0.5	4.8	
		R _L = 500 Ω, C _L = 50 pF		1.0	6.0	1.0	6.5	
		R _L = 1 MΩ, C _L = 15 pF	5.0 ± 0.5	0.5	3.9	0.5	1.0	
		R _L = 500 Ω, C _L = 50 pF		0.8	5.0	0.8	5.5	

CAPACITIVE CHARACTERISTICS

Symbol	Parameter	Condition	Typical	Unit
C _{IN}	Input Capacitance	V _{CC} = 5.5 V, V _I = 0 V or V _{CC}	4.5	pF
C _{PD}	Power Dissipation Capacitance (Note 5)	10 MHz, V _{CC} = 3.3 V, V _I = 0 V or V _{CC}	6.5	pF
		10 MHz, V _{CC} = 5.5 V, V _I = 0 V or V _{CC}	10	

5. C_{PD} is defined as the value of the internal equivalent capacitance which is calculated from the operating current consumption without load. Average operating current can be obtained by the equation: I_{CC(OPR)} = C_{PD} • V_{CC} • f_{in} + I_{CC}. C_{PD} is used to determine the no-load dynamic power consumption; P_D = C_{PD} • V_{CC}² • f_{in} + I_{CC} • V_{CC}.

NL17SZU04

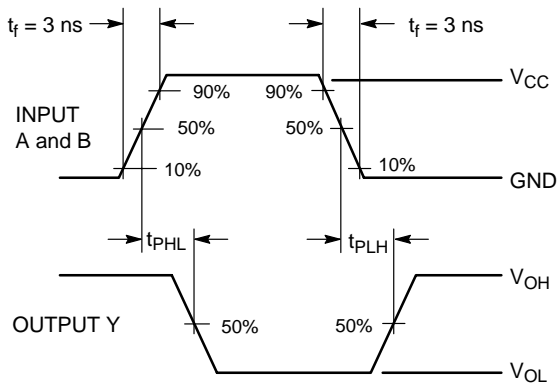
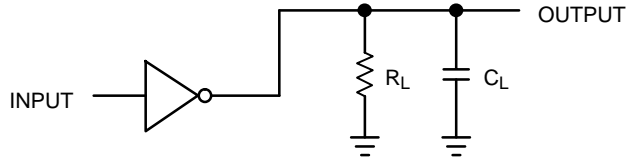

Figure 3. Switching Waveform



A 1-MHz square input wave is recommended for propagation delay tests.

Figure 4. Test Circuit

DEVICE ORDERING INFORMATION

Device Order Number	Device Nomenclature							Package Type	Tape and Reel Size†
	Logic Circuit Indicator	No. of Gates per Package	Temp Range Identifier	Technology	Device Function	Package Suffix	Tape and Reel Suffix		
NL17SZU04DFT2	NL	1	7	SZ	U04	DF	T2	SOT-353/ SC70-5/ SC-88A	178 mm, 3000 Unit
NL17SZU04DFT2G	NL	1	7	SZ	U04	DF	T2	SOT-353/ SC70-5/ SC-88A (Pb-Free)	178 mm, 3000 Unit
NL17SZU04XV5T2	NL	1	7	SZ	U04	XV5	T2	SOT-553*	178 mm, 4000 Unit

†For information on tape and reel specifications, including part orientation and tape sizes, please refer to our Tape and Reel Packaging Specifications Brochure, BRD8011/D.

*All Devices in Package SOT553 are Inherently Pb-Free.

NL17SZU04

PACKAGE DIMENSIONS

SOT-353
DF SUFFIX
5-LEAD PACKAGE
CASE 419A-02
ISSUE G

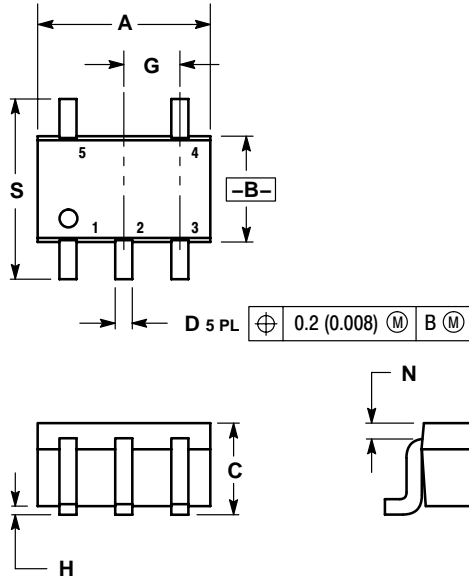

NOTES:

1. DIMENSIONING AND TOLERANCING PER ANSI Y14.5M, 1982.
2. CONTROLLING DIMENSION: INCH.
3. 419A-01 OBSOLETE. NEW STANDARD 419A-02.
4. DIMENSIONS A AND B DO NOT INCLUDE MOLD FLASH, PROTRUSIONS, OR GATE BURRS.

DIM	INCHES		MILLIMETERS	
	MIN	MAX	MIN	MAX
A	0.071	0.087	1.80	2.20
B	0.045	0.053	1.15	1.35
C	0.031	0.043	0.80	1.10
D	0.004	0.012	0.10	0.30
G	0.026 BSC		0.65 BSC	
H	---	0.004	---	0.10
J	0.004	0.010	0.10	0.25
K	0.004	0.012	0.10	0.30
N	0.008 REF		0.20 REF	
S	0.079	0.087	2.00	2.20

SOLDERING FOOTPRINT*

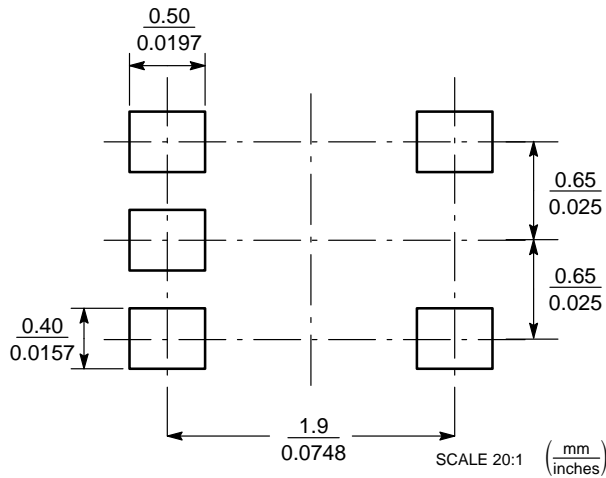

*For additional information on our Pb-Free strategy and soldering details, please download the ON Semiconductor Soldering and Mounting Techniques Reference Manual, SOLDERRM/D.

NL17SZU04

PACKAGE DIMENSIONS

SOT-553
XV5 SUFFIX
5-LEAD PACKAGE
CASE 463B-01
ISSUE A

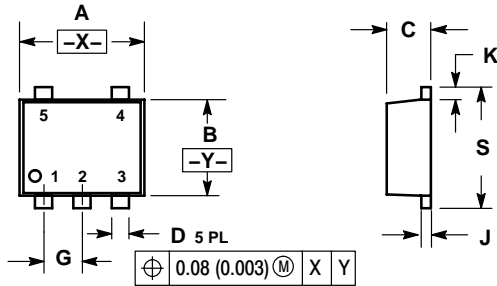

NOTES:

1. DIMENSIONING AND TOLERANCING PER ANSI Y14.5M, 1982.
2. CONTROLLING DIMENSION: MILLIMETERS
3. MAXIMUM LEAD THICKNESS INCLUDES LEAD FINISH THICKNESS. MINIMUM LEAD THICKNESS IS THE MINIMUM THICKNESS OF BASE MATERIAL.

DIM	MILLIMETERS		INCHES	
	MIN	MAX	MIN	MAX
A	1.50	1.70	0.059	0.067
B	1.10	1.30	0.043	0.051
C	0.50	0.60	0.020	0.024
D	0.17	0.27	0.007	0.011
G	0.50 BSC		0.020 BSC	
J	0.08	0.18	0.003	0.007
K	0.10	0.30	0.004	0.012
S	1.50	1.70	0.059	0.067

STYLE 1:

- PIN 1. BASE 1
- EMITTER 1/2
- BASE 2
- COLLECTOR 2
- COLLECTOR 1

STYLE 2:

- PIN 1. CATHODE
- ANODE
- CATHODE
- CATHODE
- CATHODE

SOLDERING FOOTPRINT*

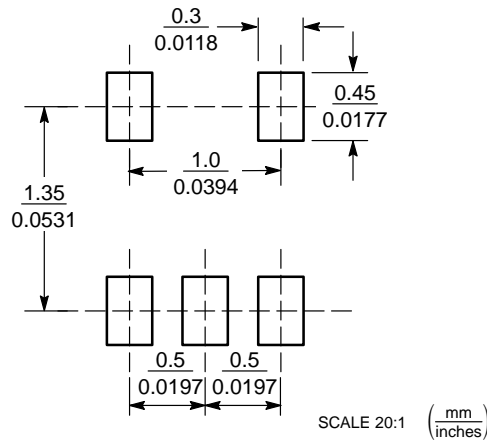

*For additional information on our Pb-Free strategy and soldering details, please download the ON Semiconductor Soldering and Mounting Techniques Reference Manual, SOLDERRM/D.

ON Semiconductor and are registered trademarks of Semiconductor Components Industries, LLC (SCILLC). SCILLC reserves the right to make changes without further notice to any products herein. SCILLC makes no warranty, representation or guarantee regarding the suitability of its products for any particular purpose, nor does SCILLC assume any liability arising out of the application or use of any product or circuit, and specifically disclaims any and all liability, including without limitation special, consequential or incidental damages. "Typical" parameters which may be provided in SCILLC data sheets and/or specifications can and do vary in different applications and actual performance may vary over time. All operating parameters, including "Typicals" must be validated for each customer application by customer's technical experts. SCILLC does not convey any license under its patent rights nor the rights of others. SCILLC products are not designed, intended, or authorized for use as components in systems intended for surgical implant into the body, or other applications intended to support or sustain life, or for any other application in which the failure of the SCILLC product could create a situation where personal injury or death may occur. Should Buyer purchase or use SCILLC products for any such unintended or unauthorized application, Buyer shall indemnify and hold SCILLC and its officers, employees, subsidiaries, affiliates, and distributors harmless against all claims, costs, damages, and expenses, and reasonable attorney fees arising out of, directly or indirectly, any claim of personal injury or death associated with such unintended or unauthorized use, even if such claim alleges that SCILLC was negligent regarding the design or manufacture of the part. SCILLC is an Equal Opportunity/Affirmative Action Employer. This literature is subject to all applicable copyright laws and is not for resale in any manner.

PUBLICATION ORDERING INFORMATION

LITERATURE FULFILLMENT:

Literature Distribution Center for ON Semiconductor
 P.O. Box 61312, Phoenix, Arizona 85082-1312 USA
Phone: 480-829-7710 or 800-344-3860 Toll Free USA/Canada
Fax: 480-829-7709 or 800-344-3867 Toll Free USA/Canada
Email: orderlit@onsemi.com

N. American Technical Support: 800-282-9855 Toll Free USA/Canada

Japan: ON Semiconductor, Japan Customer Focus Center
 2-9-1 Kamimeguro, Meguro-ku, Tokyo, Japan 153-0051
Phone: 81-3-5773-3850

ON Semiconductor Website: <http://onsemi.com>

Order Literature: <http://www.onsemi.com/litorder>

For additional information, please contact your local Sales Representative.