

# BCW32LT1

## General Purpose Transistors

### NPN Silicon

#### Features

- Pb-Free Package is Available

#### MAXIMUM RATINGS

Rating	Symbol	Value	Unit
Collector-Emitter Voltage	$V_{CEO}$	32	Vdc
Collector-Base Voltage	$V_{CBO}$	32	Vdc
Emitter-Base Voltage	$V_{EBO}$	5.0	Vdc
Collector Current – Continuous	$I_C$	100	mAdc

Maximum ratings are those values beyond which device damage can occur. Maximum ratings applied to the device are individual stress limit values (not normal operating conditions) and are not valid simultaneously. If these limits are exceeded, device functional operation is not implied, damage may occur and reliability may be affected.

#### THERMAL CHARACTERISTICS

Characteristic	Symbol	Value	Unit
Total Device Dissipation FR-5 Board <sup>(1)</sup> $T_A = 25^\circ\text{C}$ Derate above $25^\circ\text{C}$	$P_D$	225	mW
		1.8	mW/ $^\circ\text{C}$
Thermal Resistance, Junction-to-Ambient	$R_{\theta JA}$	556	$^\circ\text{C}/\text{W}$
Total Device Dissipation Alumina Substrate, <sup>(2)</sup> $T_A = 25^\circ\text{C}$ Derate above $25^\circ\text{C}$	$P_D$	300	mW
		2.4	mW/ $^\circ\text{C}$
Thermal Resistance, Junction-to-Ambient	$R_{\theta JA}$	417	$^\circ\text{C}/\text{W}$
Junction and Storage Temperature	$T_J, T_{stg}$	-55 to +150	$^\circ\text{C}$

- FR-5 =  $1.0 \times 0.75 \times 0.062$  in.
- Alumina =  $0.4 \times 0.3 \times 0.024$  in. 99.5% alumina.



ON Semiconductor®

<http://onsemi.com>

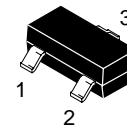
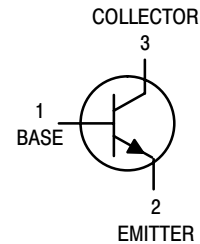

SOT-23 (TO-236AB)  
CASE 318  
STYLE 6

#### MARKING DIAGRAM

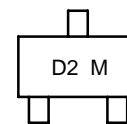

M = Date Code

#### ORDERING INFORMATION

Device	Package	Shipping†
BCW32LT1	SOT-23	3000 Units / Reel
BCW32LT1G	SOT-23 (Pb-Free)	3000 Units / Reel

†For information on tape and reel specifications, including part orientation and tape sizes, please refer to our Tape and Reel Packaging Specifications Brochure, BRD8011/D.

# BCW32LT1

## ELECTRICAL CHARACTERISTICS ( $T_A = 25^\circ\text{C}$ unless otherwise noted)

Characteristic	Symbol	Min	Typ	Max	Unit
<b>OFF CHARACTERISTICS</b>					
Collector–Emitter Breakdown Voltage ( $I_C = 2.0\text{ mA}$ , $V_{EB} = 0$ )	$V_{(BR)CEO}$	32	–	–	Vdc
Collector–Base Breakdown Voltage ( $I_C = 10\text{ }\mu\text{A}$ , $I_E = 0$ )	$V_{(BR)CBO}$	32	–	–	Vdc
Emitter–Base Breakdown Voltage ( $I_E = 10\text{ }\mu\text{A}$ , $I_C = 0$ )	$V_{(BR)EBO}$	5.0	–	–	Vdc
Collector Cutoff Current ( $V_{CB} = 32\text{ Vdc}$ , $I_E = 0$ ) ( $V_{CB} = 32\text{ Vdc}$ , $I_E = 0$ , $T_A = 100^\circ\text{C}$ )	$I_{CBO}$	– –	– –	100 10	nA $\mu\text{A}$
<b>ON CHARACTERISTICS</b>					
DC Current Gain ( $I_C = 2.0\text{ mA}$ , $V_{CE} = 5.0\text{ Vdc}$ )	$h_{FE}$	200	–	450	–
Collector–Emitter Saturation Voltage ( $I_C = 10\text{ mA}$ , $I_B = 0.5\text{ mA}$ )	$V_{CE(sat)}$	–	–	0.25	Vdc
Base–Emitter On Voltage ( $I_C = 2.0\text{ mA}$ , $V_{CE} = 5.0\text{ Vdc}$ )	$V_{BE(on)}$	0.55	–	0.70	Vdc
<b>SMALL–SIGNAL CHARACTERISTICS</b>					
Output Capacitance ( $I_E = 0$ , $V_{CB} = 10\text{ Vdc}$ , $f = 1.0\text{ MHz}$ )	$C_{obo}$	–	–	4.0	pF
Noise Figure ( $I_C = 0.2\text{ mA}$ , $V_{CE} = 5.0\text{ Vdc}$ , $R_S = 2.0\text{ k}\Omega$ , $f = 1.0\text{ kHz}$ , $BW = 200\text{ Hz}$ )	NF	–	–	10	dB

## TYPICAL NOISE CHARACTERISTICS

( $V_{CE} = 5.0\text{ Vdc}$ ,  $T_A = 25^\circ\text{C}$ )

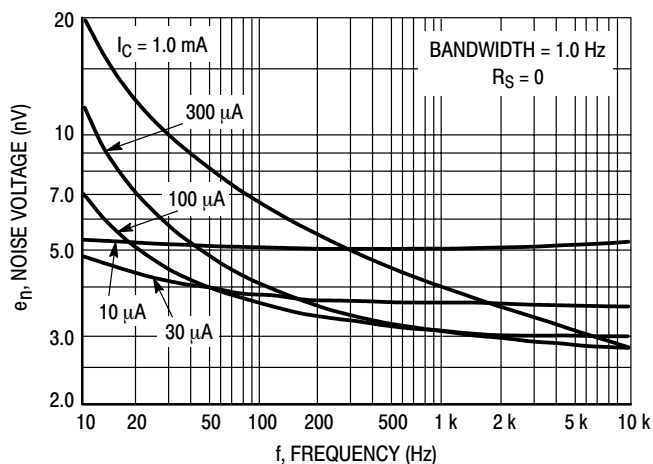

Figure 1. Noise Voltage

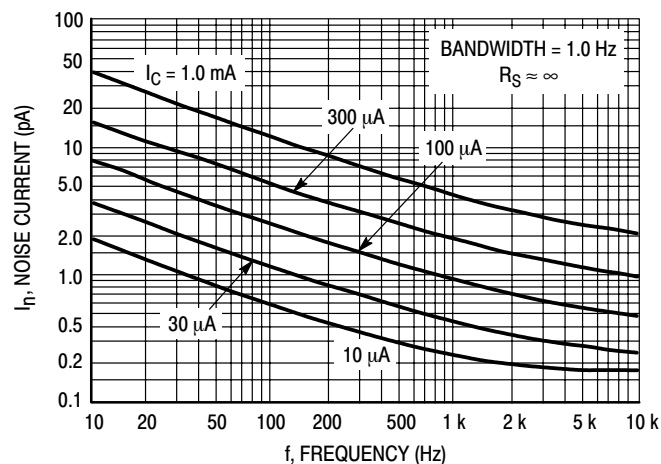

Figure 2. Noise Current

# BCW32LT1

## NOISE FIGURE CONTOURS

( $V_{CE} = 5.0 \text{ Vdc}$ ,  $T_A = 25^\circ\text{C}$ )

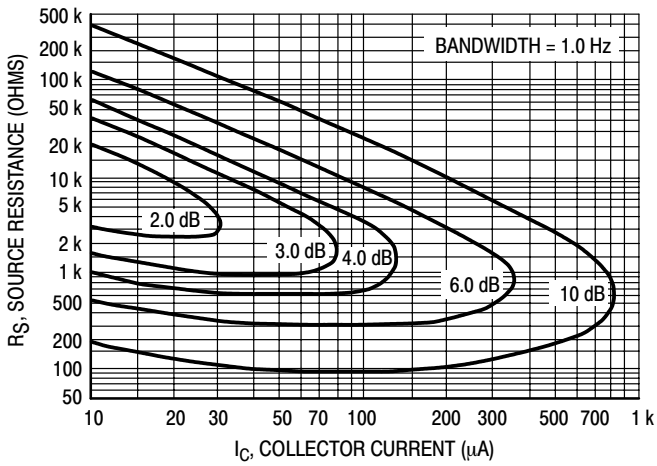

Figure 3. Narrow Band, 100 Hz

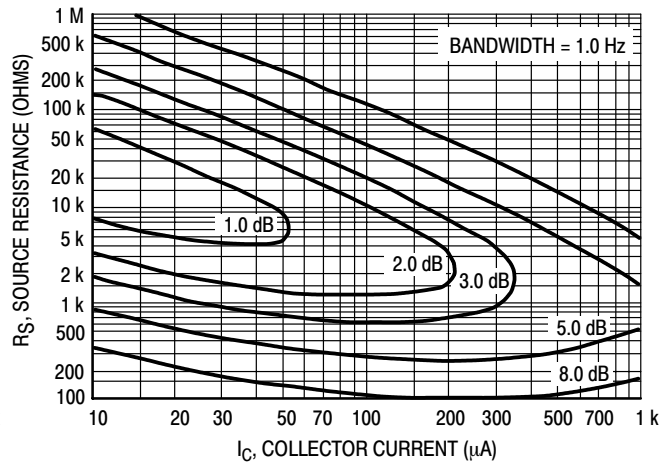

Figure 4. Narrow Band, 1.0 kHz

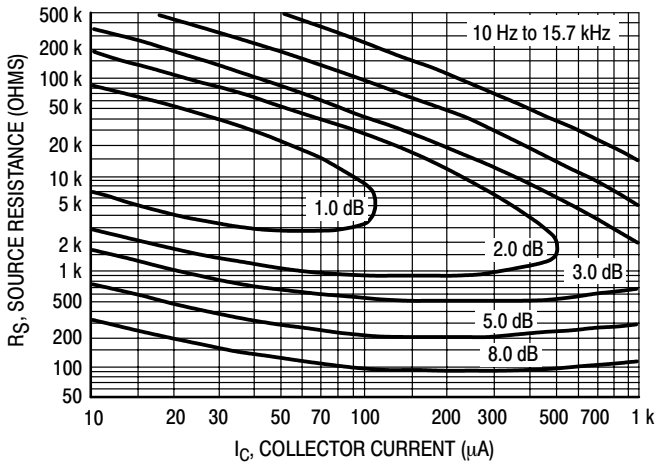

Figure 5. Wideband

Noise Figure is defined as:

$$NF = 20 \log_{10} \left( \frac{e_n^2 + 4KTR_S + I_n^2 R_S^2}{4KTR_S} \right)^{1/2}$$

$e_n$  = Noise Voltage of the Transistor referred to the input. (Figure 3)

$I_n$  = Noise Current of the Transistor referred to the input.

$n$  (Figure 4)

$K$  = Boltzman's Constant ( $1.38 \times 10^{-23} \text{ J/}^\circ\text{K}$ )

$T$  = Temperature of the Source Resistance ( $^\circ\text{K}$ )

$R$  = Source Resistance ( $\Omega$ )

$S$

# BCW32LT1

## TYPICAL STATIC CHARACTERISTICS

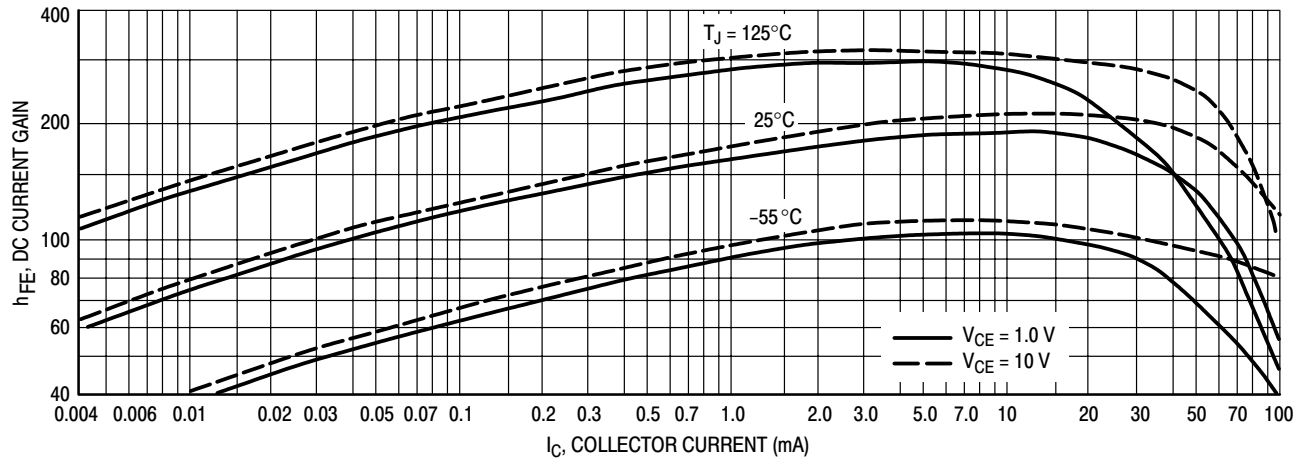

Figure 6. DC Current Gain

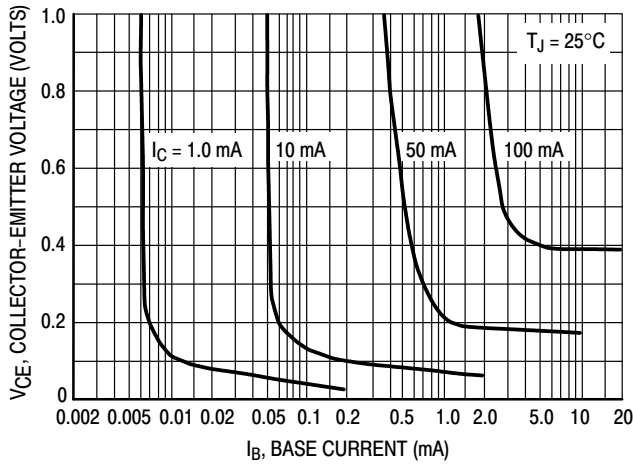

Figure 7. Collector Saturation Region

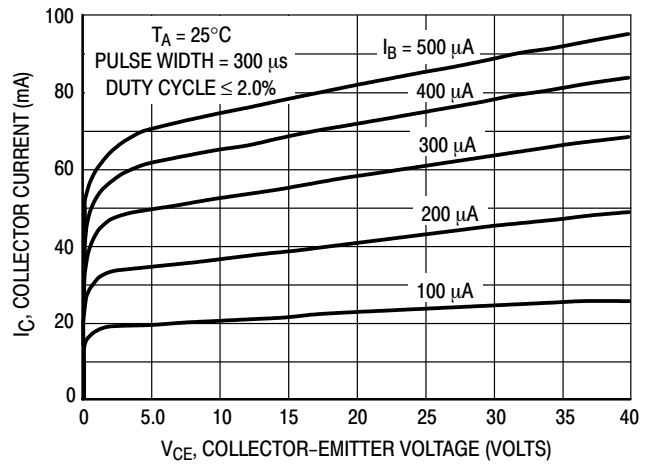

Figure 8. Collector Characteristics

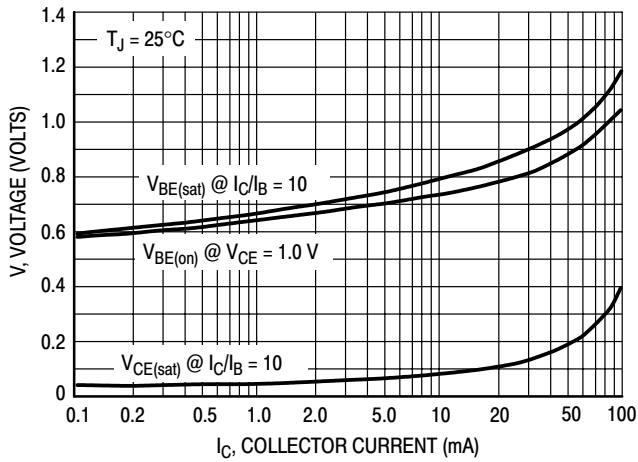

Figure 9. "On" Voltages

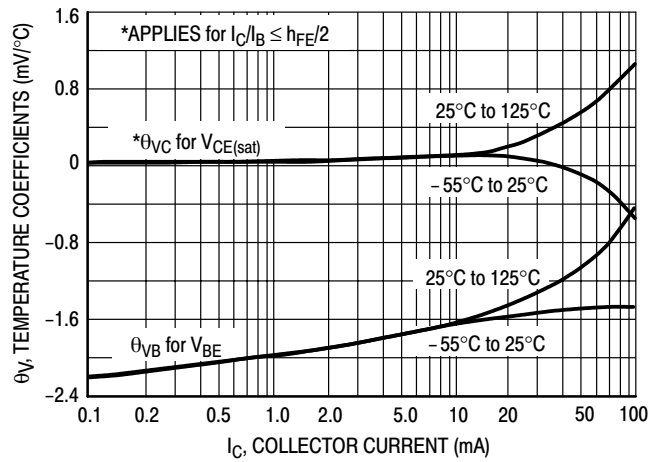

Figure 10. Temperature Coefficients

# BCW32LT1

## TYPICAL DYNAMIC CHARACTERISTICS

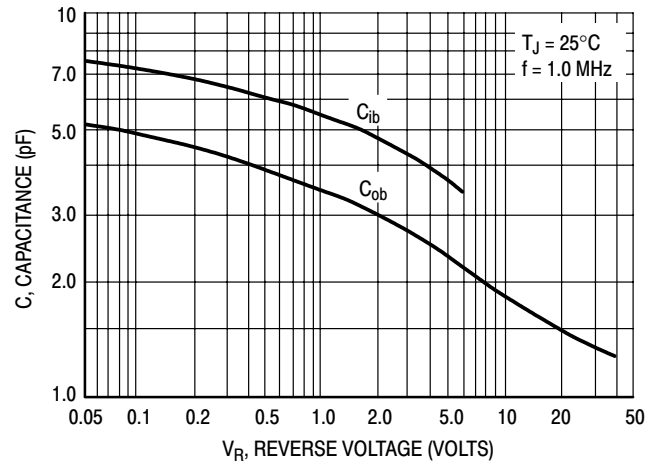
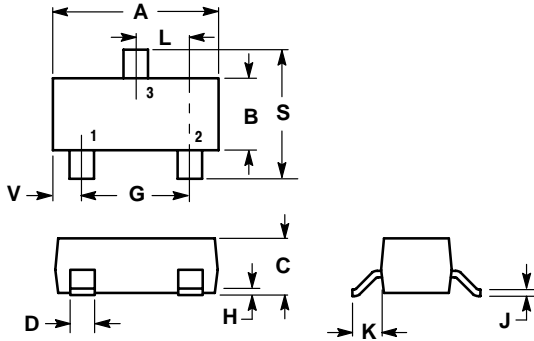

Figure 11. Capacitance

# BCW32LT1

## PACKAGE DIMENSIONS

### SOT-23 (TO-236AB) CASE 318-08 ISSUE AK



#### NOTES:

1. DIMENSIONING AND TOLERANCING PER ANSI Y14.5M, 1982.
2. CONTROLLING DIMENSION: INCH.
3. MAXIMUM LEAD THICKNESS INCLUDES LEAD FINISH THICKNESS. MINIMUM LEAD THICKNESS IS THE MINIMUM THICKNESS OF BASE MATERIAL.
4. 318-01 THRU -07 AND -09 OBSOLETE, NEW STANDARD 318-08.

DIM	INCHES		MILLIMETERS	
	MIN	MAX	MIN	MAX
A	0.1102	0.1197	2.80	3.04
B	0.0472	0.0551	1.20	1.40
C	0.0350	0.0440	0.89	1.11
D	0.0150	0.0200	0.37	0.50
G	0.0701	0.0807	1.78	2.04
H	0.0005	0.0040	0.013	0.100
J	0.0034	0.0070	0.085	0.177
K	0.0140	0.0285	0.35	0.69
L	0.0350	0.0401	0.89	1.02
S	0.0830	0.1039	2.10	2.64
V	0.0177	0.0236	0.45	0.60

#### STYLE 6:

1. BASE
2. EMITTER
3. COLLECTOR

#### SOLDERING FOOTPRINT\*

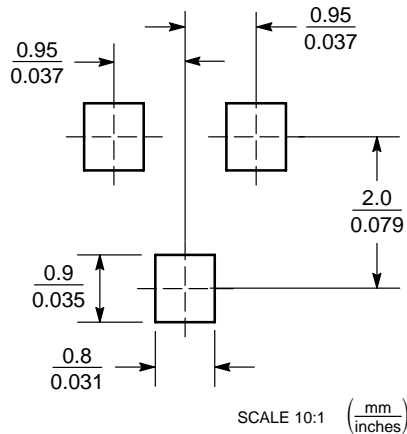

\*For additional information on our Pb-Free strategy and soldering details, please download the ON Semiconductor Soldering and Mounting Techniques Reference Manual, SOLDERRM/D.

ON Semiconductor and  are registered trademarks of Semiconductor Components Industries, LLC (SCILLC). SCILLC reserves the right to make changes without further notice to any products herein. SCILLC makes no warranty, representation or guarantee regarding the suitability of its products for any particular purpose, nor does SCILLC assume any liability arising out of the application or use of any product or circuit, and specifically disclaims any and all liability, including without limitation special, consequential or incidental damages. "Typical" parameters which may be provided in SCILLC data sheets and/or specifications can and do vary in different applications and actual performance may vary over time. All operating parameters, including "Typicals" must be validated for each customer application by customer's technical experts. SCILLC does not convey any license under its patent rights nor the rights of others. SCILLC products are not designed, intended, or authorized for use as components in systems intended for surgical implant into the body, or other applications intended to support or sustain life, or for any other application in which the failure of the SCILLC product could create a situation where personal injury or death may occur. Should Buyer purchase or use SCILLC products for any such unintended or unauthorized application, Buyer shall indemnify and hold SCILLC and its officers, employees, subsidiaries, affiliates, and distributors harmless against all claims, costs, damages, and expenses, and reasonable attorney fees arising out of, directly or indirectly, any claim of personal injury or death associated with such unintended or unauthorized use, even if such claim alleges that SCILLC was negligent regarding the design or manufacture of the part. SCILLC is an Equal Opportunity/Affirmative Action Employer. This literature is subject to all applicable copyright laws and is not for resale in any manner.

#### PUBLICATION ORDERING INFORMATION

##### LITERATURE FULFILLMENT:

Literature Distribution Center for ON Semiconductor  
P.O. Box 61312, Phoenix, Arizona 85082-1312 USA  
Phone: 480-829-7710 or 800-344-3860 Toll Free USA/Canada  
Fax: 480-829-7709 or 800-344-3867 Toll Free USA/Canada  
Email: orderlit@onsemi.com

N. American Technical Support: 800-282-9855 Toll Free  
USA/Canada

Japan: ON Semiconductor, Japan Customer Focus Center  
2-9-1 Kamimeguro, Meguro-ku, Tokyo, Japan 153-0051  
Phone: 81-3-5773-3850

ON Semiconductor Website: <http://onsemi.com>

Order Literature: <http://www.onsemi.com/litorder>

For additional information, please contact your local Sales Representative.