

MMBD2837LT1, MMBD2838LT1

Monolithic Dual Switching Diodes

Features

- Pb-Free Packages are Available

MAXIMUM RATINGS (EACH DIODE)

Rating	Symbol	Value	Unit
Peak Reverse Voltage	V_{RM}	75	Vdc
D.C. Reverse Voltage	V_R	30 50	Vdc
Peak Forward Current	I_{FM}	450 300	mAdc
Average Rectified Current	I_O	150 100	mAdc

Maximum ratings are those values beyond which device damage can occur. Maximum ratings applied to the device are individual stress limit values (not normal operating conditions) and are not valid simultaneously. If these limits are exceeded, device functional operation is not implied, damage may occur and reliability may be affected.

THERMAL CHARACTERISTICS

Rating	Symbol	Value	Unit
Total Device Dissipation FR-5 Board (Note 1) $T_A = 25^\circ\text{C}$ Derate above 25°C	P_D	225 1.8	mW mW/ $^\circ\text{C}$
Thermal Resistance, Junction-to-Ambient	$R_{\theta JA}$	556	$^\circ\text{C}/\text{W}$
Total Device Dissipation Alumina Substrate, (Note 2) $T_A = 25^\circ\text{C}$ Derate above 25°C	P_D	300 2.4	mW mW/ $^\circ\text{C}$
Thermal Resistance, Junction-to-Ambient	$R_{\theta JA}$	417	$^\circ\text{C}/\text{W}$
Junction and Storage Temperature	T_J, T_{stg}	-55 to +150	$^\circ\text{C}$

- FR-5 = $1.0 \times 0.75 \times 0.062$ in.
- Alumina = $0.4 \times 0.3 \times 0.024$ in. 99.5% alumina.



ON Semiconductor®

<http://onsemi.com>

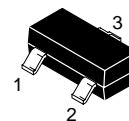
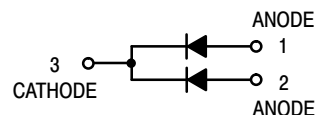

SOT-23 (TO-236AB)
CASE 318
STYLE 9

MARKING DIAGRAM

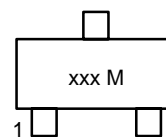

xxx = Specific Device Code
MMBD2837LT1 – A5
MMBD2838LT1 – MA6
M = Date Code

ORDERING INFORMATION

Device	Package	Shipping†
MMBD2837LT1	SOT-23	3000 Tape & Reel
MMBD2837LT1G	SOT-23 (Pb-Free)	3000 Tape & Reel
MMBD2838LT1	SOT-23	3000 Tape & Reel
MMBD2838LT1G	SOT-23 (Pb-Free)	3000 Tape & Reel

†For information on tape and reel specifications, including part orientation and tape sizes, please refer to our Tape and Reel Packaging Specifications Brochure, BRD8011/D.

MMBD2837LT1, MMBD2838LT1

ELECTRICAL CHARACTERISTICS (EACH DIODE) ($T_A = 25^\circ\text{C}$ unless otherwise noted)

Characteristic		Symbol	Min	Max	Unit
OFF CHARACTERISTICS					
Reverse Breakdown Voltage ($I_{(BR)} = 100 \mu\text{A}$)	MMBD2837LT1 MMBD2838LT1	$V_{(BR)}$	35 75	- -	Vdc
Reverse Voltage Leakage Current (Note 3.) ($V_R = 30 \text{ Vdc}$) ($V_R = 50 \text{ Vdc}$)	MMBD2837LT1 MMBD2838LT1	I_R	- -	0.1 0.1	μA
Diode Capacitance ($V_R = 0 \text{ V}$, $f = 1.0 \text{ MHz}$)		C_T	-	4.0	pF
Forward Voltage ($I_F = 10 \text{ mA}$) ($I_F = 50 \text{ mA}$) ($I_F = 100 \text{ mA}$)		V_F	- - -	1.0 1.0 1.2	Vdc
Reverse Recovery Time ($I_F = I_R = 10 \text{ mA}$, $I_{R(REC)} = 1.0 \text{ mA}$) (Figure 1)		t_{rr}	-	4.0	ns

3. For each individual diode while the second diode is unbiased.

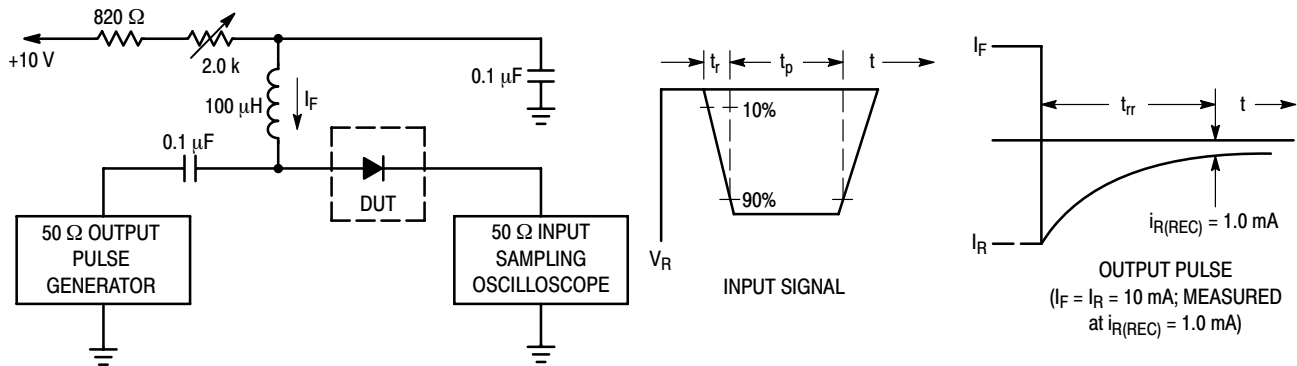

- Notes: 1. A 2.0 k Ω variable resistor adjusted for a Forward Current (I_F) of 10 mA.
 Notes: 2. Input pulse is adjusted so $I_{R(\text{peak})}$ is equal to 10 mA.
 Notes: 3. $t_p \gg t_{rr}$

Figure 1. Recovery Time Equivalent Test Circuit

MMBD2837LT1, MMBD2838LT1

CURVES APPLICABLE TO EACH CATHODE

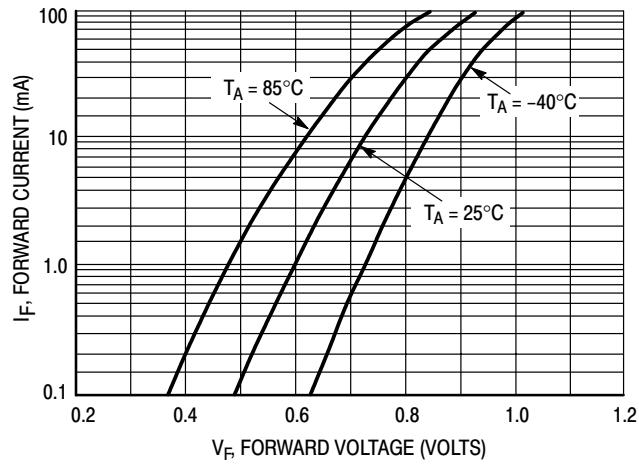

Figure 2. Forward Voltage

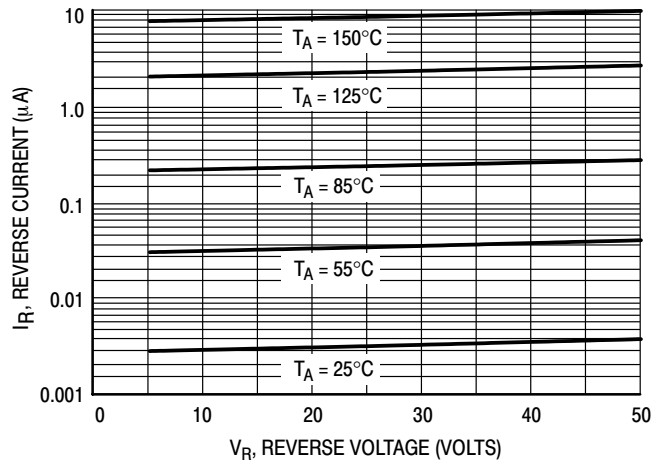

Figure 3. Leakage Current

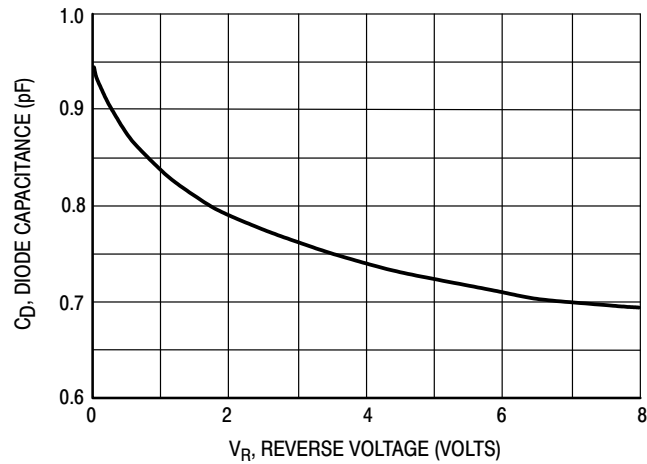

Figure 4. Capacitance

MMBD2837LT1, MMBD2838LT1

PACKAGE DIMENSIONS

SOT-23 (TO236)

CASE 318-18

ISSUE AK

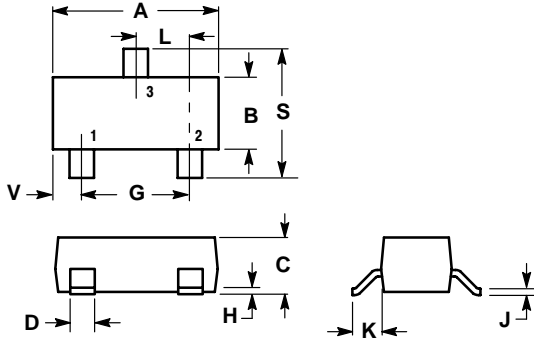

NOTES:

1. DIMENSIONING AND TOLERANCING PER ANSI Y14.5M, 1982.
2. CONTROLLING DIMENSION: INCH.
3. MAXIMUM LEAD THICKNESS INCLUDES LEAD FINISH THICKNESS. MINIMUM LEAD THICKNESS IS THE MINIMUM THICKNESS OF BASE MATERIAL.
4. 318-01 THRU -07 AND -09 OBSOLETE, NEW STANDARD 318-08.

DIM	INCHES		MILLIMETERS	
	MIN	MAX	MIN	MAX
A	0.1102	0.1197	2.80	3.04
B	0.0472	0.0551	1.20	1.40
C	0.0350	0.0440	0.89	1.11
D	0.0150	0.0200	0.37	0.50
G	0.0701	0.0807	1.78	2.04
H	0.0005	0.0040	0.013	0.100
J	0.0034	0.0070	0.085	0.177
K	0.0140	0.0285	0.35	0.69
L	0.0350	0.0401	0.89	1.02
S	0.0830	0.1039	2.10	2.64
V	0.0177	0.0236	0.45	0.60

STYLE 9:

1. ANODE
2. ANODE
3. CATHODE

SOLDERING FOOTPRINT*

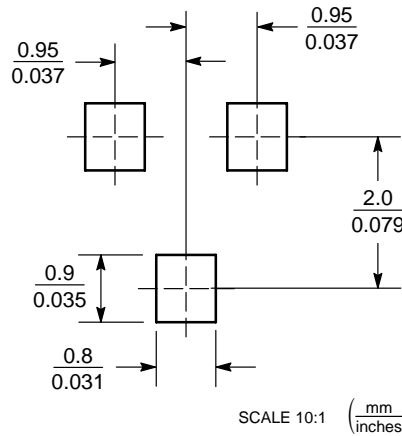

*For additional information on our Pb-Free strategy and soldering details, please download the ON Semiconductor Soldering and Mounting Techniques Reference Manual, SOLDERRM/D.

ON Semiconductor and are registered trademarks of Semiconductor Components Industries, LLC (SCILLC). SCILLC reserves the right to make changes without further notice to any products herein. SCILLC makes no warranty, representation or guarantee regarding the suitability of its products for any particular purpose, nor does SCILLC assume any liability arising out of the application or use of any product or circuit, and specifically disclaims any and all liability, including without limitation special, consequential or incidental damages. "Typical" parameters which may be provided in SCILLC data sheets and/or specifications can and do vary in different applications and actual performance may vary over time. All operating parameters, including "Typicals" must be validated for each customer application by customer's technical experts. SCILLC does not convey any license under its patent rights nor the rights of others. SCILLC products are not designed, intended, or authorized for use as components in systems intended for surgical implant into the body, or other applications intended to support or sustain life, or for any other application in which the failure of the SCILLC product could create a situation where personal injury or death may occur. Should Buyer purchase or use SCILLC products for any such unintended or unauthorized application, Buyer shall indemnify and hold SCILLC and its officers, employees, subsidiaries, affiliates, and distributors harmless against all claims, costs, damages, and expenses, and reasonable attorney fees arising out of, directly or indirectly, any claim of personal injury or death associated with such unintended or unauthorized use, even if such claim alleges that SCILLC was negligent regarding the design or manufacture of the part. SCILLC is an Equal Opportunity/Affirmative Action Employer. This literature is subject to all applicable copyright laws and is not for resale in any manner.

PUBLICATION ORDERING INFORMATION

LITERATURE FULFILLMENT:

Literature Distribution Center for ON Semiconductor
P.O. Box 61312, Phoenix, Arizona 85082-1312 USA

Phone: 480-829-7710 or 800-344-3860 Toll Free USA/Canada

Fax: 480-829-7709 or 800-344-3867 Toll Free USA/Canada

Email: orderlit@onsemi.com

N. American Technical Support: 800-282-9855 Toll Free
USA/Canada

Japan: ON Semiconductor, Japan Customer Focus Center

2-9-1 Kamimeguro, Meguro-ku, Tokyo, Japan 153-0051

Phone: 81-3-5773-3850

ON Semiconductor Website: <http://onsemi.com>

Order Literature: <http://www.onsemi.com/litorder>

For additional information, please contact your local Sales Representative.

MMBD2837LT1/D