

# MMBT4403WT1

## Switching Transistor

### PNP Silicon

#### Features

- Moisture Sensitivity Level: 1
- ESD Rating: Human Body Model; 4 kV,  
Machine Model; 400 V
- Pb-Free Package is Available

#### MAXIMUM RATINGS

Rating	Symbol	Value	Unit
Collector-Emitter Voltage	$V_{CEO}$	-40	Vdc
Collector-Base Voltage	$V_{CBO}$	-40	Vdc
Emitter-Base Voltage	$V_{EBO}$	-5.0	Vdc
Collector Current - Continuous	$I_C$	-600	mAdc

#### THERMAL CHARACTERISTICS

Characteristic	Symbol	Max	Unit
Total Device Dissipation FR-5 Board $T_A = 25^\circ\text{C}$	$P_D$	150	mW
Thermal Resistance, Junction-to-Ambient	$R_{\theta JA}$	833	$^\circ\text{C/W}$
Junction and Storage Temperature	$T_J, T_{stg}$	-55 to +150	$^\circ\text{C}$

Maximum ratings are those values beyond which device damage can occur. Maximum ratings applied to the device are individual stress limit values (not normal operating conditions) and are not valid simultaneously. If these limits are exceeded, device functional operation is not implied, damage may occur and reliability may be affected.



ON Semiconductor®

<http://onsemi.com>

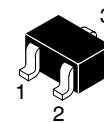
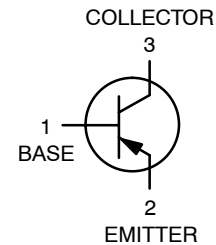

SC-70  
CASE 419  
STYLE 3

#### MARKING DIAGRAM

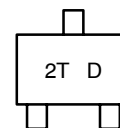

2T = Specific Device Code  
D = Date Code

#### ORDERING INFORMATION

Device	Package	Shipping†
MMBT4403WT1	SC-70	3000/Tape & Reel
MMBT4403WT1G	SC-70 (Pb-Free)	3000/Tape & Reel

†For information on tape and reel specifications, including part orientation and tape sizes, please refer to our Tape and Reel Packaging Specifications Brochure, BRD8011/D.

# MMBT4403WT1

## ELECTRICAL CHARACTERISTICS ( $T_A = 25^\circ\text{C}$ unless otherwise noted)

Characteristic	Symbol	Min	Max	Unit
<b>OFF CHARACTERISTICS</b>				
Collector-Emitter Breakdown Voltage (Note 1) ( $I_C = -1.0\text{ mAdc}$ , $I_B = 0$ )	$V_{(BR)CEO}$	-40	-	Vdc
Collector-Base Breakdown Voltage ( $I_C = -0.1\text{ mAdc}$ , $I_E = 0$ )	$V_{(BR)CBO}$	-40	-	Vdc
Emitter-Base Breakdown Voltage ( $I_E = -0.1\text{ mAdc}$ , $I_C = 0$ )	$V_{(BR)EBO}$	-5.0	-	Vdc
Base Cutoff Current ( $V_{CE} = -35\text{ Vdc}$ , $V_{EB} = -0.4\text{ Vdc}$ )	$I_{BEV}$	-	-0.1	$\mu\text{Adc}$
Collector Cutoff Current ( $V_{CE} = -35\text{ Vdc}$ , $V_{EB} = -0.4\text{ Vdc}$ )	$I_{CEX}$	-	-0.1	$\mu\text{Adc}$

## ON CHARACTERISTICS

DC Current Gain ( $I_C = -0.1\text{ mAdc}$ , $V_{CE} = -1.0\text{ Vdc}$ ) ( $I_C = -1.0\text{ mAdc}$ , $V_{CE} = -1.0\text{ Vdc}$ ) ( $I_C = -10\text{ mAdc}$ , $V_{CE} = -1.0\text{ Vdc}$ ) ( $I_C = -150\text{ mAdc}$ , $V_{CE} = -2.0\text{ Vdc}$ ) (Note 1) ( $I_C = -500\text{ mAdc}$ , $V_{CE} = -2.0\text{ Vdc}$ ) (Note 1)	$h_{FE}$	30 60 100 100 20	- - - 300 -	-
Collector-Emitter Saturation Voltage (Note 1) ( $I_C = -150\text{ mAdc}$ , $I_B = -15\text{ mAdc}$ ) ( $I_C = -500\text{ mAdc}$ , $I_B = -50\text{ mAdc}$ )	$V_{CE(sat)}$	- -	-0.4 -0.75	Vdc
Base-Emitter Saturation Voltage (Note 1) ( $I_C = -150\text{ mAdc}$ , $I_B = -15\text{ mAdc}$ ) ( $I_C = -500\text{ mAdc}$ , $I_B = -50\text{ mAdc}$ )	$V_{BE(sat)}$	-0.75 -	-0.95 -1.3	Vdc

## SMALL-SIGNAL CHARACTERISTICS

Current-Gain-Bandwidth Product ( $I_C = -20\text{ mAdc}$ , $V_{CE} = -10\text{ Vdc}$ , $f = 100\text{ MHz}$ )	$f_T$	200	-	MHz
Collector-Base Capacitance ( $V_{CB} = -10\text{ Vdc}$ , $I_E = 0$ , $f = 1.0\text{ MHz}$ )	$C_{cb}$	-	8.5	pF
Emitter-Base Capacitance ( $V_{BE} = -0.5\text{ Vdc}$ , $I_C = 0$ , $f = 1.0\text{ MHz}$ )	$C_{eb}$	-	30	pF
Input Impedance ( $I_C = -1.0\text{ mAdc}$ , $V_{CE} = -10\text{ Vdc}$ , $f = 1.0\text{ kHz}$ )	$h_{ie}$	1.5	15	k $\Omega$
Voltage Feedback Ratio ( $I_C = -1.0\text{ mAdc}$ , $V_{CE} = -10\text{ Vdc}$ , $f = 1.0\text{ kHz}$ )	$h_{re}$	0.1	8.0	$\times 10^{-4}$
Small-Signal Current Gain ( $I_C = -1.0\text{ mAdc}$ , $V_{CE} = -10\text{ Vdc}$ , $f = 1.0\text{ kHz}$ )	$h_{fe}$	60	500	-
Output Admittance ( $I_C = -1.0\text{ mAdc}$ , $V_{CE} = -10\text{ Vdc}$ , $f = 1.0\text{ kHz}$ )	$h_{oe}$	1.0	100	$\mu\text{mhos}$

## SWITCHING CHARACTERISTICS

Delay Time	$(V_{CC} = -30\text{ Vdc}$ , $V_{EB} = -2.0\text{ Vdc}$ , $I_C = -150\text{ mAdc}$ , $I_{B1} = -15\text{ mAdc}$ )	$t_d$	-	15	ns
Rise Time		$t_r$	-	20	
Storage Time	$(V_{CC} = -30\text{ Vdc}$ , $I_C = -150\text{ mAdc}$ , $I_{B1} = I_{B2} = -15\text{ mAdc}$ )	$t_s$	-	225	ns
Fall Time		$t_f$	-	30	

1. Pulse Test: Pulse Width  $\leq 300\ \mu\text{s}$ , Duty Cycle  $\leq 2.0\%$ .

## SWITCHING TIME EQUIVALENT TEST CIRCUIT

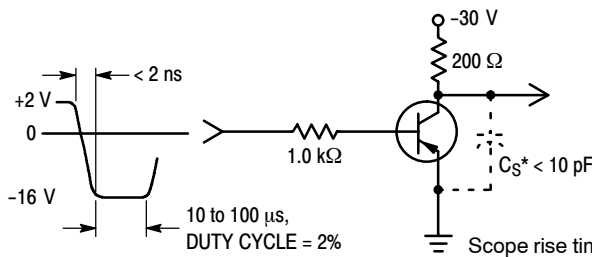

Figure 1. Turn-On Time

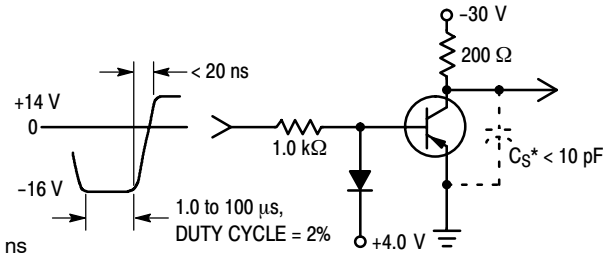

Figure 2. Turn-Off Time

# MMBT4403WT1

## TRANSIENT CHARACTERISTICS

— 25°C    - - - 100°C

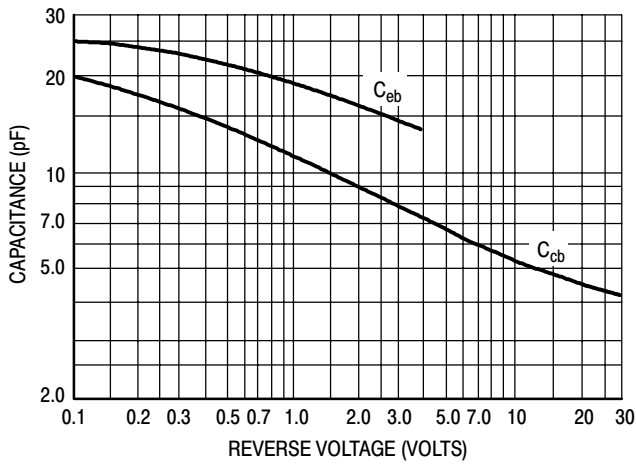

Figure 3. Capacitances

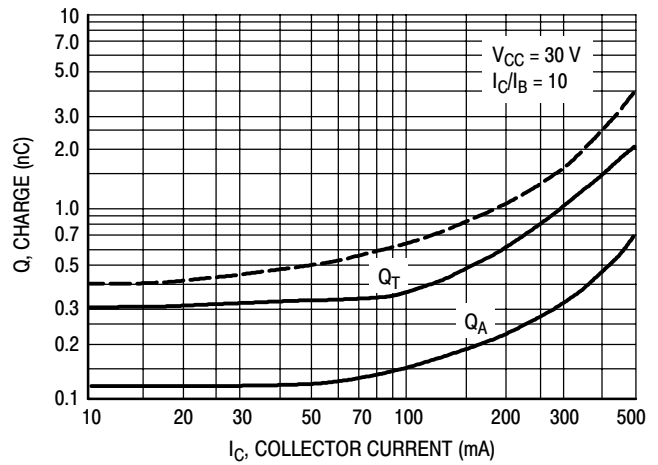

Figure 4. Charge Data

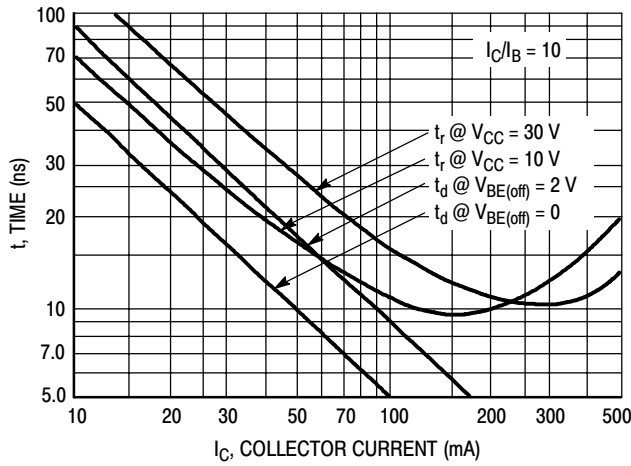

Figure 5. Turn-On Time

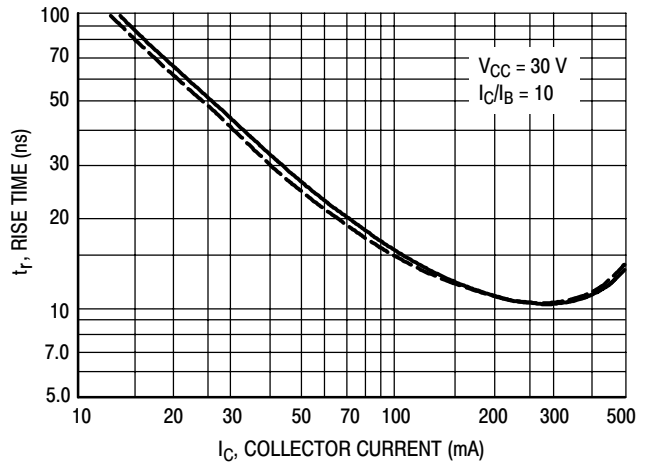

Figure 6. Rise Time

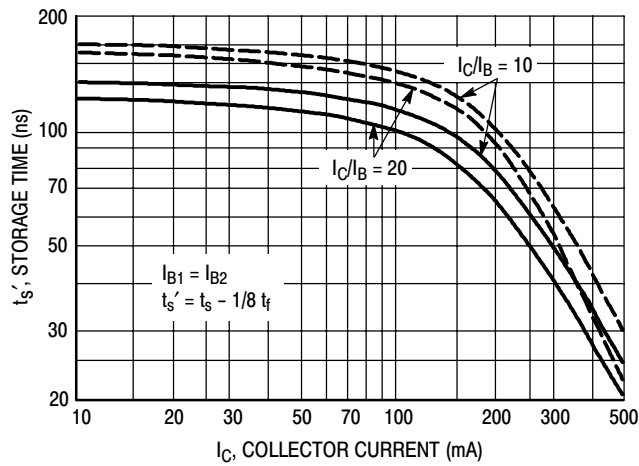

Figure 7. Storage Time

# MMBT4403WT1

## SMALL-SIGNAL CHARACTERISTICS NOISE FIGURE

$V_{CE} = -10 \text{ Vdc}$ ,  $T_A = 25^\circ\text{C}$ ; Bandwidth = 1.0 Hz

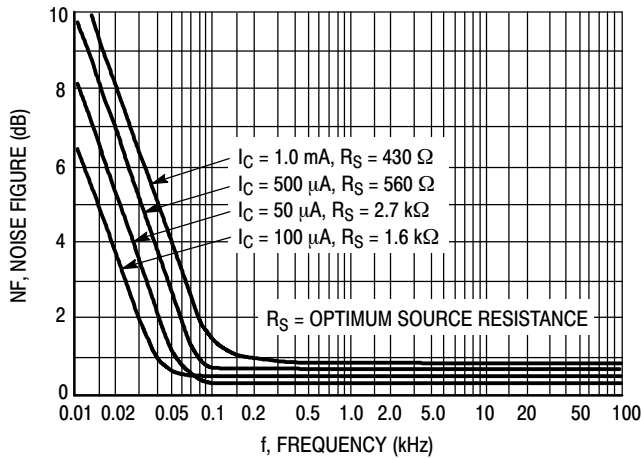

Figure 8. Frequency Effects

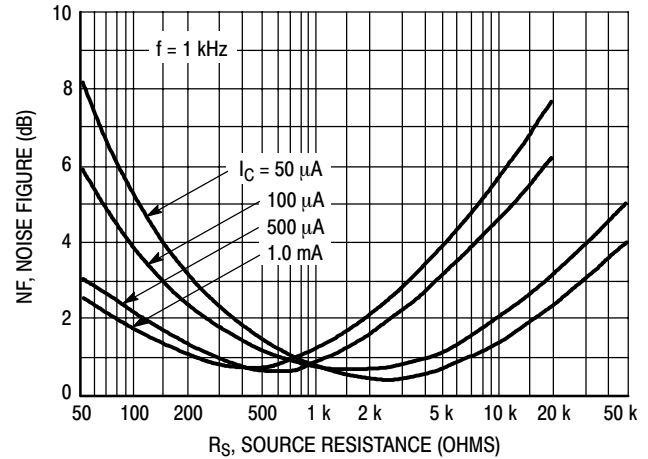

Figure 9. Source Resistance Effects

## h PARAMETERS

$V_{CE} = 10 \text{ Vdc}$ ,  $f = 1.0 \text{ kHz}$ ,  $T_A = 25^\circ\text{C}$

This group of graphs illustrates the relationship between  $h_{fe}$  and other "h" parameters for this series of transistors. To obtain these curves, a high-gain and a low-gain unit were selected from the MMBT4403LT1 lines, and the same units were used to develop the correspondingly numbered curves on each graph.

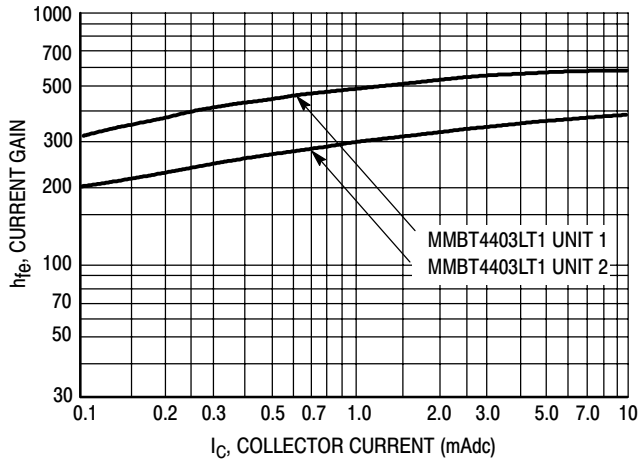

Figure 10. Current Gain

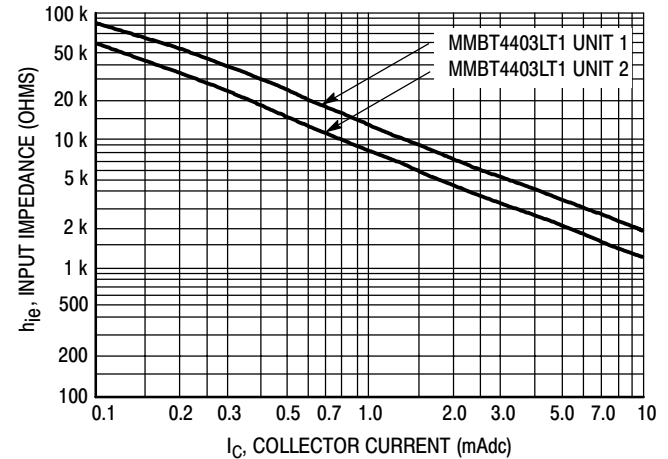

Figure 11. Input Impedance

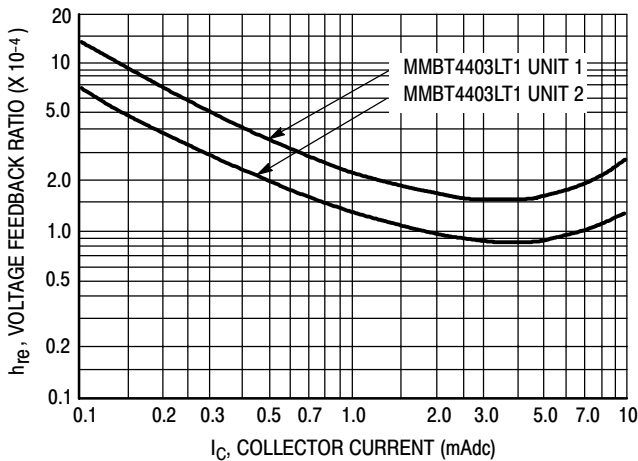

Figure 12. Voltage Feedback Ratio

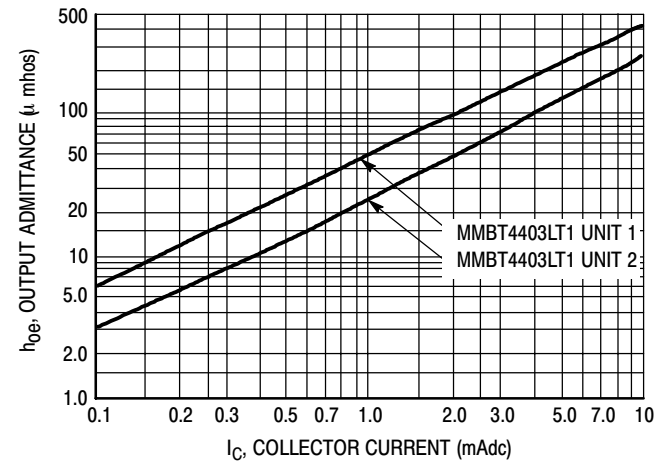

Figure 13. Output Admittance

# MMBT4403WT1

## STATIC CHARACTERISTICS

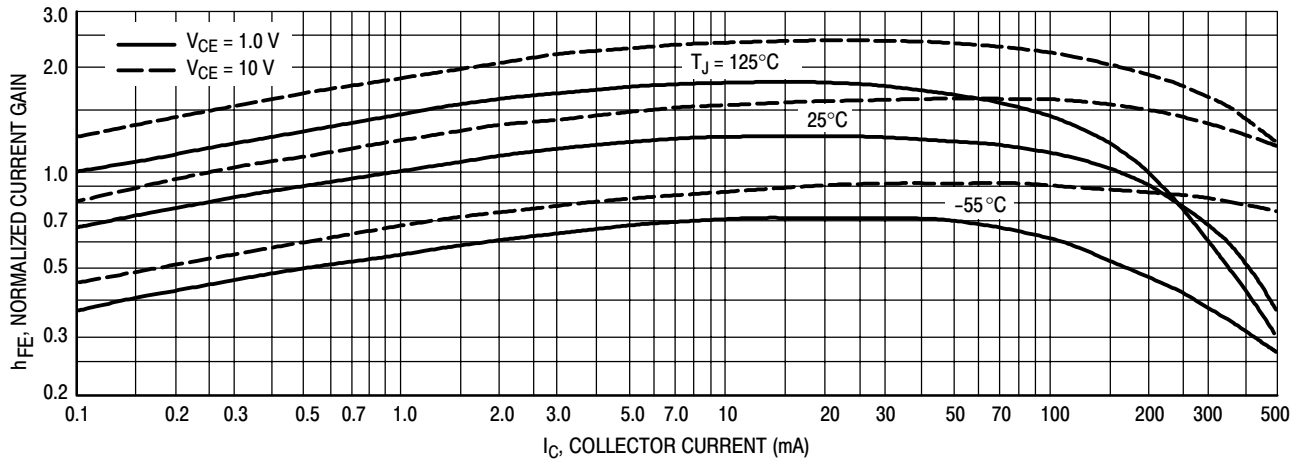

Figure 14. DC Current Gain

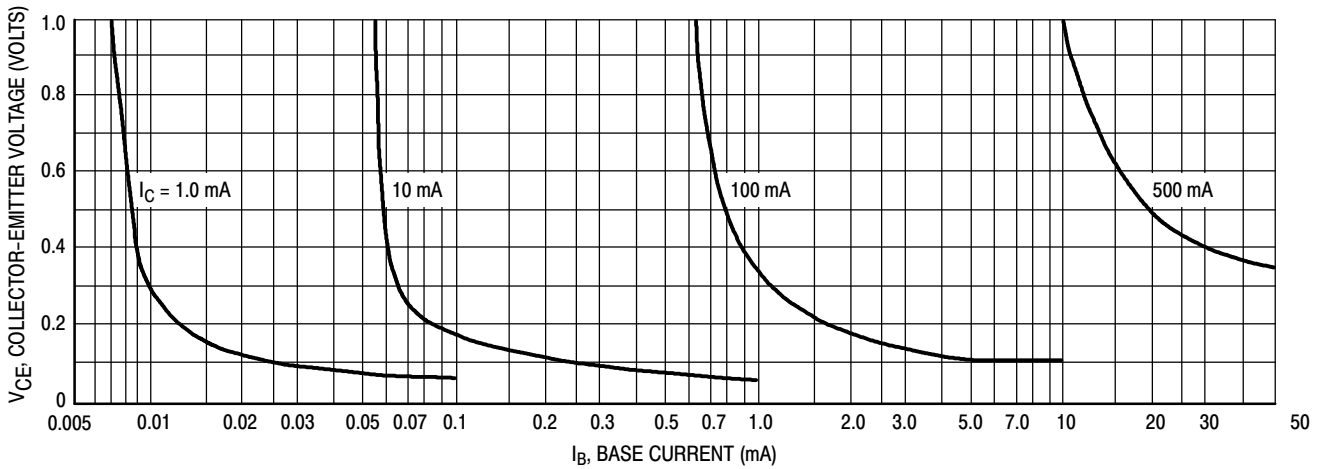

Figure 15. Collector Saturation Region

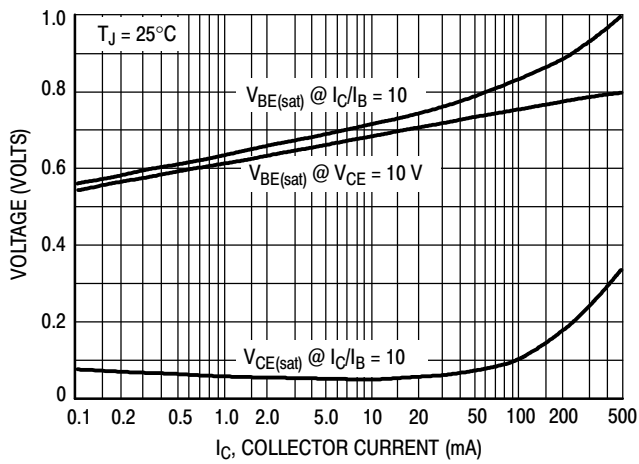

Figure 16. "On" Voltages

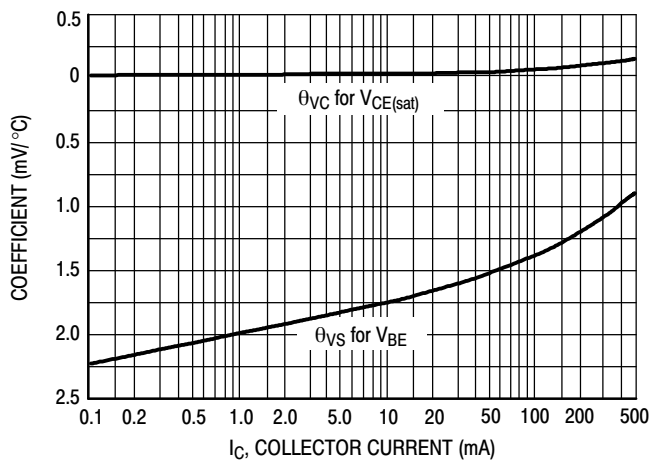
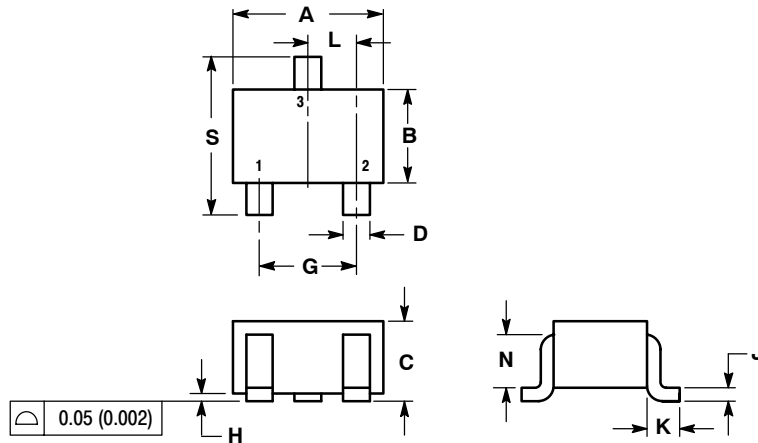

Figure 17. Temperature Coefficients

# MMBT4403WT1

## PACKAGE DIMENSIONS

SC-70/SOT-323  
CASE 419-04  
ISSUE L



NOTES:

1. DIMENSIONING AND TOLERANCING PER ANSI Y14.5M, 1982.
2. CONTROLLING DIMENSION: INCH.

DIM	INCHES		MILLIMETERS	
	MIN	MAX	MIN	MAX
A	0.071	0.087	1.80	2.20
B	0.045	0.053	1.15	1.35
C	0.032	0.040	0.80	1.00
D	0.012	0.016	0.30	0.40
G	0.047	0.055	1.20	1.40
H	0.000	0.004	0.00	0.10
J	0.004	0.010	0.10	0.25
K	0.017 REF		0.425 REF	
L	0.026 BSC		0.650 BSC	
N	0.028 REF		0.700 REF	
S	0.079	0.095	2.00	2.40

STYLE 3:

- PIN 1. BASE
- EMITTER
- COLLECTOR

### SOLDERING FOOTPRINT\*

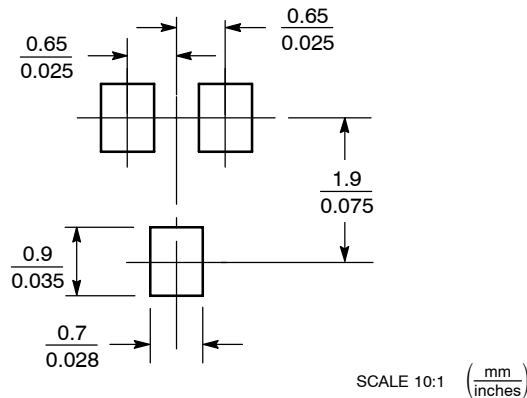

### SC-70/SOT-323

\*For additional information on our Pb-Free strategy and soldering details, please download the ON Semiconductor Soldering and Mounting Techniques Reference Manual, SOLDERRM/D.

ON Semiconductor and are registered trademarks of Semiconductor Components Industries, LLC (SCILLC). SCILLC reserves the right to make changes without further notice to any products herein. SCILLC makes no warranty, representation or guarantee regarding the suitability of its products for any particular purpose, nor does SCILLC assume any liability arising out of the application or use of any product or circuit, and specifically disclaims any and all liability, including without limitation special, consequential or incidental damages. "Typical" parameters which may be provided in SCILLC data sheets and/or specifications can and do vary in different applications and actual performance may vary over time. All operating parameters, including "Typicals" must be validated for each customer application by customer's technical experts. SCILLC does not convey any license under its patent rights nor the rights of others. SCILLC products are not designed, intended, or authorized for use as components in systems intended for surgical implant into the body, or other applications intended to support or sustain life, or for any other application in which the failure of the SCILLC product could create a situation where personal injury or death may occur. Should Buyer purchase or use SCILLC products for any such unintended or unauthorized application, Buyer shall indemnify and hold SCILLC and its officers, employees, subsidiaries, affiliates, and distributors harmless against all claims, costs, damages, and expenses, and reasonable attorney fees arising out of, directly or indirectly, any claim of personal injury or death associated with such unintended or unauthorized use, even if such claim alleges that SCILLC was negligent regarding the design or manufacture of the part. SCILLC is an Equal Opportunity/Affirmative Action Employer. This literature is subject to all applicable copyright laws and is not for resale in any manner.

### PUBLICATION ORDERING INFORMATION

**LITERATURE FULFILLMENT:**  
Literature Distribution Center for ON Semiconductor  
P.O. Box 61312, Phoenix, Arizona 85082-1312 USA  
**Phone:** 480-829-7710 or 800-344-3860 Toll Free USA/Canada  
**Fax:** 480-829-7709 or 800-344-3867 Toll Free USA/Canada  
**Email:** orderlit@onsemi.com

**N. American Technical Support:** 800-282-9855 Toll Free USA/Canada

**Japan:** ON Semiconductor, Japan Customer Focus Center  
2-9-1 Kamimeguro, Meguro-ku, Tokyo, Japan 153-0051  
**Phone:** 81-3-5773-3850

**ON Semiconductor Website:** <http://onsemi.com>

**Order Literature:** <http://www.onsemi.com/litorder>

For additional information, please contact your local Sales Representative.