

# MBR340

Preferred Device

## Axial Lead Rectifier

...employing the Schottky Barrier principle in a large area metal-to-silicon power diode. State-of-the-art geometry features epitaxial construction with oxide passivation and metal overlap contact. Ideally suited for use as rectifiers in low-voltage, high-frequency inverters, free wheeling diodes, and polarity protection diodes.

- Extremely Low  $V_F$
- Low Power Loss/High Efficiency
- Highly Stable Oxide Passivated Junction
- Low Stored Charge, Majority Carrier Conduction

### Mechanical Characteristics:

- Case: Epoxy, Molded
- Weight: 1.1 gram (approximately)
- Finish: All External Surfaces Corrosion Resistant and Terminal Leads are Readily Solderable
- Lead and Mounting Surface Temperature for Soldering Purposes: 220°C Max. for 10 Seconds, 1/16" from case
- Shipped in plastic bags, 500 per bag
- Available Tape and Reeled, 1500 per reel, by adding a "RL" suffix to the part number
- Polarity: Cathode indicated by Polarity Band
- Marking: B340

### MAXIMUM RATINGS

Rating	Symbol	Max	Unit
Peak Repetitive Reverse Voltage Working Peak Reverse Voltage DC Blocking Voltage	$V_{RRM}$ $V_{RWM}$ $V_R$	40	V
Average Rectified Forward Current $T_A = 65^\circ\text{C}$ ( $R_{\theta JA} = 28^\circ\text{C/W}$ , P.C. Board Mounting)	$I_O$	3.0	A
Non-Repetitive Peak Surge Current (Note 1.) (Surge Applied at Rated Load Conditions Halfwave, Single Phase, 60 Hz, $T_L = 75^\circ\text{C}$ )	$I_{FSM}$	80	A
Operating and Storage Junction Temperature Range (Reverse Voltage Applied)	$T_J, T_{stg}$	-65 to +150	°C
Peak Operating Junction Temperature (Forward Current Applied)	$T_{J(pk)}$	150	°C

1. Lead Temperature reference is cathode lead 1/32" from case.



ON Semiconductor™

<http://onsemi.com>

**SCHOTTKY BARRIER  
RECTIFIER  
3.0 AMPERES  
40 VOLTS**

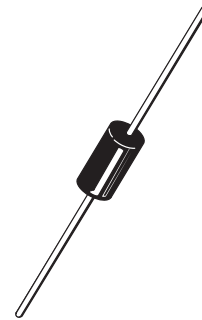

AXIAL LEAD  
CASE 267-03  
STYLE 1

### MARKING DIAGRAM

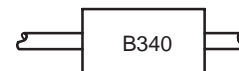

B340 = Device Code

### ORDERING INFORMATION

Device	Package	Shipping
MBR340	Axial Lead	500 Units/Bag
MBR340P	Axial Lead	500 Units/Bag
MBR340PRL	Axial Lead	1500/Tape & Reel
MBR340RL	Axial Lead	1500/Tape & Reel

Preferred devices are recommended choices for future use and best overall value.

# MBR340

## THERMAL CHARACTERISTICS

Characteristic	Symbol	Max	Unit
Thermal Resistance, Junction to Ambient (see Note 3., Mounting Method 3)	$R_{\theta JA}$	28	$^{\circ}C/W$

## ELECTRICAL CHARACTERISTICS ( $T_L = 25^{\circ}C$ unless otherwise noted) (Note 1.)

Characteristic	Symbol	Max	Unit
Maximum Instantaneous Forward Voltage (Note 2.) ( $i_F = 1.0$ Amp) ( $i_F = 3.0$ Amp) ( $i_F = 9.4$ Amp)	$V_F$	0.500 0.600 0.850	V
Maximum Instantaneous Reverse Current @ Rated dc Voltage (Note 2.) $T_L = 25^{\circ}C$ $T_L = 100^{\circ}C$	$i_R$	0.60 20	mA

- Lead Temperature reference is cathode lead 1/32" from case.
- Pulse Test: Pulse Width = 300  $\mu s$ , Duty Cycle = 2.0%.

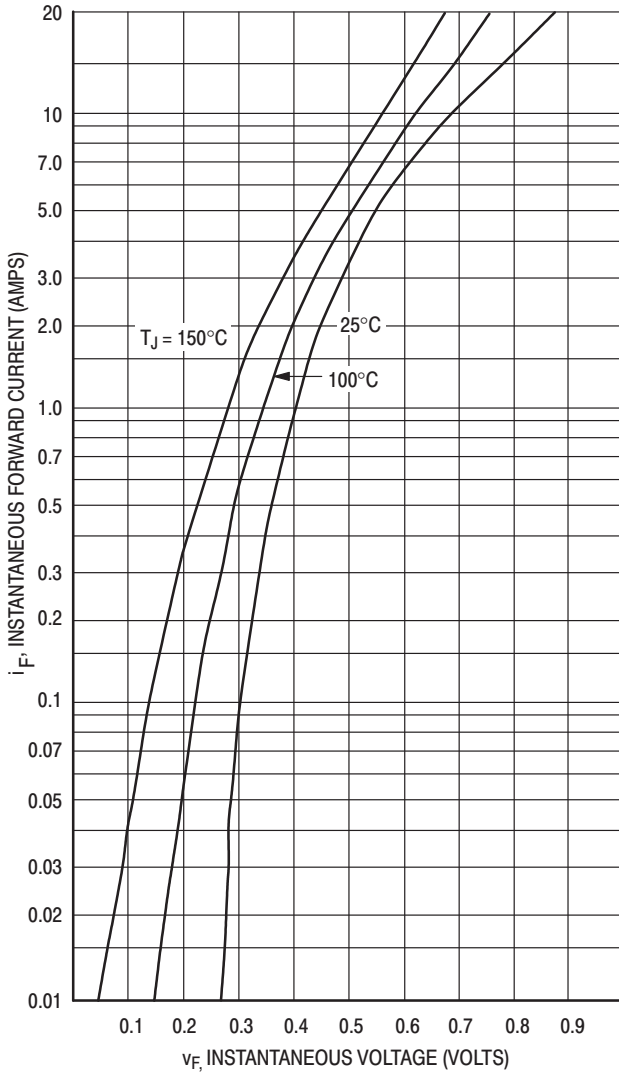

Figure 1. Typical Forward Voltage

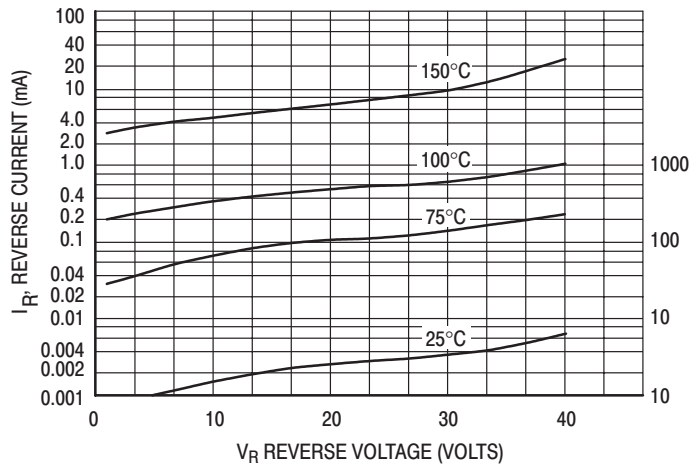

Figure 2. Typical Reverse Current\*

\*The curves shown are typical for the highest voltage device in the voltage grouping. Typical reverse current for lower voltage selections can be estimated from these same curves if  $V_R$  is sufficiently below rated  $V_R$ .

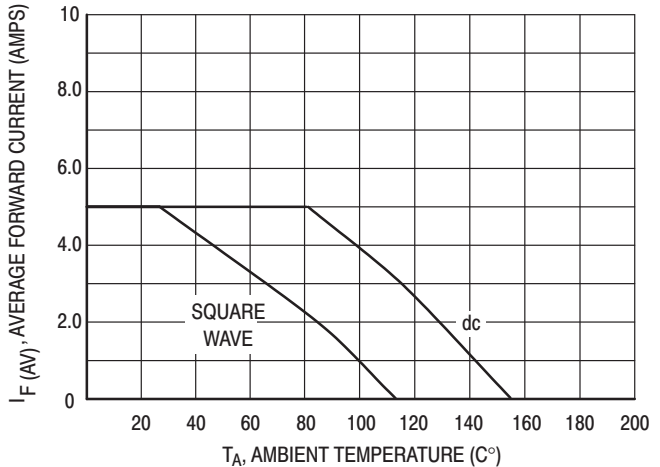

Figure 3. Current Derating  
(Mounting Method #3 per Note 3.)

# MBR340

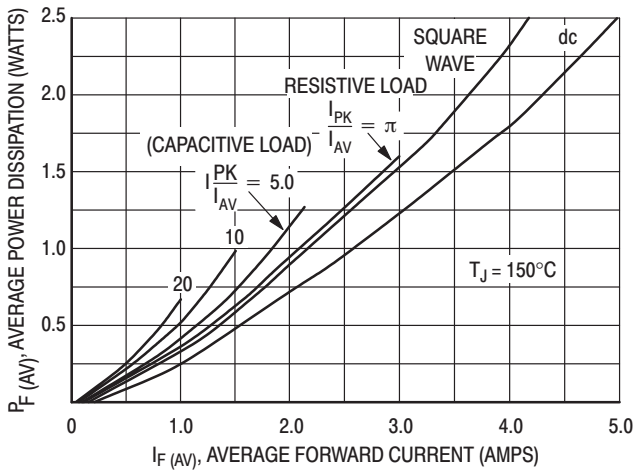

Figure 4. Power Dissipation

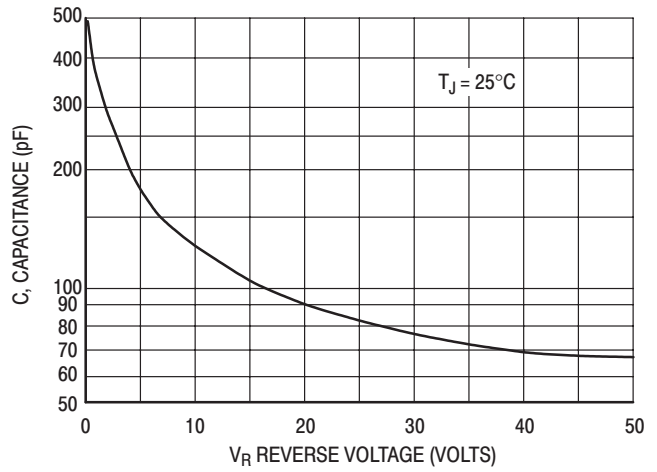

Figure 5. Typical Capacitance

### NOTE 3. — MOUNTING DATA

Data shown for thermal resistance junction-to-ambient ( $R_{\theta JA}$ ) for the mountings shown is to be used as typical guideline values for preliminary engineering, or in case the tie point temperature cannot be measured.

#### TYPICAL VALUES FOR $R_{\theta JA}$ IN STILL AIR

Mounting Method	Lead Length, L (in)				$R_{\theta JA}$
	1/8	1/4	1/2	3/4	
1	50	51	53	55	$^{\circ}\text{C}/\text{W}$
2	58	59	61	63	$^{\circ}\text{C}/\text{W}$
3	28				$^{\circ}\text{C}/\text{W}$

#### Mounting Method 1

P.C. Board where available copper surface is small.

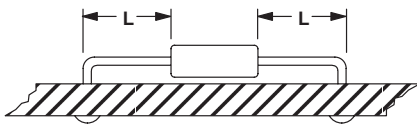

#### Mounting Method 2

Vector Push-In  
Terminals T-28

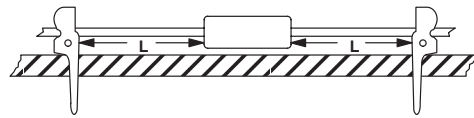

#### Mounting Method 3

P.C. Board with  
2-1/2" X 2-1/2"  
copper surface.

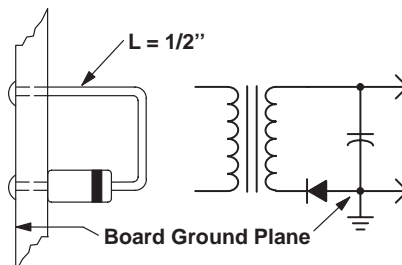

# RECTIFIER NUMBERING SYSTEM

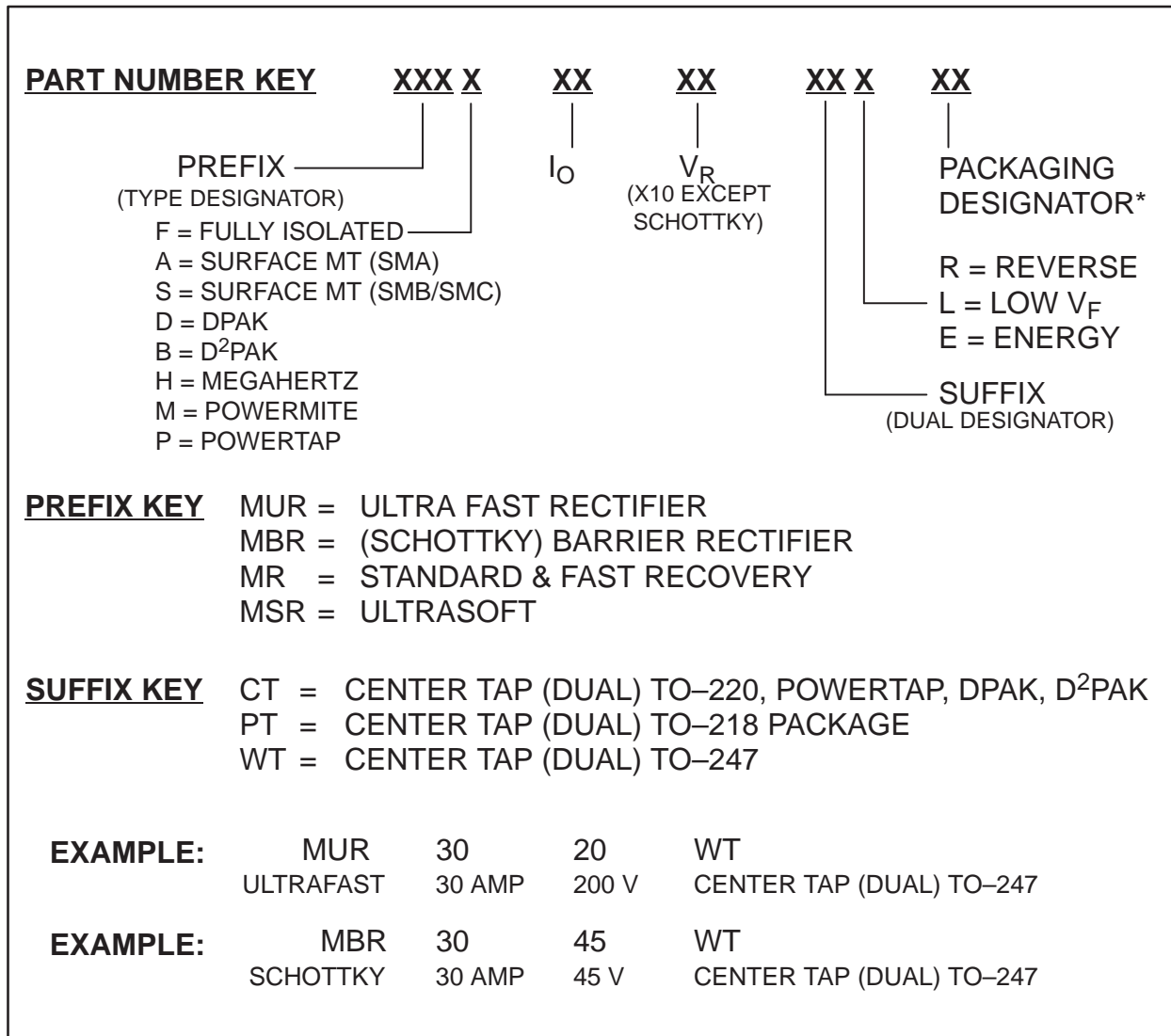

\*For available packaging options consult Sales Office or see Data Sheet.

## Application Specific Rectifiers

Table 1. Low  $V_F$  Schottky Rectifiers

Device	$I_O$ (Amps)	$V_{RRM}$ (Volts)	$V_F$ @ Rated $I_O$ and $T_C = 25^\circ\text{C}$ Volts (Max)	$I_R$ @ Rated $V_{RRM}$ mAmps (Max)	Package
<i>MBR0520LT1, T3</i>	0.5	20	0.33	0.25	SOD-123
<i>MBRS130LT3</i>	1	30	0.395	1	SMB
<i>MBRD835L</i>	8	35	0.41	1.4	DPAK
<i>MBRD1035CTL</i>	10	35	0.41	6	DPAK
<i>MBR2030CTL</i>	20	30	0.48	5	TO-220
<i>MBRB2535CTL</i>	25	35	0.41	10	D <sup>2</sup> PAK
<i>MBR2535CTL</i>	25	35	0.41	5	TO-220
<i>MBRB2515L</i>	25	15	0.42	15	D <sup>2</sup> PAK
<i>MBR2515L</i>	25	15	0.42	15	TO-220
<i>MBRB3030CTL</i>	30	30	0.51	5	D <sup>2</sup> PAK
<i>MBR4015LWT</i>	40	15	0.42	5	TO-247
<i>MBRP20030CTL</i>	200	30	0.52	5	POWERTAP II
<i>MBRP20035L</i>	200	35	0.57	10	POWERTAP III
<i>MBRP30035L</i>	300	35	0.57	10	POWERTAP III
<i>MBRP40045CTL</i>	400	45	0.57	10	POWERTAP II
<i>MBRP400100CTL</i>	400	100	0.83	6	POWERTAP II
<i>MBRP60035CTL</i>	600	35	0.57	10	POWERTAP II

Table 2. MEGAHERTZ™ Rectifiers

Device	$I_O$ (Amps)	$V_{RRM}$ (Volts)	Maximum		$t_{rr}$ (Nanosecond)
			$V_F$ @ Rated $I_O$ and Temp. (Volts)	$I_R$ @ Rated $V_{RRM}$ (mAmps)	
<i>MURH840CT/MURHB840CT</i>	8	400	1.7	0.01	28
<i>MURH860CT</i>	8	600	2.0	0.01	35
<i>MURHB860CT</i>	8	600	2.0	0.01	35
<i>MURHF860CT</i>	8	600	2.0	0.01	35

Table 3. UltraSoft Rectifiers (For High Speed Rectification)

Device	$I_O$ (Amps)	$V_{RRM}$ (Volts)	Max $V_F$ @ $I_F$ (Volts)	Max $t_{rr}$ (nSec)	$T_{JMax}$ ( $^\circ\text{C}$ )
<i>MSRP10040</i>	100	400	1.75 @ 100 A	75	150
<i>MSRD620CT</i>	6	200	1.2 @ 6.0 A	55	150
<i>MSR860</i>	8	600	1.7 @ 8.0 A	120	150
<i>MSR1560</i>	15	600	1.8 @ 15 A	45	150

Table 4. Energy Rated Rectifiers

Device	$I_O$ (Amps)	$V_{RRM}$ (Volts)	Max $V_F$ @ Rated unless Noted (Volts)	$I_R$ @ $V_{RRM}$ (mAmps)	$W_{aval}$ (M <sub>J</sub> )
<i>MUR180E</i>	1.0	800	1.75	10	10
<i>MUR1100E</i>	1.0	1000	1.75	10	10
<i>MUR480E</i>	4.0	800	1.75	25	20
<i>MUR4100E</i>	4.0	1000	1.75	25	20
<i>MUR880E</i>	8.0	800	1.8	25	20
<i>MUR8100E</i>	8.0	1000	1.8	25	20
<i>MUR10120E</i>	10	1200	2.2 @ 6.5 A	100	20
<i>MUR10150E</i>	10	1500	2.5 @ 6.5 A	100	20
<i>MUR5150E</i>	5.0	1500	2.4	50	20

Table 5. Automotive Transient Suppressors

Device	$I_O$ (Amps)	$V_{RRM}$ (Volts)	Max $V_F$ @ $I_F$ (Volts)	$I_{RSM}$ (Amps)	$T_{JMax}$ ( $^\circ\text{C}$ )
<i>MR2535L</i>	6.0	20	1.1 @ 100 A	62 @ 10 mS	175
<i>MR2835S</i>	32	23	1.1 @ 100 A	62 @ 10 mS	175
<i>MR3227N, P</i>	32	18	1.18 @ 100 A	90 @ 10 mS	200
<i>MR4027N, P</i>	40	18	1.1 @ 100 A	110 @ 10 mS	200
<i>MR4045N, P</i>	40	30	1.1 @ 100 A	55 @ 10 mS	200

## SCHOTTKY Rectifiers

Table 6. Surface Mount Schottky Rectifiers

$V_{RRM}$ (Volts)	$I_O^{(1)}$ (Amperes)	$I_O$ Rating Condition	Device	Max $V_F$ @ $i_F$ $T_C = 25^\circ\text{C}$ (Volts)	$I_{FSM}$ (Amperes)	$T_J$ Max ( $^\circ\text{C}$ )	Max $I_R^{(2)}$ $T_J = 25^\circ\text{C}$ (mA)	Max $I_R^{(3)}$ (mA)	Package
20	0.5	$T_L = 90^\circ\text{C}$	<i>MBR0520LT1</i> <i>MBR0520LT3</i>	0.310 @ 0.1 A 0.385 @ 0.5 A	5	125	.075 @ 10 V .250 @ 20 V	5 @ 10 V 8 @ 20 V	<b>CASE 425-04</b> (SOD-123) Cathode = Band 
30	0.5	$T_L = 100^\circ\text{C}$	<i>MBR0530T1</i> <i>MBR0530T3</i>	0.375 @ 0.1 A 0.430 @ 0.5 A	5	125	.020 @ 15 V .130 @ 30 V	-	
40	0.5	$T_L = 110^\circ\text{C}$	<i>MBR0540T1</i> <i>MBR0540T3</i>	0.53 @ 0.5 A	5	150	.010 @ 20 V .020 @ 40 V	-	
20	1	$T_C = 130^\circ\text{C}$	<i>MBRM120ET3</i>	0.455 @ 0.1 A 0.530 @ 1.0 A	50	150	0.010 @ 20 V	1.6 @ 20 V	<b>CASE 457-04</b> (POWERMITE®) 
20	1	$T_{tab} \leq 100^\circ\text{C}$	<i>MBRM120LT3</i>	0.36 @ 0.1 A 0.45 @ 1 A	50	125	0.4 @ 20 V	N/A	
30	1	$T_C = 135^\circ\text{C}$	<i>MBRM130LT3*</i>	0.45 @ 1.0 A	50	125	1	N/A	
40	1	$T_{tab} \leq 100^\circ\text{C}$	<i>MBRM140T3</i>	0.39 @ 0.1 A 0.55 @ 1 A	50	125	0.5 @ 40 V	N/A	
30	1	$T_C \leq 105^\circ\text{C}$	<i>MBRA130LT3</i>	0.41 @ 1 A 0.47 @ 2 A	25	125	1.0 @ 30 V 0.4 @ 15 V	25 @ 30 V	<b>CASE 403B-01</b> (SMA) Cathode = Notch or Polarity Band 
40	1	$T_C \leq 100^\circ\text{C}$	<i>MBRA140T3</i>	0.60 @ 1 A 0.73 @ 2 A	25	125	0.5 @ 40 V 0.1 @ 20 V	10 @ 40 V	
20	1	$T_L = 115^\circ\text{C}$	<i>MBRS120T3</i>	0.55 @ 1.0 A	40	125	1	10	<b>CASE 403-03</b> (SMB) Cathode = Notch or Polarity Band 
30	1	$T_L = 120^\circ\text{C}$	<i>MBRS130LT3</i>	0.395 @ 1.0 A	40	125	1	10	
30	1	$T_L = 115^\circ\text{C}$	<i>MBRS130T3</i>	0.55 @ 1.0 A	40	125	1	10	
40	1	$T_L = 115^\circ\text{C}$	<i>MBRS140T3</i>	0.6 @ 1.0 A	40	125	1	10	
40	1	$T_C = 110^\circ\text{C}$	<i>MBRS140LT3</i>	0.5 @ 1.0 A	40	125	0.4	10	
90	1	$T_L = 120^\circ\text{C}$	<i>MBRS190T3</i>	0.75 @ 1.0 A	50	125	0.5	5	
100	1	$T_L = 120^\circ\text{C}$	<i>MBRS1100T3</i>	0.75 @ 1.0 A	40	150	0.5	5	
40	1.5	$T_C = 100^\circ\text{C}$	<i>MBRS1540T3</i>	0.46 @ 1.5 A	40	125	0.8	5.7	
40	2	$T_C \leq 95^\circ\text{C}$	<i>MBRS240LT3</i>	0.43 @ 2 A 0.53 @ 4 A	25	125	2.0 @ 40 V 0.5 @ 20 V	60 @ 40 V 40 @ 20 V	
40	2	$T_C = 103^\circ\text{C}$	<i>MBRS2040LT3</i>	0.43 @ 2 A 0.50 @ 4 A	70	125	0.80 @ 40 V 0.10 @ 20 V	20 @ 40 V 6.0 @ 20 V	
20	3	$T_L = 100^\circ\text{C}$	<i>MBRS320T3</i>	0.50 @ 3.0 A	80	125	2	20	<b>CASE 403A-03</b> (SMC) Cathode = Notch 
30	3	$T_L = 100^\circ\text{C}$	<i>MBRS330T3</i>	0.50 @ 3.0 A	80	125	2	20	
40	3	$T_L = 100^\circ\text{C}$	<i>MBRS340T3</i>	0.525 @ 3.0 A	80	125	2	20	
60	3	$T_L = 100^\circ\text{C}$	<i>MBRS360T3</i>	0.74 @ 3.0 A	80	125	0.5	20	<b>CASE 369A-13</b> (DPAK)  1  4 3  4 "CT" Suffix  1  4 3  4 Non-"CT" Suffix
20	3	$T_C = 125^\circ\text{C}$	<i>MBRD320T4</i>	0.60 @ 3.0 A	75	150	0.2	20 @ 125 $^\circ\text{C}$	
30	3	$T_C = 125^\circ\text{C}$	<i>MBRD330T4</i>	0.60 @ 3.0 A	75	150	0.2	20 @ 125 $^\circ\text{C}$	
40	3	$T_C = 125^\circ\text{C}$	<i>MBRD340T4</i>	0.60 @ 3.0 A	75	150	0.2	20 @ 125 $^\circ\text{C}$	
50	3	$T_C = 125^\circ\text{C}$	<i>MBRD350T4</i>	0.60 @ 3.0 A	75	150	0.2	20 @ 125 $^\circ\text{C}$	
60	3	$T_C = 125^\circ\text{C}$	<i>MBRD360T4</i>	0.60 @ 3.0 A	75	150	0.2	20 @ 125 $^\circ\text{C}$	
20	6	$T_C = 130^\circ\text{C}$	<i>MBRD620CTT4</i>	0.70 @ 3.0 A	75	150	0.1	15 @ 125 $^\circ\text{C}$	
30	6	$T_C = 130^\circ\text{C}$	<i>MBRD630CTT4</i>	0.70 @ 3.0 A	75	150	0.1	15 @ 125 $^\circ\text{C}$	
40	6	$T_C = 130^\circ\text{C}$	<i>MBRD640CTT4</i>	0.70 @ 3.0 A	75	150	0.1	15 @ 125 $^\circ\text{C}$	
50	6	$T_C = 130^\circ\text{C}$	<i>MBRD650CTT4</i>	0.70 @ 3.0 A	75	150	0.1	15 @ 125 $^\circ\text{C}$	
60	6	$T_C = 130^\circ\text{C}$	<i>MBRD660CTT4</i>	0.70 @ 3.0 A	75	150	0.1	15 @ 125 $^\circ\text{C}$	
35	8	$T_C = 100^\circ\text{C}$	<i>MBRD835L</i>	0.40 @ 3.0 A 0.51 @ 8.0 A	100	125	1.4	35	
35	10	$T_C = 90^\circ\text{C}$	<i>MBRD1035CTL</i>	0.49 @ 10 A	100	125	2	130 @ 125 $^\circ\text{C}$	

## SCHOTTKY Rectifiers

Table 6. Surface Mount Schottky Rectifiers (continued)

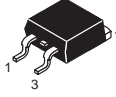
V <sub>RRM</sub> (Volts)	I <sub>O</sub> <sup>(1)</sup> (Amperes)	I <sub>O</sub> Rating Condition	Device	Max V <sub>F</sub> @ i <sub>F</sub> T <sub>C</sub> = 25°C (Volts)	I <sub>FSM</sub> (Amperes)	T <sub>J</sub> Max (°C)	Max I <sub>R</sub> <sup>(2)</sup> T <sub>J</sub> = 25°C (mA)	Max I <sub>R</sub> <sup>(3)</sup> (mA)	Package
10	45	T <sub>C</sub> = 135°C	<i>MBRB1045*</i>	0.84 @ 20 A	150	150	0.1	15 @ 125°C	<p><b>CASE 418B-03</b> (D<sup>2</sup>PAK)</p>  <p>1 3 4</p> <p>"CT" Suffix</p> <p>1 3 4</p> <p>Non-"CT" Suffix</p>
45	15	T <sub>C</sub> = 105°C	<i>MBRB1545CT</i>	0.84 @ 15 A	150	150	0.1	15 @ 125°C	
60	20	T <sub>C</sub> = 110°C	<i>MBRB2060CT</i>	0.95 @ 20 A	150	150	0.15	150 @ 125°C	
100	20	T <sub>C</sub> = 110°C	<i>MBRB20100CT</i>	0.85 @ 10 A 0.95 @ 20 A	150	150	0.1	6 @ 125°C	
200	20	T <sub>C</sub> = 125°C	<i>MBRB20200CT</i>	1.0 @ 20 A	150	150	1	50 @ 125°C	
15	25	T <sub>C</sub> = 90°C	<i>MBRB2515L</i>	0.45 @ 25 A	150	100	15	200 @ 70°C	
35	25	T <sub>C</sub> = 110°C	<i>MBRB2535CTL</i>	0.47 @ 12.5 A 0.55 @ 25 A	150	125	10	500 @ 125°C	
45	25	T <sub>C</sub> = 130°C	<i>MBRB2545CT</i>	0.82 @ 30 A	150	150	0.2	40 @ 125°C	
30	30	T <sub>C</sub> = 115°C	<i>MBRB3030CT</i>	0.54 @ 15 A 0.67 @ 30 A	300	150	1.2	145 @ 150°C 46 @ 10 V, 150°C	
30	30	T <sub>C</sub> = 95°C	<i>MBRB3030CTL</i>	0.45 @ 15 A 0.51 @ 30 A	150	125	2	195 @ 125°C 75 @ 10 V, 125°C	
30	40	T <sub>C</sub> = 110°C	<i>MBRB4030</i>	0.46 @ 20 A 0.55 @ 40 A	300	150	1	150 @ 125°C	

<sup>(1)</sup>I<sub>O</sub> is total device current capability.



<sup>(2)</sup>V<sub>RRM</sub> unless noted

<sup>(3)</sup>V<sub>RRM</sub>, T<sub>J</sub> = 100°C unless noted

★New Product

All devices listed are ON Semiconductor preferred devices

Table 7. Axial Lead Schottky Rectifiers

V <sub>RRM</sub> (Volts)	I <sub>O</sub> (Amperes)	I <sub>O</sub> Rating Condition	Device	Max V <sub>F</sub> @ i <sub>F</sub> T <sub>C</sub> = 25°C (Volts)	I <sub>FSM</sub> (Amperes)	T <sub>J</sub> Max (°C)	Max I <sub>R</sub> <sup>(2)</sup> T <sub>L</sub> = 25°C (mA)	Max I <sub>R</sub> <sup>(3)</sup> T <sub>L</sub> (mA)	Package
20	1	T <sub>A</sub> = 55°C R <sub>θJA</sub> = 80°C/W	<i>1N5817</i>	0.45 @ 1.0 A	25	125	1	10	<p><b>CASE 59-04</b> Plastic</p>  <p>Cathode = Polarity Band</p>
30	1	T <sub>A</sub> = 55°C R <sub>θJA</sub> = 80°C/W	<i>1N5818</i>	0.55 @ 1.0 A	25	125	1	10	
40	1	T <sub>A</sub> = 55°C R <sub>θJA</sub> = 80°C/W	<i>1N5819</i>	0.60 @ 1.0 A	25	125	1	10	
50	1	T <sub>A</sub> = 55°C	<i>MBR150</i>	0.75 @ 1.0 A	25	150	0.5	5	
60	1	T <sub>A</sub> = 55°C R <sub>θJA</sub> = 80°C/W	<i>MBR160</i>	0.75 @ 1.0 A	25	150	0.5	5	
100	1	T <sub>A</sub> = 120°C R <sub>θJA</sub> = 50°C/W	<i>MBR1100</i>	0.79 @ 1.0 A	50	150	0.5	5	
20	3	T <sub>A</sub> = 76°C R <sub>θJA</sub> = 28°C/W	<i>1N5820</i>	0.457 @ 3.0 A	80	125	2	20	<p><b>CASE 267-03</b> Plastic</p>  <p>Cathode = Polarity Band</p>
30	3	T <sub>A</sub> = 71°C R <sub>θJA</sub> = 28°C/W	<i>1N5821</i>	0.500 @ 3.0 A	80	125	2	20	
40	3	T <sub>A</sub> = 61°C R <sub>θJA</sub> = 28°C/W	<i>1N5822</i>	0.525 @ 3.0 A	80	125	2	20	
40	3	T <sub>A</sub> = 65°C R <sub>θJA</sub> = 28°C/W	<i>MBR340</i>	0.600 @ 3.0 A	80	150	0.6	20	
50	3	T <sub>A</sub> = 65°C	<i>MBR350RL</i>	0.600 @ 3.0 A	80	150	0.6	20	
60	3	T <sub>A</sub> = 65°C R <sub>θJA</sub> = 28°C/W	<i>MBR360RL</i>	0.740 @ 3.0 A	80	150	0.6	20	
100	3	T <sub>A</sub> = 100°C R <sub>θJA</sub> = 28°C/W	<i>MBR3100</i>	0.79 @ 3.0 A	150	150	0.6	20	

<sup>(2)</sup>V<sub>RRM</sub> unless noted

<sup>(3)</sup>V<sub>RRM</sub>, T<sub>J</sub> = 100°C unless noted

**Table 8. TO-220 Thru-Hole Schottky Rectifiers**

V <sub>R</sub> RM (Volts)	I <sub>O</sub> (Amperes)	I <sub>O</sub> Rating Condition	Device	Max V <sub>F</sub> @ i <sub>F</sub> T <sub>C</sub> = 25°C (Volts)	I <sub>FSM</sub> (Amperes)	T <sub>J</sub> Max (°C)	Max I <sub>R</sub> <sup>(2)</sup> T <sub>C</sub> = 25°C (mA)	Max I <sub>R</sub> <sup>(3)</sup> (mA)	Package
35	15	T <sub>C</sub> = 105°C	<i>MBR1535CT</i>	0.84 @ 15 A	150	150	0.1	15 @ 125°C	<p><b>CASE 221A-09 (TO-220AB)</b></p>
45	15	T <sub>C</sub> = 105°C	<i>MBR1545CT</i>	0.84 @ 15 A	150	150	0.1	15 @ 125°C	
100	16	T <sub>C</sub> = 133°C	<i>MBR16100CT</i>	0.84 @ 16 A	150	175	0.1	5 @ 125°C	
30	20	T <sub>C</sub> = 137°C	<i>MBR2030CTL</i>	0.52 @ 10 A 0.58 @ 20 A	150	150	5	40	
45	20	T <sub>C</sub> = 135°C	<i>MBR2045CT</i>	0.84 @ 20 A	150	150	0.1	15 @ 125°C	
60	20	T <sub>C</sub> = 133°C	<i>MBR2060CT</i>	0.85 @ 10 A 0.95 @ 20 A	150	150	0.1	6 @ 125°C	
80	20	T <sub>C</sub> = 133°C	<i>MBR2080CT</i>	0.95 @ 20 A	150	150	0.1	6 @ 125°C	
90	20	T <sub>C</sub> = 133°C	<i>MBR2090CT</i>	0.95 @ 20 A	150	150	0.1	6 @ 125°C	
100	20	T <sub>C</sub> = 133°C	<i>MBR20100CT</i>	0.85 @ 10 A 0.95 @ 20 A	150	150	0.1	6 @ 125°C	
200	20	T <sub>C</sub> = 125°C	<i>MBR20200CT</i>	1.0 @ 20 A	150	150	1	50 @ 125°C	
35	25	T <sub>C</sub> = 95°C	<i>MBR2535CTL</i>	0.55 @ 25 A	150	125	5	500 @ 125°C	
45	25	T <sub>C</sub> = 130°C	<i>MBR2545CT</i>	0.82 @ 30 A	150	150	0.2	40 @ 125°C	
45	30	T <sub>C</sub> = 130°C	<i>MBR3045ST</i>	0.76 @ 30 A	150	150	0.2	40 @ 125°C	
35	7.5	T <sub>C</sub> = 105°C	<i>MBR735</i>	0.84 @ 15 A	150	150	0.1	15 @ 125°C	
45	7.5	T <sub>C</sub> = 105°C	<i>MBR745</i>	0.84 @ 15 A	150	150	0.1	15 @ 125°C	
35	10	T <sub>C</sub> = 135°C	<i>MBR1035</i>	0.84 @ 20 A	150	150	0.1	15 @ 125°C	
45	10	T <sub>C</sub> = 135°C	<i>MBR1045</i>	0.84 @ 20 A	150	150	0.1	15 @ 125°C	
60	10	T <sub>C</sub> = 133°C	<i>MBR1060</i>	0.80 @ 10 A	150	150	0.1	6 @ 125°C	
90	10	T <sub>C</sub> = 133°C	<i>MBR1090</i>	0.70 @ 10 A	150	150	0.1	6 @ 125°C	
100	10	T <sub>C</sub> = 133°C	<i>MBR10100</i>	0.80 @ 10 A	150	150	0.1	6 @ 125°C	
35	16	T <sub>C</sub> = 125°C	<i>MBR1635</i>	0.63 @ 16 A	150	150	0.2	40 @ 125°C	
45	16	T <sub>C</sub> = 125°C	<i>MBR1645</i>	0.63 @ 16 A	150	150	0.2	40 @ 125°C	
15	25	T <sub>C</sub> = 90°C	<i>MBR2515L</i>	0.45 @ 25 A	150	100	15	200 @ 70°C	
60	20	T <sub>C</sub> = 133°C	Ⓢ <i>MBRF2060CT</i>	0.95 @ 20 A	150	150	0.15	15 @ 125°C	<p><b>CASE 221D-02 FULL PAK</b></p>
100	20	T <sub>C</sub> = 133°C	Ⓢ <i>MBRF20100CT</i>	0.95 @ 20 A	150	150	0.15	15 @ 125°C	
200	20	T <sub>C</sub> = 125°C	Ⓢ <i>MBRF20200CT</i>	1.0 @ 20 A	150	150	1	50 @ 125°C	
45	25	T <sub>C</sub> = 125°C	Ⓢ <i>MBRF2545CT</i>	0.82 @ 25 A	150	150	0.2	40 @ 125°C	

<sup>(2)</sup>V<sub>R</sub>RM unless noted

<sup>(3)</sup>V<sub>R</sub>RM, T<sub>J</sub> = 100°C unless noted

Ⓢ Indicates UL Recognized – File #E69369

**Table 9. TO-218 and TO-247 Schottky Rectifiers**

V <sub>R</sub> RM (Volts)	I <sub>O</sub> (Amperes)	I <sub>O</sub> Rating Condition	Device	Max V <sub>F</sub> @ i <sub>F</sub> T <sub>C</sub> = 25°C (Volts)	I <sub>FSM</sub> (Amperes)	T <sub>J</sub> Max (°C)	Max I <sub>R</sub> <sup>(2)</sup> T <sub>C</sub> = 25°C (mA)	Max I <sub>R</sub> <sup>(3)</sup> (mA)	Package
45	30	T <sub>C</sub> = 105°C	<i>MBR3045PT</i>	0.76 @ 30 A	200	150	1	100 @ 125°C	<p><b>CASE 340D-02 (TO-218AC)</b></p>
45	40	T <sub>C</sub> = 125°C	<i>MBR4045PT</i>	0.70 @ 20 A 0.80 @ 40 A	400	150	1	50	
45	60	T <sub>C</sub> = 125°C	<i>MBR6045PT</i>	0.62 @ 30 A 0.75 @ 60 A	500	150	1	50	
25	50	T <sub>C</sub> = 125°C	<i>MBR5025L</i>	0.54 @ 30 A 0.62 @ 50 A	300	150	0.5	60	<p><b>CASE 340E-02 (TO-218)</b></p>
45	30	T <sub>C</sub> = 105°C	<i>MBR3045WT</i>	0.76 @ 30 A	200	150	1	100 @ 125°C	<p><b>CASE 340K-01 (TO-247)</b></p>
15	40	T <sub>C</sub> = 125°C	<i>MBR4015LWT</i>	0.42 @ 20 A 0.50 @ 40 A	400	100	5	150 @ 75°C	
45	40	T <sub>C</sub> = 125°C	<i>MBR4045WT</i>	0.70 @ 20 A 0.80 @ 40 A	400	150	1	50	
45	60	T <sub>C</sub> = 125°C	<i>MBR6045WT</i>	0.62 @ 30 A 0.75 @ 60 A	500	150	1	50	

<sup>(2)</sup>V<sub>R</sub>RM unless noted

<sup>(3)</sup>V<sub>R</sub>RM, T<sub>J</sub> = 100°C unless noted



**Table 10. POWERTAP II Schottky Rectifiers**

V <sub>RRM</sub> (Volts)	I <sub>O</sub> <sup>(1)</sup> (Amperes)	I <sub>O</sub> Rating Condition	Device	Max V <sub>F</sub> @ i <sub>F</sub> T <sub>C</sub> = 25°C (Volts)	I <sub>FSM</sub> (Amperes)	T <sub>J</sub> Max (°C)	Max I <sub>R</sub> (2) T <sub>C</sub> = 25°C (mA)	Max I <sub>R</sub> (3) (mA)	Package
30	200	T <sub>C</sub> = 125°C	<i>MBRP20030CTL</i>	0.52 @ 100 A 0.60 @ 200 A	1500	150	5	-	<b>CASE 357C-03 POWER TAP™</b>   Cathode = Mounting Plate Anode = Terminal
30	400	T <sub>C</sub> = 100°C	<i>MBRP40030CTL*</i>	0.50 @ 200 A	1500	150	20	1000 @ 100°C	
35	600	T <sub>C</sub> = 100°C	<i>MBRP60035CTL</i>	0.57 @ 300 A	4000	150	10	250	
45	200	T <sub>C</sub> = 125°C	<i>MBRP20045CT</i>	0.78 @ 100 A	1500	150	0.5	50 @ 125°C	
45	300	T <sub>C</sub> = 120°C	<i>MBRP30045CT</i>	0.70 @ 150 A 0.82 @ 300 A	2500	150	0.8	75 @ 125°C	
45	400	T <sub>C</sub> = 100°C	<i>MBRP40045CTL</i>	0.57 @ 200 A	2500	150	10	-	
60	200	T <sub>C</sub> = 125°C	<i>MBRP20060CT</i>	0.800 @ 100 A	1500	150	0.5	50 @ 125°C	
60	300	T <sub>C</sub> = 120°C	<i>MBRP30060CT</i>	0.79 @ 150 A 0.89 @ 300 A	2500	150	0.8	75 @ 125°C	
100	400	T <sub>C</sub> = 100°C	<i>MBRP400100CTL</i>	0.83 @ 200 A	2500	150	6	-	

<sup>(1)</sup>I<sub>O</sub> is total device current capability.

<sup>(2)</sup>V<sub>RRM</sub> unless noted

<sup>(3)</sup>V<sub>RRM</sub>, T<sub>J</sub> = 100°C unless noted

**Table 11. POWERTAP III Schottky Rectifiers**

V <sub>RRM</sub> (Volts)	I <sub>O</sub> <sup>(1)</sup> (Amperes)	I <sub>O</sub> Rating Condition	Device	Max V <sub>F</sub> @ i <sub>F</sub> T <sub>C</sub> = 25°C (Volts)	I <sub>FSM</sub> (Amperes)	T <sub>J</sub> Max (°C)	Max I <sub>R</sub> (2) T <sub>C</sub> = 25°C (μA)	Max I <sub>R</sub> (3) (μA) T <sub>J</sub> = 100°C	Package
35	200	T <sub>C</sub> = 100°C	<i>MBRP20035L</i>	0.57 @ 200 A	2000	150	10	250	<b>CASE 357D-01 POWER TAP™</b>  
	300	T <sub>C</sub> = 100°C	<i>MBRP30035L</i>	0.57 @ 300 A	3000	150	10	250	

<sup>(1)</sup>I<sub>O</sub> is total device current capability.

<sup>(2)</sup>V<sub>RRM</sub> unless noted

<sup>(3)</sup>V<sub>RRM</sub>, T<sub>J</sub> = 100°C unless noted

★New Product

**NEW UltraSoft Rectifiers**

**Table 12. UltraSoft Rectifiers (For High Speed Rectification)**

V <sub>RRM</sub> (Volts)	I <sub>O</sub> <sup>(1)</sup> (Amperes)	I <sub>O</sub> Rating Condition	Device	Max V <sub>F</sub> @ i <sub>F</sub> T <sub>C</sub> = 29°C (Volts)	t <sub>rr</sub> (ηSec)	T <sub>J</sub> Max (°C)	Max I <sub>R</sub> (2) T <sub>C</sub> = 25°C (μA)	Max I <sub>R</sub> (3) (μA) T <sub>J</sub> = 150°C	Package
200	6	T <sub>C</sub> = 145°C	<i>MSRD620CT*</i>	1.2 @ 6.0 A	55	150	5	200	<b>CASE 369A-13 (DPAK)</b>  
600	8	T <sub>C</sub> = 125°C	<i>MSR860</i>	1.7 @ 8.0 A	120	150	10 μA	1000	<b>CASE 221B-04 Style 1</b>  
600	15	T <sub>C</sub> = 125°C	<i>MSR1560</i>	1.8 @ 15 A	45	150	15	5000	
400	100	T <sub>C</sub> = 100°C	<i>MSRP10040*</i>	1.75 @ 100 A	75	150	100	500	<b>CASE 357D-01 POWER TAP™</b>  

<sup>(1)</sup>I<sub>O</sub> is total device current capability.





<sup>(2)</sup>V<sub>RRM</sub> unless noted

<sup>(3)</sup>V<sub>RRM</sub>, T<sub>J</sub> = 150°C unless noted

★New Product

## Ultrafast Rectifiers

Table 13. Surface Mount Ultrafast Rectifiers

V <sub>R</sub> RM (Volts)	I <sub>O</sub> <sup>(1)</sup> (Amperes)	I <sub>O</sub> Rating Condition	Device	Max t <sub>rr</sub> (ns)	Max V <sub>F</sub> @ i <sub>F</sub> T <sub>C</sub> = 25°C (Volts)	I <sub>FSM</sub> (Amperes)	T <sub>J</sub> Max (°C)	Max I <sub>R</sub> <sup>(2)</sup> T <sub>J</sub> = 25°C (μA)	Max I <sub>R</sub> <sup>(4)</sup> (μA) Package	Package
50	1	T <sub>L</sub> = 155°C	<i>MURS105T3</i>	35	0.875 @ 1.0 A	40	175	2	50	<b>SMB</b> Cathode = Polarity Band 
100	1	T <sub>L</sub> = 155°C	<i>MURS110T3</i>	35	0.875 @ 1.0 A	40	175	2	50	
150	1	T <sub>L</sub> = 155°C	<i>MURS115T3</i>	35	0.875 @ 1.0 A	40	175	2	50	
200	1	T <sub>L</sub> = 155°C	<i>MURS120T3</i>	35	0.875 @ 1.0 A	40	175	2	50	
400	1	T <sub>L</sub> = 150°C	<i>MURS140T3</i>	75	1.25 @ 1.0 A	35	175	5	150	
600	1	T <sub>L</sub> = 150°C	<i>MURS160T3</i>	75	1.25 @ 1.0 A	35	175	5	150	
200	2	T <sub>C</sub> = 145°C	<i>MURS220T3</i>	35	0.95 @ 2.0 A	40	175	2	50	
300	2	T <sub>C</sub> = 125°C	<i>MURS230T3</i>	65	1.15 @ 2.0 A	35	175	5	150	
400	2	T <sub>C</sub> = 125°C	<i>MURS240T3</i>	65	1.15 @ 2.0 A	35	175	5	150	
600	2	T <sub>C</sub> = 125°C	<i>MURS260T3</i>	75	1.15 @ 2.0 A	35	175	5	150	
400	3	T <sub>L</sub> = 130°C	<i>MURS320T3</i>	35	0.875 @ 3.0 A	75	175	5	15	<b>SMC</b> Cathode = Notch 
400	3	T <sub>L</sub> = 130°C	<i>MURS340T3</i>	75	1.25 @ 3.0 A	75	175	10	250	
600	3	T <sub>L</sub> = 130°C	<i>MURS360T3</i>	75	1.25 @ 3.0 A	75	175	10	250	
200	6	T <sub>L</sub> = 145°C	<i>MURD620CT</i>	35	1.0 @ 3.0 A	63	175	5	250 @ 125°C	<b>DPAK</b>  1 2 3 4 1 3 4 "CT" Suffix
200	3	T <sub>C</sub> = 158°C	<i>MURD320</i>	35	.95 @ 3.0 A	75	175	5	500 @ 125°C	
400	8	T <sub>L</sub> = 120°C	<i>MURHB840CT</i>	28	2.2 @ 4.0 A	100	175	10	500	<b>D<sup>2</sup>PAK</b>  1 2 3 4 1 3 4 Non-"CT" Suffix
600	8	T <sub>L</sub> = 120°C	<i>MURHB860CT</i>	35	2.8 @ 4.0 A	100	175	10	500	
200	16	T <sub>L</sub> = 150°C	<i>MURB1620CT</i>	35	0.975 @ 8.0 A	100	175	5	250	
600	16	T <sub>C</sub> = 150°C	<i>MURB1660CT</i>	60	1.5 @ 8.0 A	100	175	10	500	

<sup>(1)</sup>I<sub>O</sub> is total device current capability.

<sup>(2)</sup>V<sub>R</sub>RM unless noted

<sup>(4)</sup>V<sub>R</sub>RM, T<sub>J</sub> = 150°C unless noted

★New Product

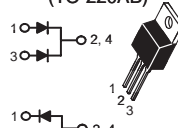
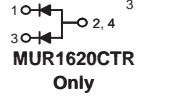
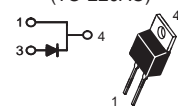

**Table 14. Axial Lead Ultrafast Rectifiers**

V <sub>R</sub> RM (Volts)	I <sub>O</sub> (Amperes)	I <sub>O</sub> Rating Condition	Device	Max t <sub>rr</sub> (ns)	Max V <sub>F</sub> @ i <sub>F</sub> T <sub>C</sub> = 25°C (Volts)	I <sub>FSM</sub> (Amperes)	T <sub>J</sub> Max (°C)	Max I <sub>R</sub> <sup>(2)</sup> T <sub>J</sub> = 25°C (μA)	Max I <sub>R</sub> <sup>(4)</sup> (μA)	Package
50	1	T <sub>A</sub> = 130°C	<i>MUR105</i>	35	0.875 @ 1.0 A	35	175	2	50	 <p><b>CASE 59-04</b> Plastic Cathode = Polarity Band</p>
100	1	T <sub>A</sub> = 130°C	<i>MUR110</i>	35	0.875 @ 1.0 A	35	175	2	50	
150	1	T <sub>A</sub> = 130°C	<i>MUR115</i>	35	0.875 @ 1.0 A	35	175	2	50	
200	1	T <sub>A</sub> = 130°C R <sub>θJA</sub> = 50°C/W	<i>MUR120</i>	25	0.875 @ 1.0 A	35	175	2	50	
300	1	T <sub>A</sub> = 120°C	<i>MUR130</i>	75	1.25 @ 1.0 A	35	175	5	150	
400	1	T <sub>A</sub> = 120°C	<i>MUR140</i>	75	1.25 @ 1.0 A	35	175	5	150	
600	1	T <sub>A</sub> = 120°C R <sub>θJA</sub> = 50°C/W	<i>MUR160</i>	50	1.25 @ 1.0 A	35	175	5	150	
800	1	T <sub>A</sub> = 95°C	<i>MUR180E</i>	100	1.75 @ 1.0 A	35	175	10	600	
1000	1	T <sub>A</sub> = 95°C R <sub>θJA</sub> = 50°C/W	<i>MUR1100E</i>	75	1.75 @ 1.0 A	35	175	10	600 @ 100°C	
200	2	T <sub>A</sub> = 90°C	<i>MUR220</i>	35	0.95 @ 2.0 A	35	175	2	50	
400	2	T <sub>A</sub> = 85°C	<i>MUR240</i>	65	1.15 @ 2.0 A	35	175	5	150	
600	2	T <sub>A</sub> = 60°C	<i>MUR260</i>	75	1.35 @ 2.0 A	35	175	5	150	
1000	2	T <sub>A</sub> = 35°C	<i>MUR2100E</i>	100	2.2 @ 2.0 A	35	175	10	600	
50	4	T <sub>A</sub> = 80°C	<i>MUR405</i>	35	0.89 @ 2.0 A	125	175	5	150	
100	4	T <sub>A</sub> = 80°C	<i>MUR410</i>	35	0.89 @ 2.0 A	125	175	5	150	
150	4	T <sub>A</sub> = 80°C	<i>MUR415</i>	35	0.89 @ 2.0 A	125	175	5	150	
200	4	T <sub>A</sub> = 80°C R <sub>θJA</sub> = 28°C/W	<i>MUR420</i>	25	0.875 @ 3.0 A	125	175	5	150	
400	4	T <sub>A</sub> = 40°C	<i>MUR440</i>	75		75	175	10	250	
600	4	T <sub>A</sub> = 40°C R <sub>θJA</sub> = 28°C/W	<i>MUR460</i>	50	1.25 @ 3.0 A	70	175	10	250	
800	4	T <sub>A</sub> = 35°C	<i>MUR480E</i>	100	1.75 @ 3.0 A	70	175	25	900 @ 100°C	
1000	4	T <sub>A</sub> = 35°C R <sub>θJA</sub> = 28°C/W	<i>MUR4100E</i>	75	1.75 @ 3.0 A	70	175	25	900 @ 100°C	

<sup>(2)</sup>V<sub>R</sub>RM unless noted

<sup>(4)</sup>V<sub>R</sub>RM, T<sub>J</sub> = 150°C unless noted

Table 15. TO-220 Ultrafast and MEGAHERTZ™ Rectifiers

V <sub>RRM</sub> (Volts)	I <sub>O</sub> <sup>(1)</sup> (Amperes)	I <sub>O</sub> Rating Condition	Device	Max t <sub>rr</sub> (ns)	Max V <sub>F</sub> @ i <sub>F</sub> T <sub>C</sub> = 25°C (Volts)	I <sub>FSM</sub> (Amperes)	T <sub>J</sub> Max (°C)	Max I <sub>R</sub> <sup>(2)</sup> T <sub>C</sub> = 25°C (μA)	Max I <sub>R</sub> <sup>(4)</sup> (μA)	Package	
200	6	T <sub>C</sub> = 130°C	<i>MUR620CT</i>	35	0.975 @ 3.0 A	75	175	5	250	<b>CASE 221A-09</b> (TO-220AB) 	
400	8	T <sub>C</sub> = 120°C	<i>MURH840CT</i>	28	2.0 @ 4.0 A	100	175	10	500		
600	8	T <sub>C</sub> = 120°C	<i>MURH860CT</i>	35	2.8 @ 4.0 A	100	175	10	500		
100	16	T <sub>C</sub> = 150°C	<i>MUR1610CT</i>	35	0.975 @ 8.0 A	100	175	5	250		
150	16	T <sub>C</sub> = 150°C	<i>MUR1615CT</i>	35	0.975 @ 8.0 A	100	175	5	250		
200	16	T <sub>C</sub> = 150°C	<i>MUR1620CT</i>	35	0.975 @ 8.0 A	100	175	5	250		
200	16	T <sub>C</sub> = 160°C	<i>MUR1620CTR</i>	85	1.2 @ 8.0 A	100	175	5	500		
400	16	T <sub>C</sub> = 150°C	<i>MUR1640CT</i>	60	1.30 @ 8.0 A	100	175	10	250		
600	16	T <sub>C</sub> = 150°C	<i>MUR1660CT</i>	60	1.5 @ 8.0 A	100	175	10	500		
<b>MUR1620CTR Only</b> 											
50	8	T <sub>C</sub> = 150°C	<i>MUR805</i>	35	0.975 @ 8.0 A	100	175	5	250	<b>CASE 221B-04</b> (TO-220AC) 	
100	8	T <sub>C</sub> = 150°C	<i>MUR810</i>	35	0.975 @ 8.0 A	100	175	5	250		
150	8	T <sub>C</sub> = 150°C	<i>MUR815</i>	35	0.975 @ 8.0 A	100	175	5	250		
200	8	T <sub>C</sub> = 150°C	<i>MUR820</i>	35	0.975 @ 8.0 A	100	175	5	250		
400	8	T <sub>C</sub> = 150°C	<i>MUR840</i>	50	1.30 @ 8.0 A	100	175	10	500		
600	8	T <sub>C</sub> = 150°C	<i>MUR860</i>	50	1.50 @ 8.0 A	100	175	10	500		
800	8	T <sub>C</sub> = 175°C	<i>MUR880E</i>	75	1.80 @ 8.0 A	100	175	25	500 @ 100°C		
100	15	T <sub>C</sub> = 150°C	<i>MUR1510</i>	35	1.05 @ 15 A	200	175	10	500		
150	15	T <sub>C</sub> = 150°C	<i>MUR1515</i>	35	1.05 @ 15 A	200	175	10	500		
200	15	T <sub>C</sub> = 150°C	<i>MUR1520</i>	35	1.05 @ 15 A	200	175	10	500		
400	15	T <sub>C</sub> = 150°C	<i>MUR1540</i>	60	1.25 @ 15 A	150	175	10	500		
600	15	T <sub>C</sub> = 145°C	<i>MUR1560</i>	60	1.50 @ 15 A	150	175	10	1000		
200	20	T <sub>C</sub> = 125°C	<i>MUR2020R</i>	95	1.10 @ 20 A	250	175	50	1000		
1000	8	T <sub>C</sub> = 150°C	<i>MUR8100E</i>	75	1.80 @ 8.0 A	100	175	25	500 @ 100°C		
1200	10	T <sub>C</sub> = 125°C	<i>MUR10120E</i>	175	2.2 @ 6.5 A	100	125	100	1000 @ 125°C		
1500	10	T <sub>C</sub> = 125°C	<i>MUR10150E</i>	175	2.4 @ 6.5 A	100	125	100	1000 @ 125°C		
1500	5	T <sub>C</sub> = 100°C	<i>MUR5150E</i>	175	2.4 @ 5 A	100	125	50	500 @ 125°C		
200	16	T <sub>C</sub> = 150°C	 <i>MURF1620CT</i>	25	0.975 @ 8.0 A	100	150	5	250		<b>CASE 221D-02</b> 
600	16	T <sub>C</sub> = 150°C	<i>MURF1660CT</i>	60	1.5 @ 8.0 A	100	175	10	500		
600	8	T <sub>C</sub> ≤ 120°C	<i>MURHF860CT</i> ★	35	2.8 @ 4.0 A	100	175	10	500		

(1) I<sub>O</sub> is total device capability



(2) V<sub>RRM</sub> unless noted

(4) V<sub>RRM</sub>, T<sub>J</sub> = 150°C unless noted

 Indicates UL Recognized – File #E69369

★ New Product

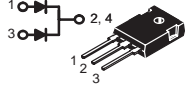
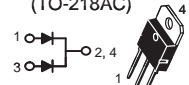
**Table 16. TO-218 and TO-247 Ultrafast Rectifiers**

V <sub>RRM</sub> (Volts)	I <sub>O</sub> (Amperes)	I <sub>O</sub> Rating Condition	Device	Max t <sub>rr</sub> (ns)	Max V <sub>F</sub> @ i <sub>F</sub> T <sub>C</sub> = 25°C (Volts)	I <sub>FSM</sub> (Amperes)	T <sub>J</sub> Max (°C)	Max I <sub>R</sub> <sup>(2)</sup> T <sub>J</sub> = 25°C (μA)	Max I <sub>R</sub> <sup>(4)</sup> (mA)	Package
200	30	T <sub>C</sub> = 145°C	<i>MUR3020WT</i>	35	1.05 @ 15 A	150	175	10	0.5	<b>CASE 340K-01</b> (TO-247) 
600	30	T <sub>C</sub> = 145°C	<i>MUR3060WT</i>	60	1.70 @ 15 A	150	175	10	1	
200	30	T <sub>C</sub> = 150°C	<i>MUR3020PT</i>	35	1.12 @ 15 A	200	175	10	0.5	<b>CASE 340D-02</b> (TO-218AC) 
400	30	T <sub>C</sub> = 150°C	<i>MUR3040PT</i>	60	1.12 @ 15 A	150	175	10	0.5	
600	30	T <sub>C</sub> = 145°C	<i>MUR3060PT</i>	60	1.20 @ 15 A	150	175	10	1	<b>CASE 340E-02</b> (TO-218) 
400	30	T <sub>C</sub> = 70°C	<i>MUR3040</i>	100	1.5 @ 30 A	300	175	35	6 @ 100°C	
800	30	T <sub>C</sub> = 70°C	<i>MUR3080</i>	110	1.90 @ 30 A	300	175	100	5 @ 100°C	
400	60	T <sub>C</sub> = 70°C	<i>MUR6040</i>	100	1.50 @ 60 A	600	175	60	10 @ 100°C	

(1) I<sub>O</sub> is total device capability  
 (2) V<sub>RRM</sub> unless noted  
 (4) V<sub>RRM</sub>, T<sub>J</sub> = 150°C unless noted



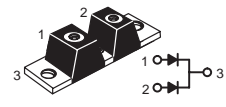



**Table 17. POWER TAP II Ultrafast Rectifiers**

V <sub>RRM</sub> (Volts)	I <sub>O</sub> <sup>(1)</sup> (Amperes)	I <sub>O</sub> Rating Condition	Device	Max t <sub>rr</sub> (ns)	Max V <sub>F</sub> @ i <sub>F</sub> T <sub>C</sub> = 25°C (Volts)	I <sub>FSM</sub> (Amperes)	T <sub>J</sub> Max (°C)	Max I <sub>R</sub> <sup>(2)</sup> T <sub>J</sub> = 25°C (μA)	Max I <sub>R</sub> <sup>(4)</sup> (mA)	Package
200	200	T <sub>C</sub> = 130°C	<i>MURP20020CT</i>	50	1.00 @ 100 A	800	175	150	1 @ 125°C	<b>CASE 357C-03</b> POWER TAP™  Cathode = Mounting Plate Anode = Terminal
400	200	T <sub>C</sub> = 100°C	<i>MURP20040CT</i>	50	1.30 @ 100 A	800	175	50	0.5 @ 125°C	

(1) I<sub>O</sub> is total device current capability. (4) V<sub>RRM</sub>, T<sub>J</sub> = 150°C unless noted  
 (2) V<sub>RRM</sub> unless noted ★ New Product

## Fast Recovery Rectifiers/General-Purpose Rectifiers

Table 18. Fast Recovery Rectifiers/General Purpose Rectifiers

V <sub>RRM</sub> (Volts)	I <sub>O</sub> (Amperes)	I <sub>O</sub> Rating Condition	Device	Max V <sub>F</sub> @ I <sub>F</sub> T <sub>J</sub> = 25°C (Volts)	Max t <sub>rr</sub> (ns)	I <sub>FSM</sub> (Amperes)	T <sub>J</sub> Max (°C)	Max I <sub>R</sub> <sup>(2)</sup> T <sub>J</sub> = 25°C (μA)	Max I <sub>R</sub> <sup>(3)</sup> (μA)	Package
400	1.5	T <sub>L</sub> = 118°C	<i>MRS1504T3</i>	1.04 @ 1.5 A	-	50	150	1	340	CASE 403A-03 SMB 
300	1	T <sub>L</sub> = 150°C	<i>MRA4003T3</i> ★	1.1 @ 1.0 A	-	30	175	10	50	CASE 403B-01 SMA  Cathode = Notch
400	1	T <sub>L</sub> = 150°C	<i>MRA4004T3</i> ★	1.1 @ 1.0 A	-	30	175	10	50	
600	1	T <sub>L</sub> = 150°C	<i>MRA4005T3</i> ★	1.1 @ 1.0 A	-	30	175	10	50	
800	1	T <sub>L</sub> = 150°C	<i>MRA4006T3</i> ★	1.1 @ 1.0 A	-	30	175	10	50	
1000	1	T <sub>L</sub> = 150°C	<i>MRA4007T3</i> ★	1.1 @ 1.0 A	-	30	175	10	50	
50	1	T <sub>A</sub> = 75°C	<i>1N4001RL</i>	1.1 @ 1.0 A	-	30	150	10	50	CASE 59-03 <sup>(7)</sup> Plastic  Cathode = Polarity Band
100	1	T <sub>A</sub> = 75°C	<i>1N4002RL</i>	1.1 @ 1.0 A	-	30	150	10	50	
200	1	T <sub>A</sub> = 75°C	<i>1N4003RL</i>	1.1 @ 1.0 A	-	30	150	10	50	
400	1	T <sub>A</sub> = 75°C	<i>1N4004RL</i>	1.1 @ 1.0 A	-	30	150	10	50	
600	1	T <sub>A</sub> = 75°C	<i>1N4005RL</i>	1.1 @ 1.0 A	-	30	150	10	50	
800	1	T <sub>A</sub> = 75°C	<i>1N4006RL</i>	1.1 @ 1.0 A	-	30	150	10	50	
1000	1	T <sub>A</sub> = 75°C	<i>1N4007RL</i>	1.1 @ 1.0 A	-	30	150	10	50	
50	1	T <sub>A</sub> = 75°C	<i>1N4933RL</i>	1.2 @ 1.0 A	200	30	150	5	100	
100	1	T <sub>A</sub> = 75°C	<i>1N4934RL</i>	1.2 @ 1.0 A	200	30	150	5	100	
200	1	T <sub>A</sub> = 75°C	<i>1N4935RL</i>	1.2 @ 1.0 A	200	30	150	5	100	
400	1	T <sub>A</sub> = 75°C	<i>1N4936RL</i>	1.2 @ 1.0 A	200	30	150	5	100	
600	1	T <sub>A</sub> = 75°C	<i>1N4937RL</i>	1.2 @ 1.0 A	200	30	150	5	100	
50	3	T <sub>L</sub> = 105°C	<i>1N5400RL</i>	1.2 @ 9.4 A	-	200	150	10	500 @ 150°C	
100	3	T <sub>L</sub> = 105°C	<i>1N5401RL</i>	1.2 @ 9.4 A	-	200	150	10	500 @ 150°C	
200	3	T <sub>L</sub> = 105°C	<i>1N5402RL</i>	1.2 @ 9.4 A	-	200	150	10	500 @ 150°C	
400	3	T <sub>L</sub> = 105°C	<i>1N5404RL</i>	1.2 @ 9.4 A	-	200	150	10	500 @ 150°C	
600	3	T <sub>L</sub> = 105°C	<i>1N5406RL</i>	1.2 @ 9.4 A	-	200	150	10	500 @ 150°C	
800	3	T <sub>L</sub> = 105°C	<i>1N5407RL</i>	1.2 @ 9.4 A	-	200	150	10	500 @ 150°C	
1000	3	T <sub>L</sub> = 105°C	<i>1N5408RL</i>	1.2 @ 9.4 A	-	200	150	10	500 @ 150°C	
200	3	T <sub>A</sub> = 80°C <sup>(8)</sup>	<i>MR852RL</i>	1.25 @ 3.0 A	200	100	150	10	150	CASE 267-03 Plastic  Cathode = Polarity Band
400	3	T <sub>A</sub> = 80°C <sup>(8)</sup>	<i>MR854RL</i>	1.25 @ 3.0 A	200	100	150	10	150	
600	3	T <sub>A</sub> = 80°C <sup>(8)</sup>	<i>MR856RL</i>	1.25 @ 3.0 A	200	100	150	10	150	
50	6	T <sub>A</sub> = 60°C R <sub>θJA</sub> = 25°C/W	<i>MR750RL</i>	1.25 @ 100 A	-	400	175	25	1000	
100	6	T <sub>A</sub> = 60°C R <sub>θJA</sub> = 25°C/W	<i>MR751RL</i>	1.25 @ 100 A	-	400	175	25	1000	
200	6	T <sub>A</sub> = 60°C R <sub>θJA</sub> = 25°C/W	<i>MR752RL</i>	1.25 @ 100 A	-	400	175	25	1000	CASE 194-04 Plastic  Cathode indicated by diode symbol
400	6	T <sub>A</sub> = 60°C R <sub>θJA</sub> = 25°C/W	<i>MR754RL</i>	1.25 @ 100 A	-	400	175	25	1000	
600	6	T <sub>A</sub> = 60°C R <sub>θJA</sub> = 25°C/W	<i>MR756RL</i>	1.25 @ 100 A	-	400	175	25	1000	
1000	6	T <sub>A</sub> = 60°C R <sub>θJA</sub> = 25°C/W	<i>MR760RL</i>	1.25 @ 100 A	-	400	175	25	1000	
200	25	T <sub>C</sub> = 150°C	<i>MR2502</i>	1.18 @ 78.5 A	-	400	175	100	500	CASE 193-04 Plastic  Cathode = Polarity Band
400	25	T <sub>C</sub> = 150°C	<i>MR2504</i>	1.18 @ 78.5 A	-	400	175	100	500	
1000	25	T <sub>C</sub> = 150°C	<i>MR2510</i>	1.18 @ 78.5 A	-	400	175	100	500	
250	32	T <sub>C</sub> = 150°C	<i>TRA3225</i>	1.15 @ 100 A	-	500	175	10	250	
250	25	T <sub>C</sub> = 150°C	<i>TRA2525</i>	1.18 @ 100 A	-	400	175	10	250	

<sup>(2)</sup>V<sub>RRM</sub> unless noted

<sup>(3)</sup>V<sub>RRM</sub>, T<sub>J</sub> = 100°C unless noted





<sup>(7)</sup>Package Size: 0.120" max diameter by 0.260" length.

<sup>(8)</sup>Must be derated for reverse power dissipation. See data sheet.

<sup>(9)</sup>Overvoltage Transient Suppressor: 24–32 volts avalanche voltage.

★ New Product

**Table 19. Overvoltage Transient Suppressors**

V <sub>RRM</sub> (Volts)	V <sub>BR</sub> <sup>(1)</sup> (Volts)	V <sub>BR</sub> (Volts)	I <sub>O</sub> (Amperes)	Device	Max V <sub>F</sub> T <sub>J</sub> = 25°C (Volts)	I <sub>FSM</sub> (Amperes)	T <sub>J</sub> Max (°C)	I <sub>RSM</sub> (Amperes)	Max I <sub>P</sub> <sup>(7)</sup> (μA)	Package
23	24-32	40 <sup>(4)</sup>	6 T <sub>L</sub> = 125°C	<b>MR2520L</b>	1.25 I <sub>F</sub> = 100A	400	175	58 <sup>(5)</sup>	10	<b>CASE 194-04</b> Plastic  Cathode = Diode Symbol
20	24-32	40 <sup>(2)</sup>	6 T <sub>C</sub> = 125°C	<b>MR2535L</b>	1.1 I <sub>F</sub> = 100A	400	175	62 <sup>(5)</sup>	0.2	
20	24-32	40 <sup>(3)</sup>	32 T <sub>C</sub> = 150°C	<b>TRA2532</b>	1.18 I <sub>F</sub> = 100A	500	175	80 <sup>(5)</sup>	10	<b>CASE 193-04</b> Plastic  Cathode = Polarity Band
23	24-32	40 <sup>(3)</sup>	32 T <sub>C</sub> = 150°C	<b>MR2835S</b>	1.1 I <sub>F</sub> = 100A	400	175	62 <sup>(5)</sup>	5 @ 20 V	<b>CASE 460-02</b> Top Can  Cathode = Terminal
18	20-27	37 <sup>(3)</sup> 35 <sup>(4)</sup>	32 T <sub>C</sub> = 185°C	<b>MR3227N</b> and <b>MR3227P</b>	1.18 I <sub>F</sub> = 100A	400	200	90 <sup>(5)</sup> 40 <sup>(6)</sup>	1 @ 16 V	<b>CASE 193A-02</b> Button Can  N = Anode to Case P = Cathode to Case
18	20-27	37 <sup>(3)</sup> 35 <sup>(4)</sup>	40 T <sub>C</sub> = 185°C	<b>MR4027N</b> and <b>MR4027P</b>	1.1 I <sub>F</sub> = 100A	500	200	110 <sup>(5)</sup> 50 <sup>(6)</sup>	1 @ 16 V	
30	34-45	55 <sup>(3)</sup> 53 <sup>(4)</sup>	40 T <sub>C</sub> = 185°C	<b>MR4045N</b> and <b>MR4045P</b>	1.1 I <sub>F</sub> = 100A	500	200	55 <sup>(5)</sup> 25 <sup>(6)</sup>	1 @ 28 V	

(1)At I<sub>r</sub> = 100 mA, 25°C

(2)At I<sub>r</sub> = 90 A, T<sub>c</sub> = 150°C, PW = 80 μS

(3)At I<sub>r</sub> = 80 A, T<sub>c</sub> = 85°C, PW = 80 μS

(4)At I<sub>r</sub> = 80 A, T<sub>c</sub> = 25°C, PW = 80 μS

(5)Time Constant = 10 mS, 25°C

(6)Time Constant = 80 mS, 25°C

(7)At V<sub>RRM</sub>, T<sub>J</sub> = 25°C unless noted

# Package Outline Dimensions

## GLASS/PLASTIC DO-41 CASE 59-03 ISSUE M

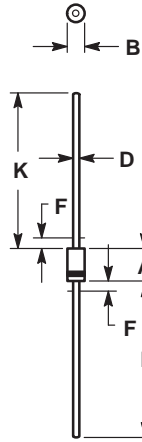

NOTES:

1. ALL RULES AND NOTES ASSOCIATED WITH JEDEC DO-41 OUTLINE SHALL APPLY.
2. POLARITY DENOTED BY CATHODE BAND.
3. LEAD DIAMETER NOT CONTROLLED WITHIN F DIMENSION.

DIM	MILLIMETERS		INCHES	
	MIN	MAX	MIN	MAX
A	4.07	5.20	0.160	0.205
B	2.04	2.71	0.080	0.107
D	0.71	0.86	0.028	0.034
F	---	1.27	---	0.050
K	27.94	---	1.100	---

## MINI MOSORB CASE 59-04 ISSUE M

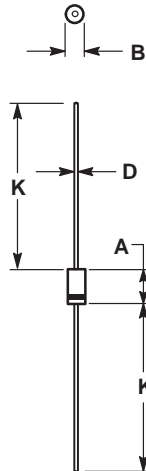

NOTES:

1. ALL RULES AND NOTES ASSOCIATED WITH JEDEC DO-41 OUTLINE SHALL APPLY.
2. POLARITY DENOTED BY CATHODE BAND.
3. LEAD DIAMETER NOT CONTROLLED WITHIN F DIMENSION.

DIM	MILLIMETERS		INCHES	
	MIN	MAX	MIN	MAX
A	5.97	6.60	0.235	0.260
B	2.79	3.05	0.110	0.120
D	0.76	0.86	0.030	0.034
K	27.94	---	1.100	---



PACKAGE OUTLINE DIMENSIONS (continued)

**MICRODE BUTTON**  
CASE 193-04  
ISSUE J

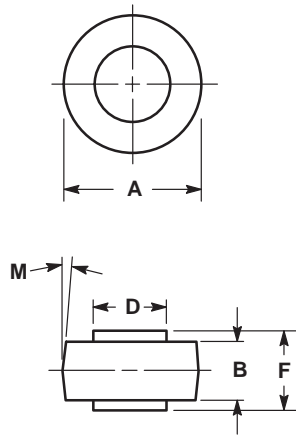

DIM	MILLIMETERS		INCHES	
	MIN	MAX	MIN	MAX
A	8.43	8.69	0.332	0.342
B	4.19	4.45	0.165	0.175
D	5.54	5.64	0.218	0.222
F	5.94	6.25	0.234	0.246
M	5°NOM		5°NOM	

**CAN BUTTON**  
CASE 193A-02  
ISSUE A

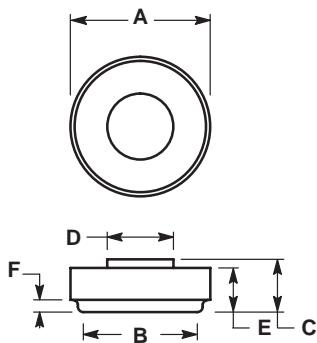

- NOTES:  
1. DIMENSIONING AND TOLERANCING PER ANSI Y14.5M, 1982.  
2. CONTROLLING DIMENSION: MILLIMETER.

DIM	MILLIMETERS		INCHES	
	MIN	MAX	MIN	MAX
A	11.4	11.6	0.449	0.457
B	9.3	9.7	0.366	0.382
C	4.3	4.9	0.169	0.193
D	5.4	5.6	0.213	0.220
E	3.6	4.2	0.142	0.165
F	1.0	2.0	0.039	0.079

PACKAGE OUTLINE DIMENSIONS (continued)

AXIAL LEAD BUTTON  
CASE 194-04  
ISSUE F

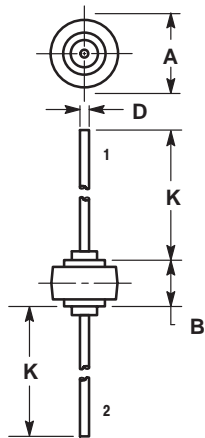

NOTES:  
1. CATHODE SYMBOL ON PACKAGE.

DIM	MILLIMETERS		INCHES	
	MIN	MAX	MIN	MAX
A	8.43	8.69	0.332	0.342
B	5.94	6.25	0.234	0.246
D	1.27	1.35	0.050	0.053
K	25.15	25.65	0.990	1.010

STYLE 1:  
PIN 1. CATHODE  
2. ANODE

TO-220 THREE-LEAD  
TO-220  
CASE 221A-09  
ISSUE AA

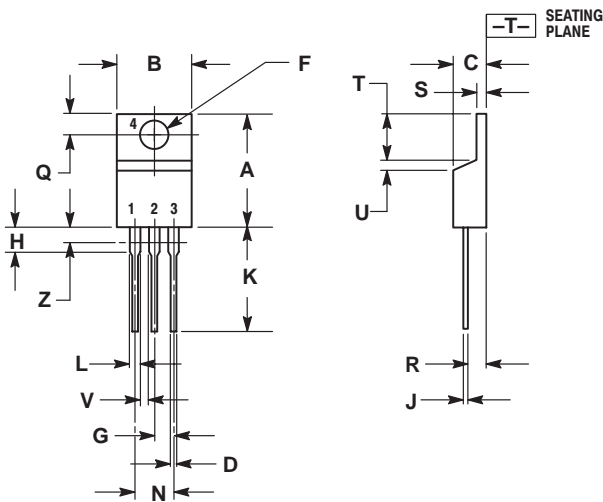

NOTES:  
1. DIMENSIONING AND TOLERANCING PER ANSI Y14.5M, 1982.  
2. CONTROLLING DIMENSION: INCH.  
3. DIMENSION Z DEFINES A ZONE WHERE ALL BODY AND LEAD IRREGULARITIES ARE ALLOWED.

DIM	INCHES		MILLIMETERS	
	MIN	MAX	MIN	MAX
A	0.570	0.620	14.48	15.75
B	0.380	0.405	9.66	10.28
C	0.160	0.190	4.07	4.82
D	0.025	0.035	0.64	0.88
F	0.142	0.147	3.61	3.73
G	0.095	0.105	2.42	2.66
H	0.110	0.155	2.80	3.93
J	0.018	0.025	0.46	0.64
K	0.500	0.562	12.70	14.27
L	0.045	0.060	1.15	1.52
N	0.190	0.210	4.83	5.33
Q	0.100	0.120	2.54	3.04
R	0.080	0.110	2.04	2.79
S	0.045	0.055	1.15	1.39
T	0.235	0.255	5.97	6.47
U	0.000	0.050	0.00	1.27
V	0.045	---	1.15	---
Z	---	0.080	---	2.04

STYLE 1:  
PIN 1. BASE  
2. COLLECTOR  
3. EMITTER  
4. COLLECTOR

STYLE 2:  
PIN 1. BASE  
2. EMITTER  
3. COLLECTOR  
4. EMITTER

STYLE 3:  
PIN 1. CATHODE  
2. ANODE  
3. GATE  
4. ANODE

STYLE 4:  
PIN 1. MAIN TERMINAL 1  
2. MAIN TERMINAL 2  
3. GATE  
4. MAIN TERMINAL 2

STYLE 5:  
PIN 1. GATE  
2. DRAIN  
3. SOURCE  
4. DRAIN

STYLE 6:  
PIN 1. ANODE  
2. CATHODE  
3. ANODE  
4. CATHODE

STYLE 7:  
PIN 1. CATHODE  
2. ANODE  
3. CATHODE  
4. ANODE

STYLE 8:  
PIN 1. CATHODE  
2. ANODE  
3. EXTERNAL TRIP/DELAY  
4. ANODE

STYLE 9:  
PIN 1. GATE  
2. COLLECTOR  
3. EMITTER  
4. COLLECTOR

STYLE 10:  
PIN 1. GATE  
2. SOURCE  
3. DRAIN  
4. SOURCE

STYLE 11:  
PIN 1. DRAIN  
2. SOURCE  
3. GATE  
4. SOURCE

PACKAGE OUTLINE DIMENSIONS (continued)

TO-220 TWO-LEAD  
CASE 221B-04  
ISSUE D

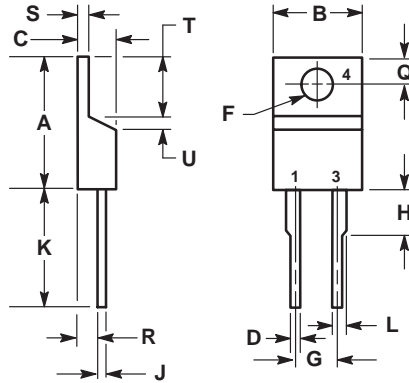

NOTES:  
1. DIMENSIONING AND TOLERANCING PER ANSI Y14.5M, 1982.  
2. CONTROLLING DIMENSION: INCH.

DIM	INCHES		MILLIMETERS	
	MIN	MAX	MIN	MAX
A	0.595	0.620	15.11	15.75
B	0.380	0.405	9.65	10.29
C	0.160	0.190	4.06	4.82
D	0.025	0.035	0.64	0.89
F	0.142	0.147	3.61	3.73
G	0.190	0.210	4.83	5.33
H	0.110	0.130	2.79	3.30
J	0.018	0.025	0.46	0.64
K	0.500	0.562	12.70	14.27
L	0.045	0.060	1.14	1.52
Q	0.100	0.120	2.54	3.04
R	0.080	0.110	2.04	2.79
S	0.045	0.055	1.14	1.39
T	0.235	0.255	5.97	6.48
U	0.000	0.050	0.00	1.27

STYLE 1:  
PIN 1. CATHODE  
2. N/A  
3. ANODE  
4. CATHODE

STYLE 2:  
PIN 1. ANODE  
2. N/A  
3. CATHODE  
4. ANODE

TO-220 FULLPACK TRANSISTOR  
CASE 221D-02  
ISSUE D

SCALE 1:1

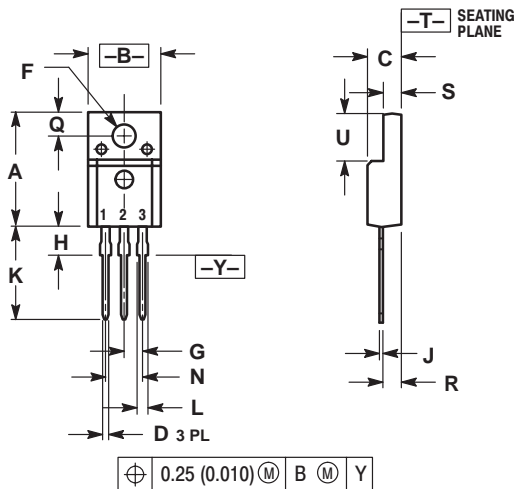

NOTES:  
1. DIMENSIONING AND TOLERANCING PER ANSI Y14.5M, 1982.  
2. CONTROLLING DIMENSION: INCH.

DIM	INCHES		MILLIMETERS	
	MIN	MAX	MIN	MAX
A	0.621	0.629	15.78	15.97
B	0.394	0.402	10.01	10.21
C	0.181	0.189	4.60	4.80
D	0.026	0.034	0.67	0.86
F	0.121	0.129	3.08	3.27
G	0.100	BSC	2.54	BSC
H	0.123	0.129	3.13	3.27
J	0.018	0.025	0.46	0.64
K	0.500	0.562	12.70	14.27
L	0.045	0.060	1.14	1.52
N	0.200	BSC	5.08	BSC
Q	0.126	0.134	3.21	3.40
R	0.107	0.111	2.72	2.81
S	0.096	0.104	2.44	2.64
U	0.259	0.267	6.58	6.78

STYLE 1:  
PIN 1. GATE  
2. DRAIN  
3. SOURCE

STYLE 2:  
PIN 1. BASE  
2. COLLECTOR  
3. EMITTER

STYLE 3:  
PIN 1. ANODE  
2. CATHODE  
3. ANODE

STYLE 4:  
PIN 1. CATHODE  
2. ANODE  
3. CATHODE

STYLE 5:  
PIN 1. CATHODE  
2. ANODE  
3. GATE

STYLE 6:  
PIN 1. MT 1  
2. MT 2  
3. GATE

PACKAGE OUTLINE DIMENSIONS (continued)

AXIAL LEAD  
CASE 267-03  
ISSUE G

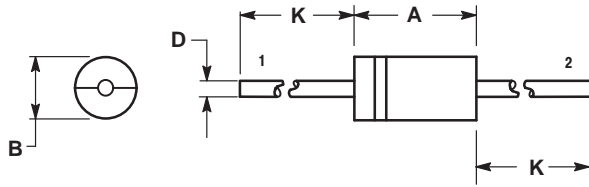

- NOTES:  
1. DIMENSIONING AND TOLERANCING PER ANSI Y14.5M, 1982.  
2. CONTROLLING DIMENSION: INCH.

DIM	INCHES		MILLIMETERS	
	MIN	MAX	MIN	MAX
A	0.370	0.380	9.40	9.65
B	0.190	0.210	4.83	5.33
D	0.048	0.052	1.22	1.32
K	1.000	---	25.40	---

STYLE 1:  
PIN 1. CATHODE (POLARITY BAND)  
2. ANODE

STYLE 2:  
NO POLARITY

AXIAL LEAD  
CASE 267-05  
ISSUE G

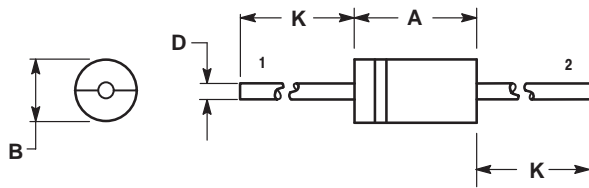

- NOTES:  
1. DIMENSIONING AND TOLERANCING PER ANSI Y14.5M, 1982.  
2. CONTROLLING DIMENSION: INCH.

DIM	INCHES		MILLIMETERS	
	MIN	MAX	MIN	MAX
A	0.287	0.374	7.30	9.50
B	0.189	0.209	4.80	5.30
D	0.047	0.051	1.20	1.30
K	1.000	---	25.40	---

STYLE 1:  
PIN 1. CATHODE (POLARITY BAND)  
2. ANODE

STYLE 2:  
NO POLARITY

PACKAGE OUTLINE DIMENSIONS (continued)

TO-218 THREE LEAD  
TO-218  
CASE 340D-02  
ISSUE B

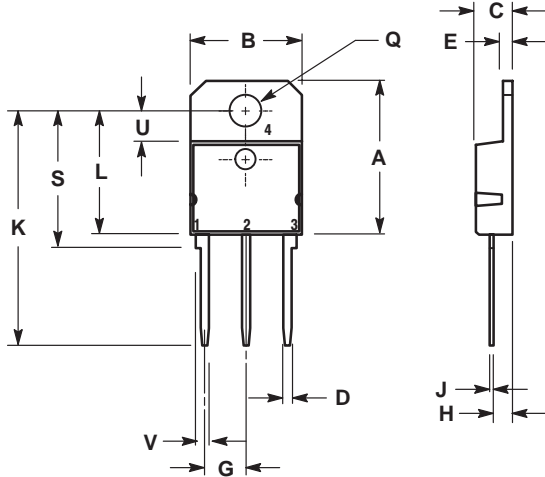

STYLE 1:  
PIN 1. BASE  
2. COLLECTOR  
3. EMITTER  
4. COLLECTOR

STYLE 2:  
PIN 1. ANODE  
2. CATHODE  
3. ANODE  
4. CATHODE

NOTES:  
1. DIMENSIONING AND TOLERANCING PER ANSI Y14.5M, 1982.  
2. CONTROLLING DIMENSION: MILLIMETER.

DIM	MILLIMETERS		INCHES	
	MIN	MAX	MIN	MAX
A	---	20.35	---	0.801
B	14.70	15.20	0.579	0.598
C	4.70	4.90	0.185	0.193
D	1.10	1.30	0.043	0.051
E	1.17	1.37	0.046	0.054
G	5.40	5.55	0.213	0.219
H	2.00	3.00	0.079	0.118
J	0.50	0.78	0.020	0.031
K	31.00 REF		1.220 REF	
L	---	16.20	---	0.638
Q	4.00	4.10	0.158	0.161
S	17.80	18.20	0.701	0.717
U	4.00 REF		0.157 REF	
V	1.75 REF		0.069	

TO-218 TWO LEAD  
TO-218  
CASE 340E-02  
ISSUE A

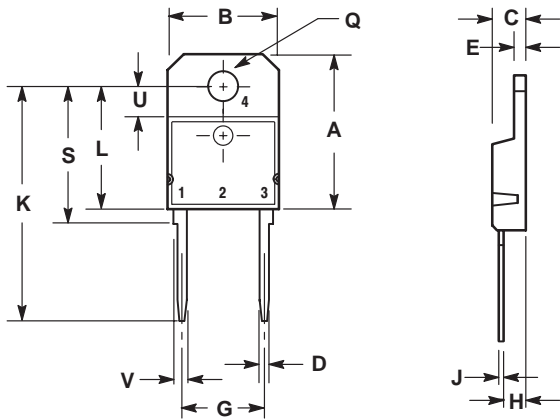

NOTES:  
1. DIMENSIONING AND TOLERANCING PER ANSI Y14.5M, 1982.  
2. CONTROLLING DIMENSION: MILLIMETER.

DIM	MILLIMETERS		INCHES	
	MIN	MAX	MIN	MAX
A	---	20.35	---	0.801
B	14.70	15.20	0.579	0.598
C	4.70	4.90	0.185	0.193
D	1.10	1.30	0.043	0.051
E	1.17	1.37	0.046	0.054
G	10.80	11.10	0.425	0.437
H	2.00	3.00	0.079	0.118
J	0.50	0.78	0.020	0.031
K	31.00 REF		1.220 REF	
L	---	16.20	---	0.638
Q	4.00	4.10	0.158	0.161
S	17.80	18.20	0.701	0.717
U	4.00 REF		0.157 REF	
V	1.75 REF		0.069	

STYLE 1:  
PIN 1. CATHODE  
3. ANODE  
4. CATHODE

PACKAGE OUTLINE DIMENSIONS (continued)

TO-247  
CASE 340L-02  
ISSUE D

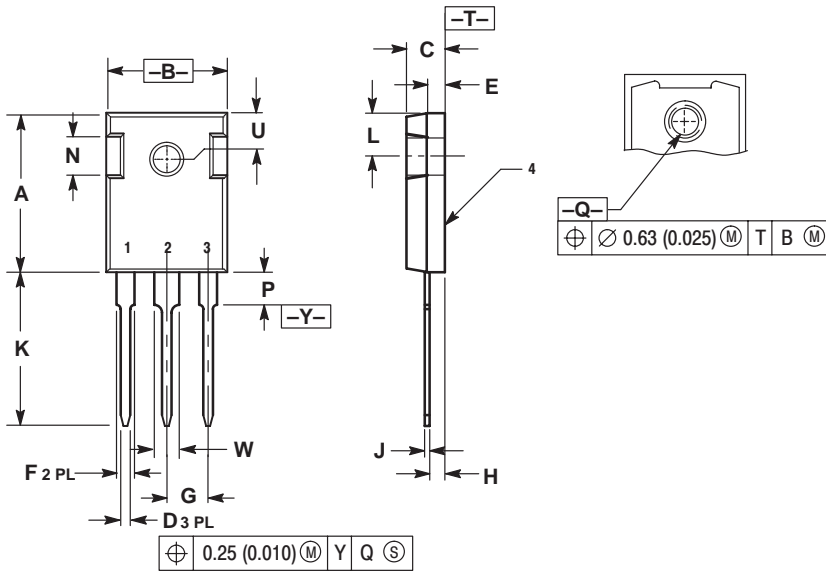

- NOTES:  
1. DIMENSIONING AND TOLERANCING PER ANSI Y14.5M, 1982.  
2. CONTROLLING DIMENSION: MILLIMETER.

DIM	MILLIMETERS		INCHES	
	MIN	MAX	MIN	MAX
A	20.32	21.08	0.800	0.830
B	15.75	16.26	0.620	0.640
C	4.70	5.30	0.185	0.209
D	1.00	1.40	0.040	0.055
E	2.20	2.60	0.087	0.102
F	1.65	2.13	0.065	0.084
G	5.45 BSC		0.215 BSC	
H	1.50	2.49	0.059	0.098
J	0.40	0.80	0.016	0.031
K	20.06	20.83	0.790	0.820
L	5.40	6.20	0.212	0.244
N	4.32	5.49	0.170	0.216
P	---	4.50	---	0.177
Q	3.55	3.65	0.140	0.144
U	6.15 BSC		0.242 BSC	
W	2.87	3.12	0.113	0.123

- |  |   |   |   |
|--|---|---|---|
| STYLE 1:<br>PIN 1. GATE<br>2. DRAIN<br>3. SOURCE<br>4. DRAIN | STYLE 2:<br>PIN 1. ANODE<br>2. CATHODE (S)<br>3. ANODE 2<br>4. CATHODES (S) | STYLE 3:<br>PIN 1. BASE<br>2. COLLECTOR<br>3. EMITTER<br>4. COLLECTOR | STYLE 4:<br>PIN 1. GATE<br>2. COLLECTOR<br>3. EMITTER<br>4. COLLECTOR |
|--|---|---|---|

POWERTAP II  
CASE 357C-03  
ISSUE E

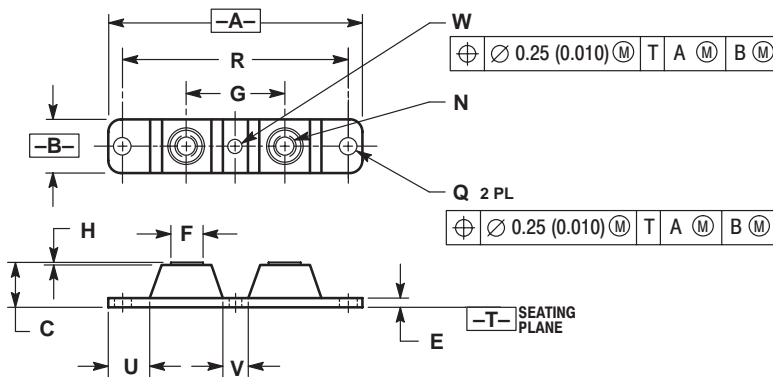

- NOTES:  
1. DIMENSIONING AND TOLERANCING PER ANSI Y14.5M, 1982.  
2. CONTROLLING DIMENSION: INCH.  
3. TERMINAL PENETRATION: 5.97 (0.235) MAXIMUM.

DIM	INCHES		MILLIMETERS	
	MIN	MAX	MIN	MAX
A	3.450	3.635	87.63	92.33
B	0.700	0.810	17.78	20.57
C	0.615	0.640	15.63	16.26
E	0.120	0.130	3.05	3.30
F	0.435	0.445	11.05	11.30
G	1.370	1.380	34.80	35.05
H	0.007	0.030	0.18	0.76
N	1/4-20UNC-2B		1/4-20UNC-2B	
Q	0.270	0.285	6.86	7.23
R	31.50 BSC		80.01 BSC	
U	0.600	0.630	15.24	16.00
V	0.330	0.375	8.39	9.52
W	0.170	0.190	4.32	4.82

PACKAGE OUTLINE DIMENSIONS (continued)

POWERTAP III  
CASE 357D-01  
ISSUE A

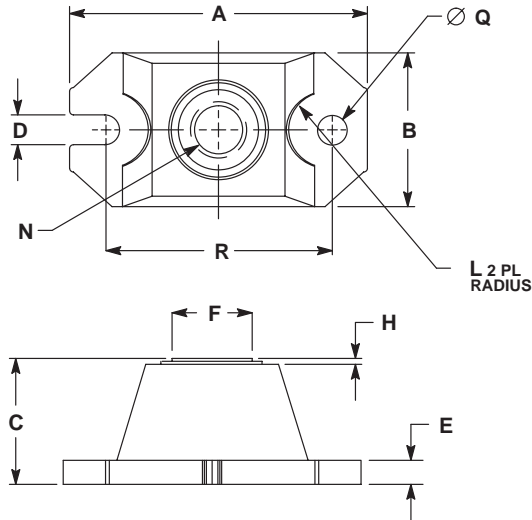

- NOTES:  
1. DIMENSIONING AND TOLERANCING PER ANSI Y14.5M, 1982.  
2. CONTROLLING DIMENSION: INCH.  
3. TERMINAL PENETRATION: 5.97 (0.235) MAXIMUM.

DIM	INCHES		MILLIMETERS	
	MIN	MAX	MIN	MAX
A	1.520	1.560	38.61	39.62
B	0.783	0.813	19.89	20.65
C	0.615	0.635	15.62	16.13
D	0.152	0.162	3.86	4.11
E	0.120	0.130	3.05	3.30
F	0.435	0.445	11.05	11.30
H	0.007	0.030	0.18	0.76
L	0.210	0.230	5.33	5.84
N	1/4-20UNC-2B	1/4-20UNC-2B		
Q	0.152	0.162	3.86	4.11
R	1.175	1.195	29.85	30.35

DPAK  
CASE 369A-13  
ISSUE AA

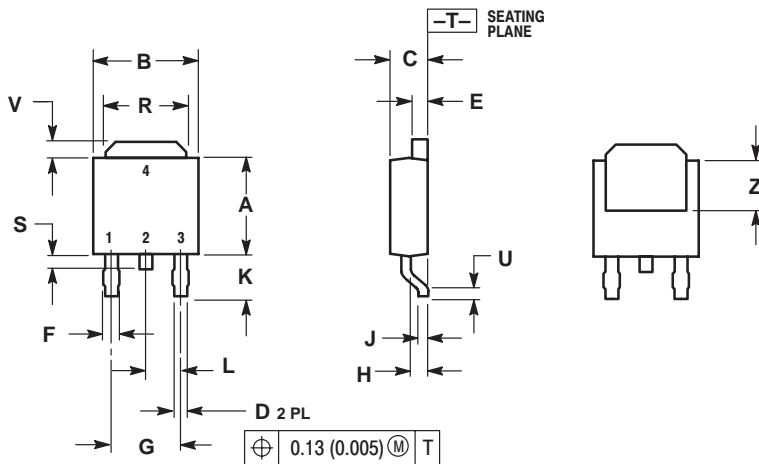

- NOTES:  
1. DIMENSIONING AND TOLERANCING PER ANSI Y14.5M, 1982.  
2. CONTROLLING DIMENSION: INCH.

DIM	INCHES		MILLIMETERS	
	MIN	MAX	MIN	MAX
A	0.235	0.250	5.97	6.35
B	0.250	0.265	6.35	6.73
C	0.086	0.094	2.19	2.38
D	0.027	0.035	0.69	0.88
E	0.033	0.040	0.84	1.01
F	0.037	0.047	0.94	1.19
G	0.180 BSC		4.58 BSC	
H	0.034	0.040	0.87	1.01
J	0.018	0.023	0.46	0.58
K	0.102	0.114	2.60	2.89
L	0.090 BSC		2.29 BSC	
R	0.175	0.215	4.45	5.46
S	0.020	0.050	0.51	1.27
U	0.020	---	0.51	---
V	0.030	0.050	0.77	1.27
Z	0.138	---	3.51	---

STYLE 1:  
PIN 1. BASE  
2. COLLECTOR  
3. EMITTER  
4. COLLECTOR

STYLE 2:  
PIN 1. GATE  
2. DRAIN  
3. SOURCE  
4. DRAIN

STYLE 3:  
PIN 1. ANODE  
2. CATHODE  
3. ANODE  
4. CATHODE

STYLE 4:  
PIN 1. CATHODE  
2. ANODE  
3. GATE  
4. ANODE

STYLE 5:  
PIN 1. GATE  
2. ANODE  
3. CATHODE  
4. ANODE

STYLE 6:  
PIN 1. MT1  
2. MT2  
3. GATE  
4. MT2

PACKAGE OUTLINE DIMENSIONS (continued)

**SMC**  
CASE 403-03  
ISSUE B

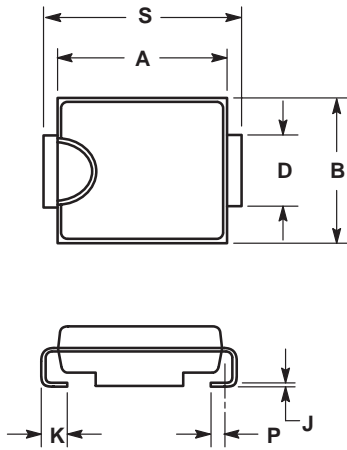

- NOTES:
1. DIMENSIONING AND TOLERANCING PER ANSI Y14.5M, 1982.
  2. CONTROLLING DIMENSION: INCH.
  3. D DIMENSION SHALL BE MEASURED WITHIN DIMENSION P.

DIM	INCHES		MILLIMETERS	
	MIN	MAX	MIN	MAX
A	0.260	0.280	6.60	7.11
B	0.220	0.240	5.59	6.10
C	0.075	0.095	1.90	2.41
D	0.115	0.121	2.92	3.07
H	0.0020	0.0060	0.051	0.152
J	0.006	0.012	0.15	0.30
K	0.030	0.050	0.76	1.27
P	0.020 REF		0.51 REF	
S	0.305	0.320	7.75	8.13

**SMB**  
D0-214AA  
CASE 403A-03  
ISSUE D

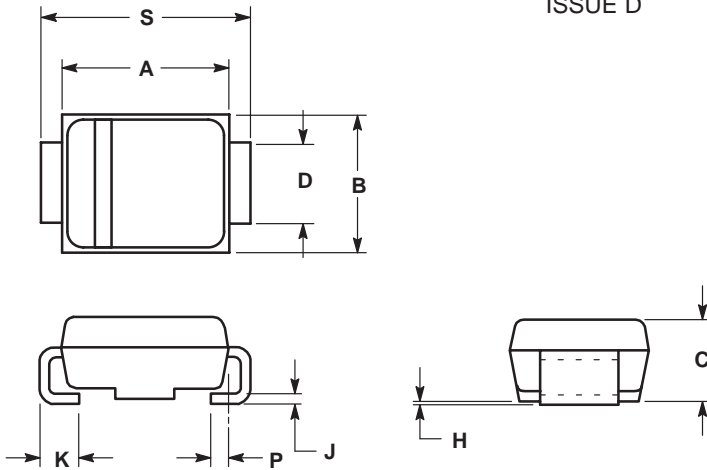

- NOTES:
1. DIMENSIONING AND TOLERANCING PER ANSI Y14.5M, 1982.
  2. CONTROLLING DIMENSION: INCH.
  3. D DIMENSION SHALL BE MEASURED WITHIN DIMENSION P.

DIM	INCHES		MILLIMETERS	
	MIN	MAX	MIN	MAX
A	0.160	0.180	4.06	4.57
B	0.130	0.150	3.30	3.81
C	0.075	0.095	1.90	2.41
D	0.077	0.083	1.96	2.11
H	0.0020	0.0060	0.051	0.152
J	0.006	0.012	0.15	0.30
K	0.030	0.050	0.76	1.27
P	0.020 REF		0.51 REF	
S	0.205	0.220	5.21	5.59



PACKAGE OUTLINE DIMENSIONS (continued)

**SMB**  
CASE 403B-01  
ISSUE O

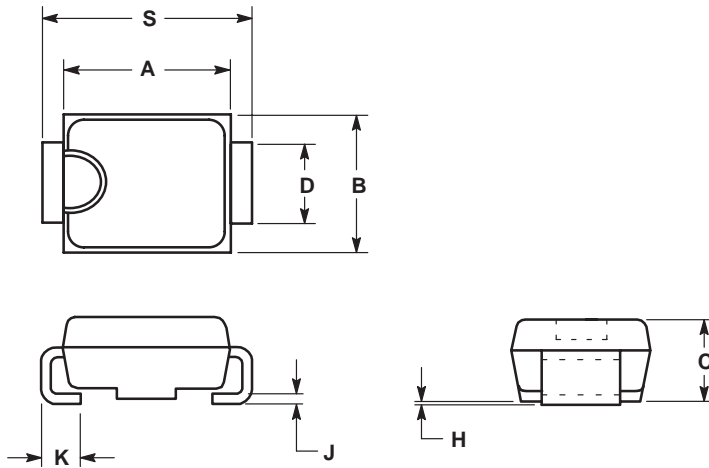

- NOTES:  
1. DIMENSIONING AND TOLERANCING PER ANSI Y14.5M, 1982.  
2. CONTROLLING DIMENSION: INCH.

DIM	INCHES		MILLIMETERS	
	MIN	MAX	MIN	MAX
A	0.160	0.180	4.06	4.57
B	0.090	0.115	2.29	2.92
C	0.075	0.105	1.91	2.67
D	0.050	0.064	1.27	1.63
H	0.004	0.008	0.10	0.20
J	0.006	0.016	0.15	0.41
K	0.030	0.060	0.76	1.52
S	0.190	0.220	4.83	5.59

**D<sup>2</sup>PAK**  
CASE 418B-03  
ISSUE D

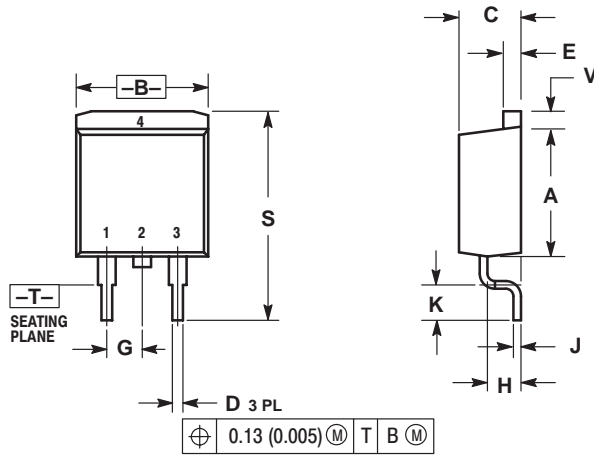

- NOTES:  
1. DIMENSIONING AND TOLERANCING PER ANSI Y14.5M, 1982.  
2. CONTROLLING DIMENSION: INCH.

DIM	INCHES		MILLIMETERS	
	MIN	MAX	MIN	MAX
A	0.340	0.380	8.64	9.65
B	0.380	0.405	9.65	10.29
C	0.160	0.190	4.06	4.83
D	0.020	0.035	0.51	0.89
E	0.045	0.055	1.14	1.40
G	0.100 BSC		2.54 BSC	
H	0.080	0.110	2.03	2.79
J	0.018	0.025	0.46	0.64
K	0.090	0.110	2.29	2.79
S	0.575	0.625	14.60	15.88
V	0.045	0.055	1.14	1.40

STYLE 1:  
PIN 1. BASE  
2. COLLECTOR  
3. EMITTER  
4. COLLECTOR

STYLE 2:  
PIN 1. GATE  
2. DRAIN  
3. SOURCE  
4. DRAIN

STYLE 3:  
PIN 1. ANODE  
2. CATHODE  
3. ANODE  
4. CATHODE

# Leadform Options — TO-220 (Case 221A)

- Leadform options require assignment of a special part number before ordering.
- Contact your local ON Semiconductor representative for special part number and pricing.
- 10,000 piece minimum quantity orders are required.
- Leadform orders are non-cancellable after processing.
- Leadforms apply to both ON Semiconductor Case 221A-04 and 221A-06 except as noted.

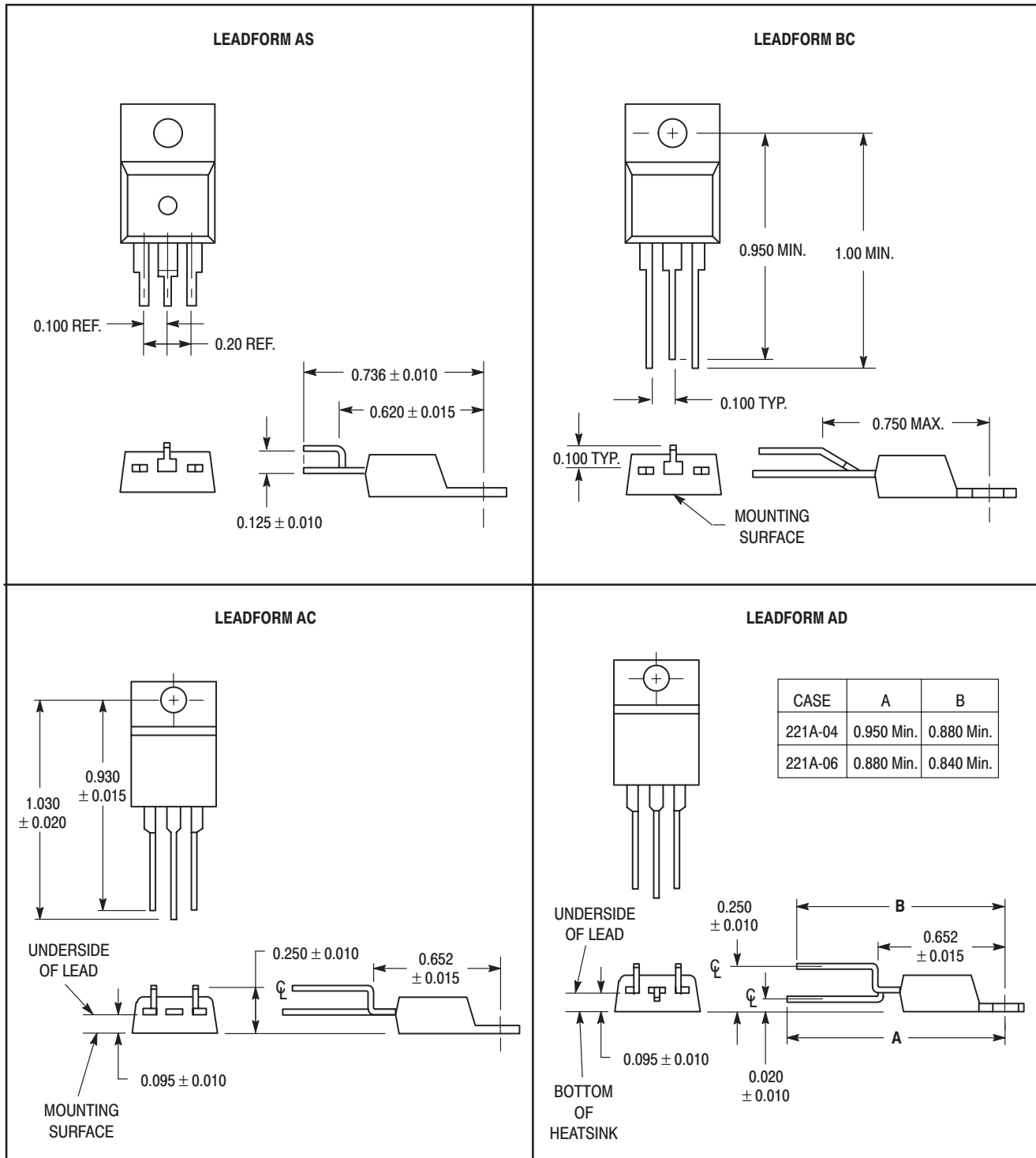

# TO-220 Leadform Options (continued)

**LEADFORM AN**

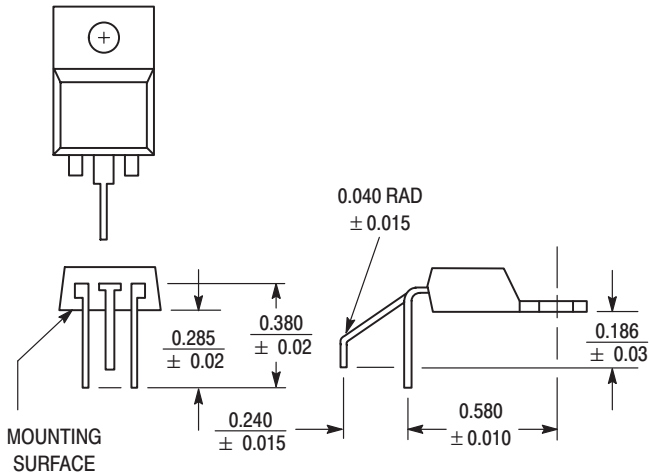

**LEADFORM BA**

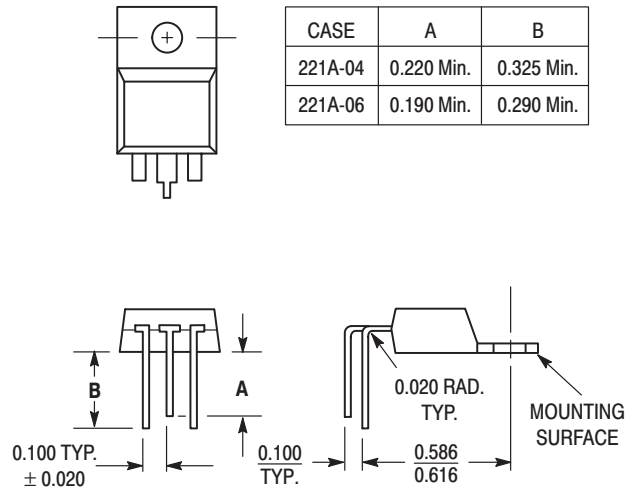

**LEADFORM BL**

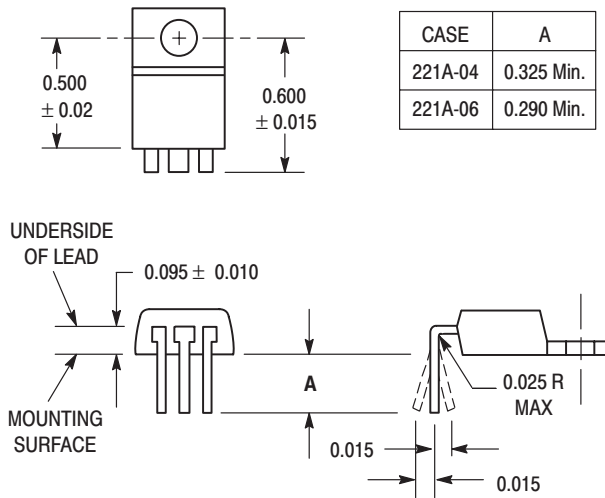

**LEADFORM AK**

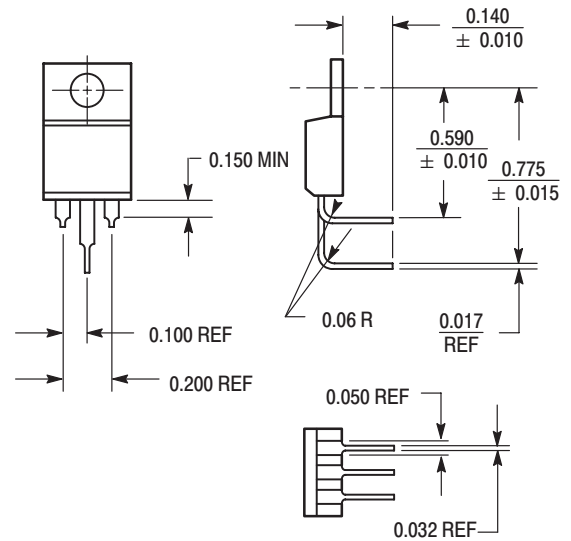

# TO-220 Leadform Options (continued)

**LEADFORM AF**

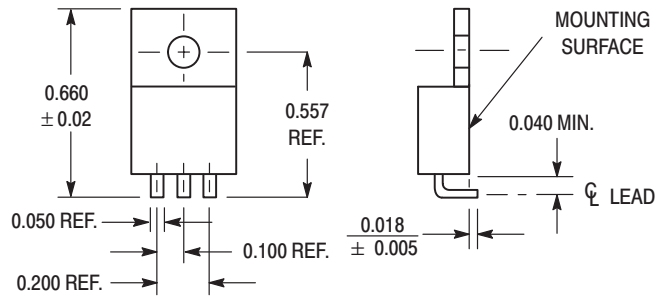

**LEADFORM BS**

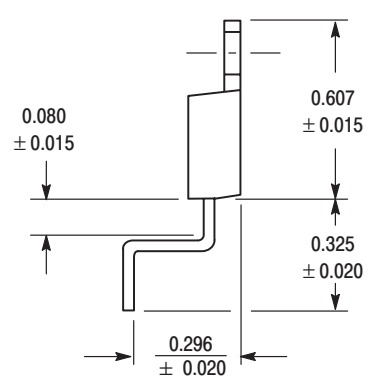

**LEADFORM BR**

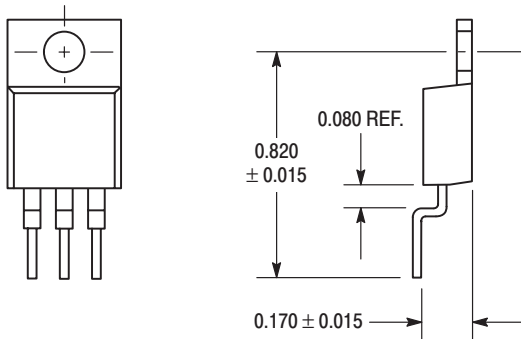

**LEADFORM AU**

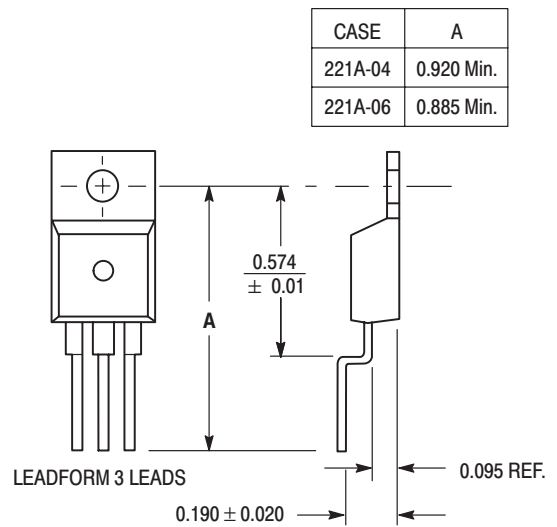

# TO-220 Leadform Options (continued)

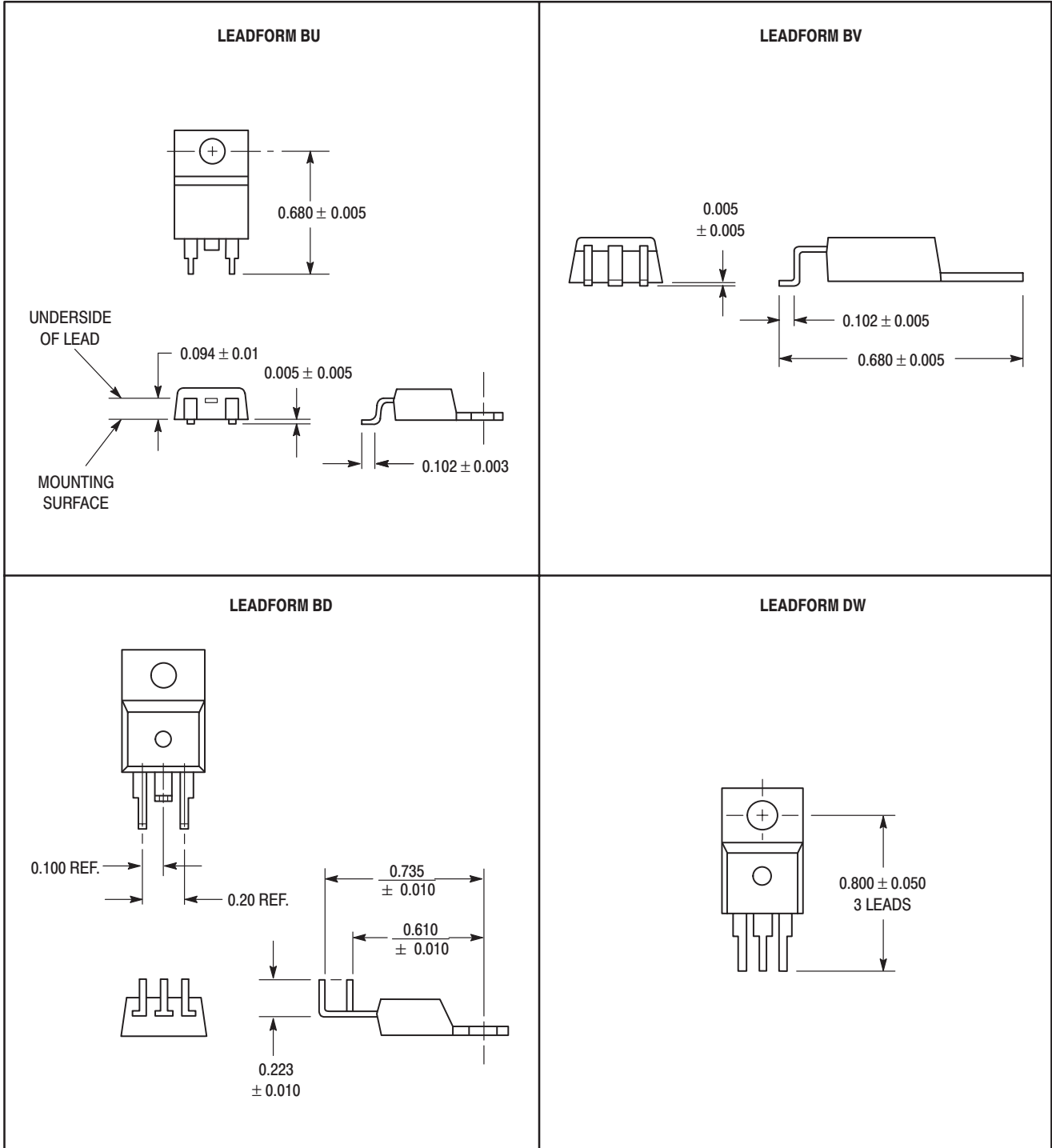

# TO-220 Leadform Options (continued)

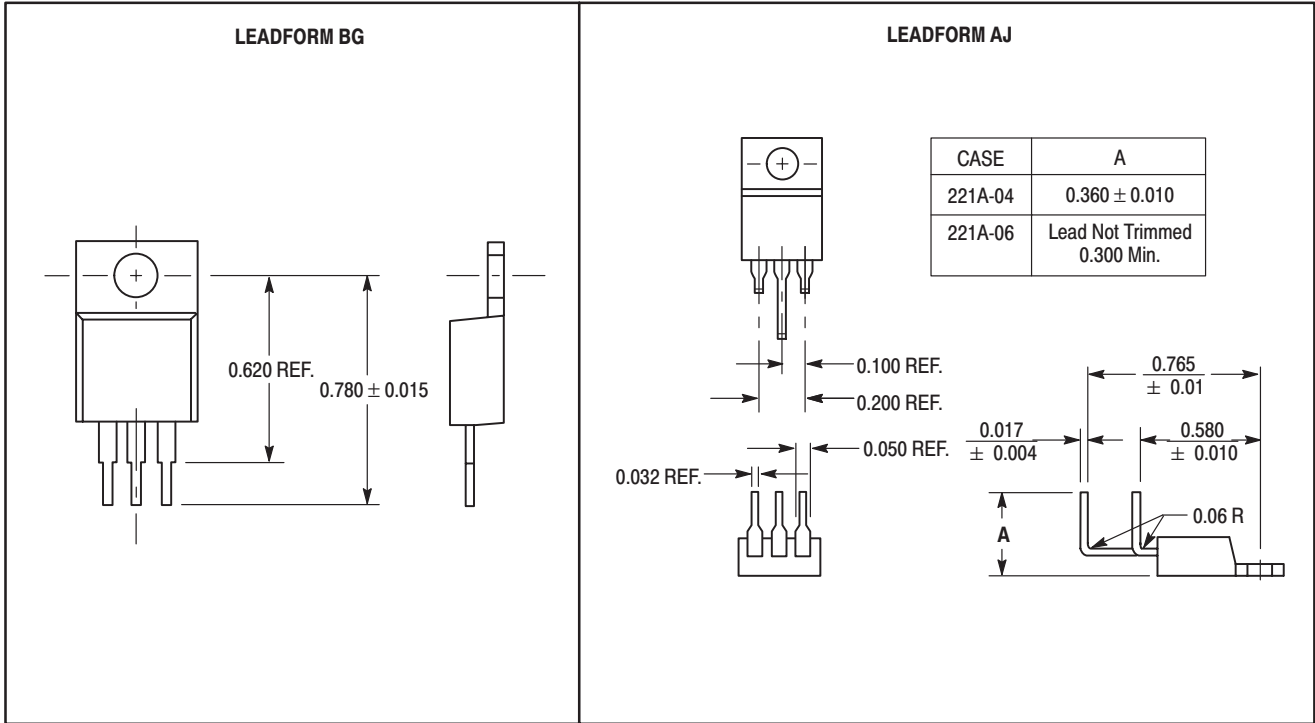

# INFORMATION FOR USING SURFACE MOUNT PACKAGES

## RECOMMENDED FOOTPRINTS FOR SURFACE MOUNTED APPLICATIONS

Surface mount board layout is a critical portion of the total design. The footprint for the semiconductor packages must be the correct size to ensure proper solder connection

interface between the board and the package. With the correct pad geometry, the packages will self align when subjected to a solder reflow process.

### POWER DISSIPATION FOR A SURFACE MOUNT DEVICE

The power dissipation for a surface mount device is a function of the drain/collector pad size. These can vary from the minimum pad size for soldering to a pad size given for maximum power dissipation. Power dissipation for a surface mount device is determined by  $T_{J(max)}$ , the maximum rated junction temperature of the die,  $R_{\theta JA}$ , the thermal resistance from the device junction to ambient, and the operating temperature,  $T_A$ . Using the values provided on the data sheet,  $P_D$  can be calculated as follows:

$$P_D = \frac{T_{J(max)} - T_A}{R_{\theta JA}}$$

The values for the equation are found in the maximum ratings table on the data sheet. Substituting these values into the equation for an ambient temperature  $T_A$  of 25°C, one can calculate the power dissipation of the device. For example, for a SOT-223 device,  $P_D$  is calculated as follows.

$$P_D = \frac{150^\circ\text{C} - 25^\circ\text{C}}{156^\circ\text{C/W}} = 800 \text{ milliwatts}$$

The 156°C/W for the SOT-223 package assumes the use of the recommended footprint on a glass epoxy printed circuit board to achieve a power dissipation of 800 milliwatts. There are other alternatives to achieving higher power dissipation from the surface mount packages. One is to increase the area of the drain/collector pad. By increasing the area of the drain/collector pad, the power dissipation can be increased. Although the power dissipation can almost be doubled with this method, area is taken up on the printed circuit board which can defeat the purpose of using surface mount technology. For example, a graph of  $R_{\theta JA}$  versus drain pad area is shown in Figures 1, 2 and 3.

Another alternative would be to use a ceramic substrate or an aluminum core board such as Thermal Clad™. Using a board material such as Thermal Clad, an aluminum core board, the power dissipation can be doubled using the same footprint.

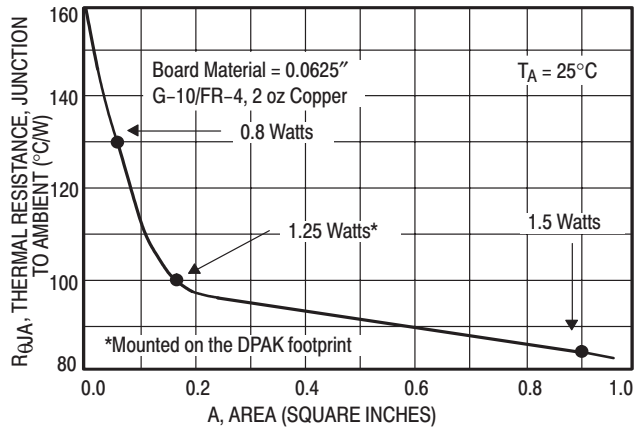

Figure 1. Thermal Resistance versus Drain Pad Area for the SOT-223 Package (Typical)

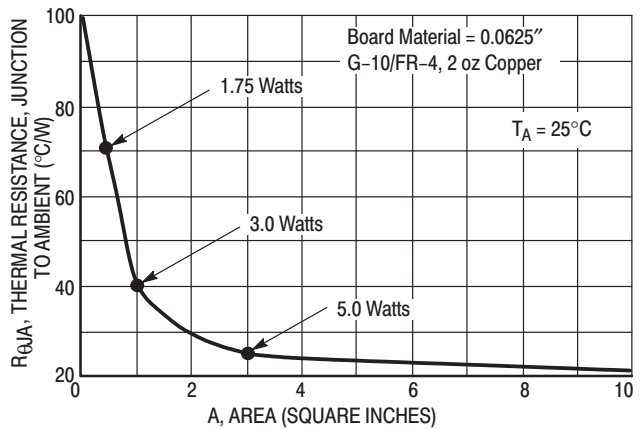

Figure 2. Thermal Resistance versus Drain Pad Area for the DPAK Package (Typical)

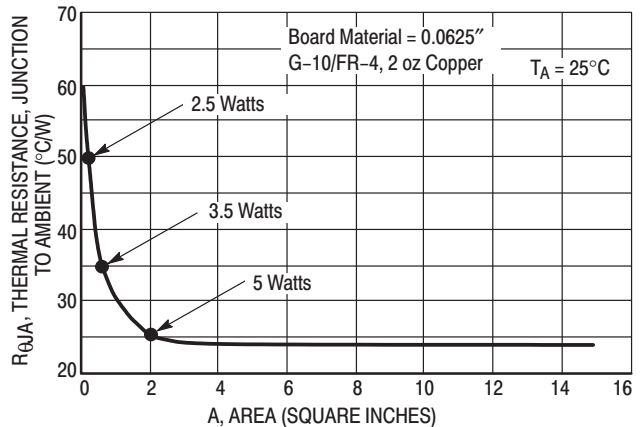

Figure 3. Thermal Resistance versus Drain Pad Area for the D²PAK Package (Typical)

## SOLDER STENCIL GUIDELINES

Prior to placing surface mount components onto a printed circuit board, solder paste must be applied to the pads. Solder stencils are used to screen the optimum amount. These stencils are typically 0.008 inches thick and may be made of brass or stainless steel. For packages such as the SC-59, SC-70/SOT-323, SOD-123, SOT-23, SOT-143, SOT-223, SO-8, SO-14, SO-16, and SMB/SMC diode packages, the stencil opening should be the same as the pad size or a 1:1 registration. This is not the case with the DPAK and D<sup>2</sup>PAK packages. If a 1:1 opening is used to screen solder onto the drain pad, misalignment and/or “tombstoning” may occur due to an excess of solder. For these two packages, the opening in the stencil for the paste should be approximately 50% of the tab area. The opening for the leads is still a 1:1 registration. Figure 4 shows a typical stencil for the DPAK and D<sup>2</sup>PAK packages. The

pattern of the opening in the stencil for the drain pad is not critical as long as it allows approximately 50% of the pad to be covered with paste.

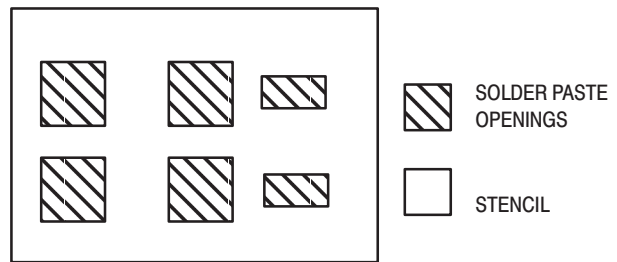

Figure 4. Typical Stencil for DPAK and D<sup>2</sup>PAK Packages

## SOLDERING PRECAUTIONS

The melting temperature of solder is higher than the rated temperature of the device. When the entire device is heated to a high temperature, failure to complete soldering within a short time could result in device failure. Therefore, the following items should always be observed in order to minimize the thermal stress to which the devices are subjected.

- Always preheat the device.
- The delta temperature between the preheat and soldering should be 100°C or less.\*
- When preheating and soldering, the temperature of the leads and the case must not exceed the maximum temperature ratings as shown on the data sheet. When using infrared heating with the reflow soldering method, the difference should be a maximum of 10°C.
- The soldering temperature and time should not exceed 260°C for more than 10 seconds.
- When shifting from preheating to soldering, the maximum temperature gradient shall be 5°C or less.

- After soldering has been completed, the device should be allowed to cool naturally for at least three minutes. Gradual cooling should be used since the use of forced cooling will increase the temperature gradient and will result in latent failure due to mechanical stress.
- Mechanical stress or shock should not be applied during cooling.

\* Soldering a device without preheating can cause excessive thermal shock and stress which can result in damage to the device.

\* Due to shadowing and the inability to set the wave height to incorporate other surface mount components, the D<sup>2</sup>PAK is not recommended for wave soldering.



## TYPICAL SOLDER HEATING PROFILE

For any given circuit board, there will be a group of control settings that will give the desired heat pattern. The operator must set temperatures for several heating zones and a figure for belt speed. Taken together, these control settings make up a heating “profile” for that particular circuit board. On machines controlled by a computer, the computer remembers these profiles from one operating session to the next. Figure 5 shows a typical heating profile for use when soldering a surface mount device to a printed circuit board. This profile will vary among soldering systems, but it is a good starting point. Factors that can affect the profile include the type of soldering system in use, density and types of components on the board, type of solder used, and the type of board or substrate material being used. This profile shows temperature versus time. The line on the graph shows the

actual temperature that might be experienced on the surface of a test board at or near a central solder joint. The two profiles are based on a high density and a low density board. The Vitronics SMD310 convection/infrared reflow soldering system was used to generate this profile. The type of solder used was 62/36/2 Tin Lead Silver with a melting point between 177–189°C. When this type of furnace is used for solder reflow work, the circuit boards and solder joints tend to heat first. The components on the board are then heated by conduction. The circuit board, because it has a large surface area, absorbs the thermal energy more efficiently, then distributes this energy to the components. Because of this effect, the main body of a component may be up to 30 degrees cooler than the adjacent solder joints.

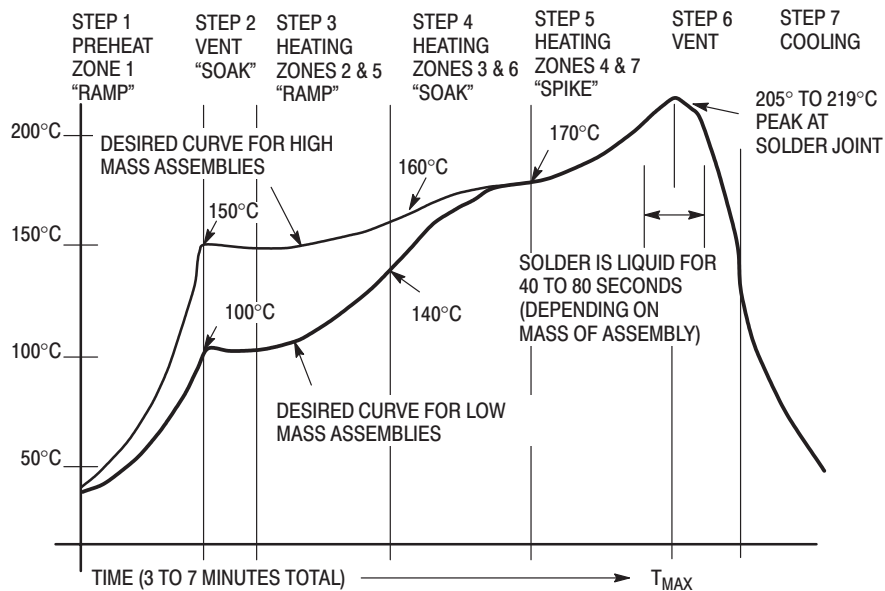
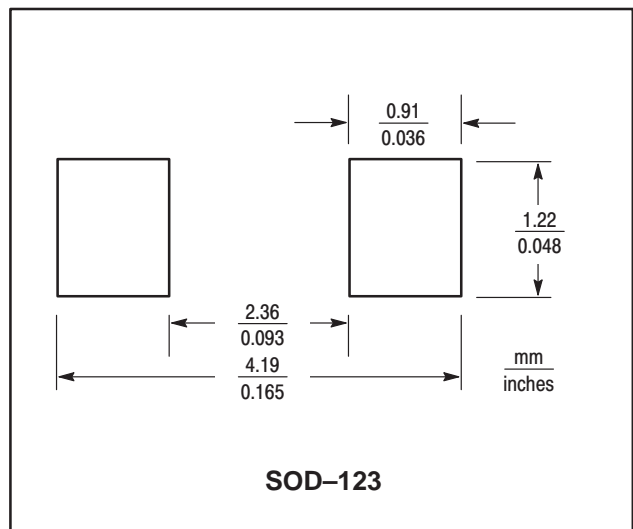
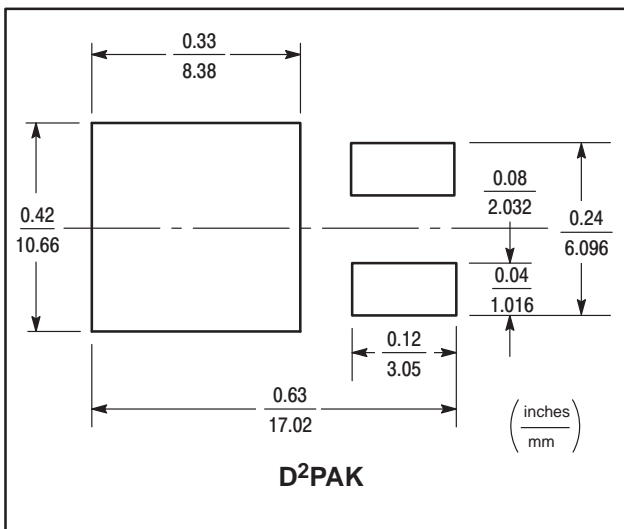
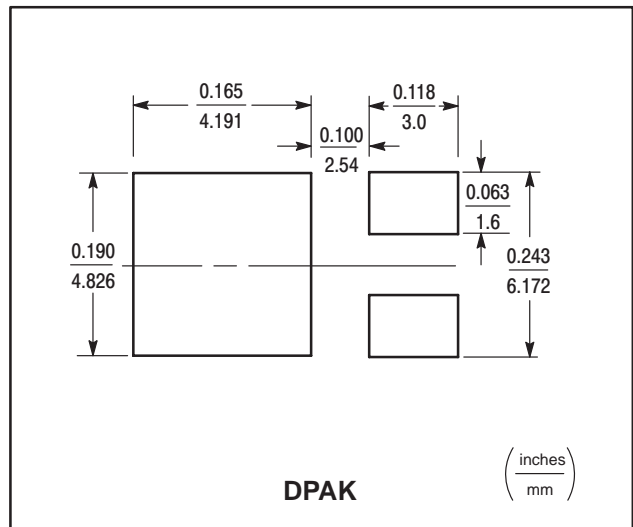
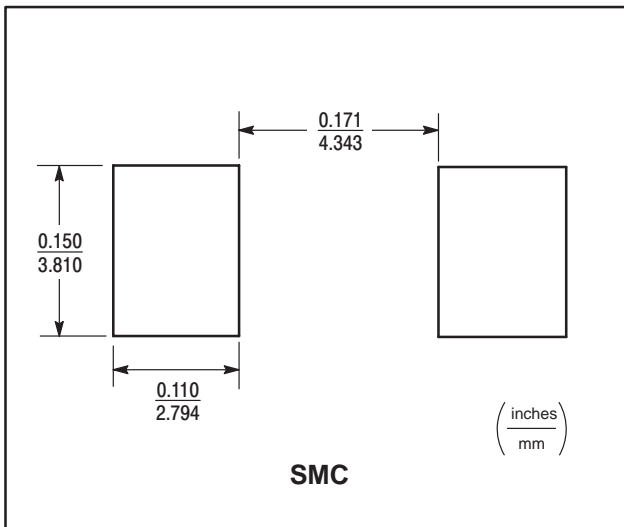
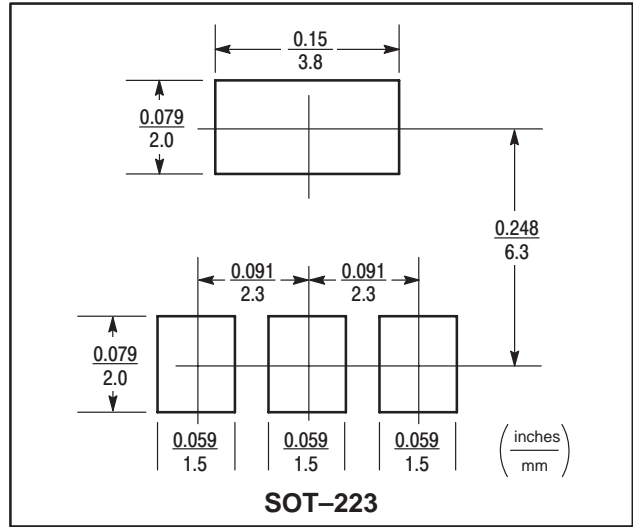
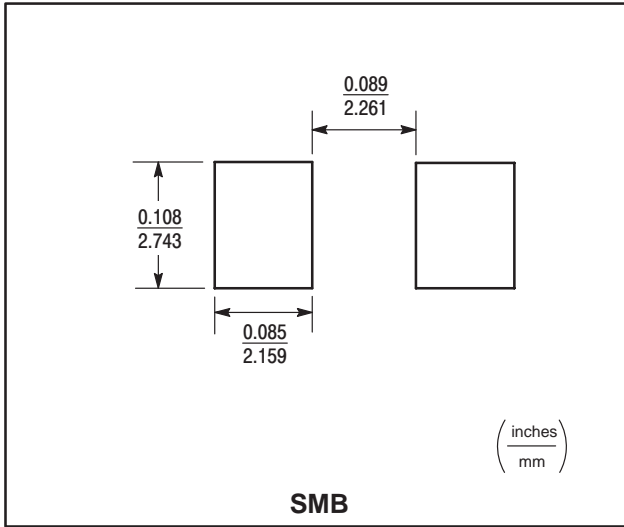
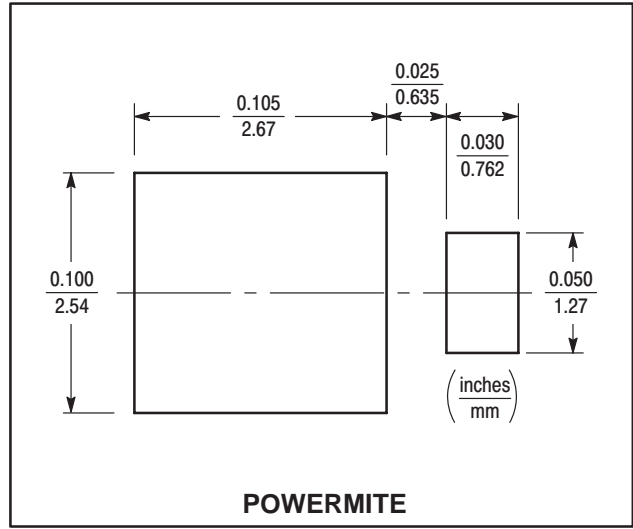
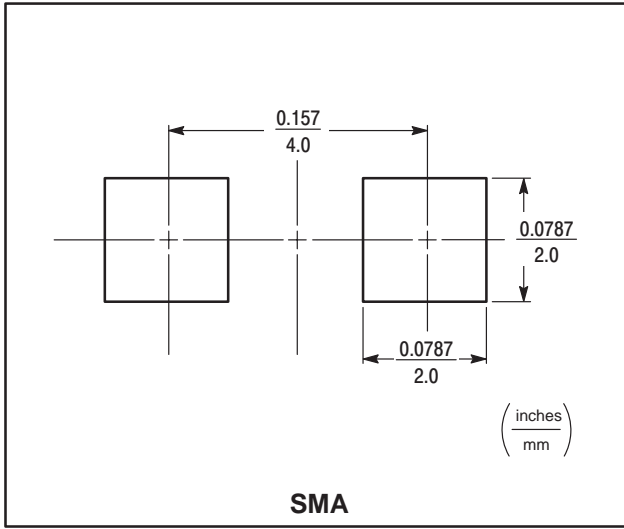

Figure 5. Typical Solder Heating Profile

# Footprints for Soldering



# Footprints for Soldering



# Tape and Reel Specifications and Packaging Specifications

Embossed Tape and Reel is used to facilitate automatic pick and place equipment feed requirements. The tape is used as the shipping container for various products and requires a minimum of handling. The antistatic/conductive tape provides a secure cavity for the product when sealed with the “peel-back” cover tape.

- Two Reel Sizes Available (7" and 13")
- Used for Automatic Pick and Place Feed Systems
- Minimizes Product Handling
- EIA 481, -1, -2
- SOD-123 in 8 mm Tape
- SMB in 12 mm Tape
- DPAK, SMC in 16 mm Tape
- D<sup>2</sup>PAK in 24 mm Tape

Use the standard device title and add the required suffix as listed in the option table on the following page. Note that the individual reels have a finite number of devices depending on the type of product contained in the tape. Also note the minimum lot size is one full reel for each line item, and orders are required to be in increments of the single reel quantity.

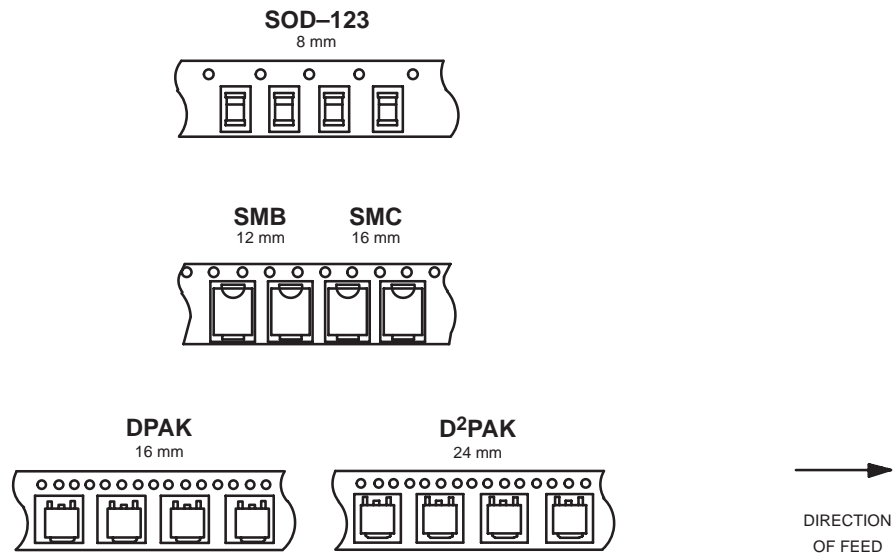

## EMBOSSED TAPE AND REEL ORDERING INFORMATION

Package	Tape Width (mm)	Pitch mm (inch)	Reel Size mm (inch)	Devices Per Reel and Minimum Order Quantity	Device Suffix
DPAK	16	8.0 ± 0.1 (.315 ± .004)	330 (13)	2,500	T4
D <sup>2</sup> PAK	24	16.0 ± 0.1 (.630 ± .004)	330 (13)	800	T4
SMB	12	8.0 ± 0.1 (.315 ± .004)	330 (13)	2,500	T3
SMC	16	8.0 ± 0.1 (.315 ± .004)	330 (13)	2,500	T3
SOD-123	8	4.0 ± 0.1 (.157 ± .004)	178 (7)	3,000	T1
	8		330 (13)	10,000	T3

# EMBOSSED TAPE AND REEL DATA FOR DISCRETES

## CARRIER TAPE SPECIFICATIONS

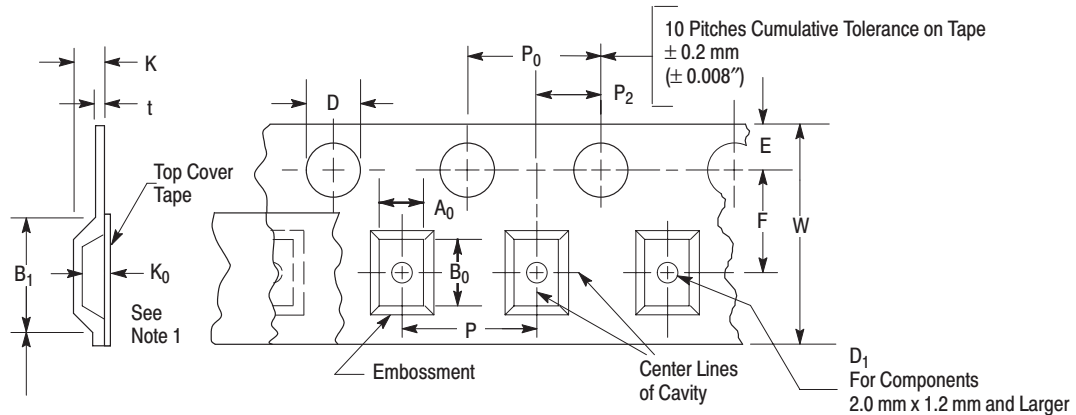

For Machine Reference Only  
Including Draft and RADII  
Concentric Around  $B_0$

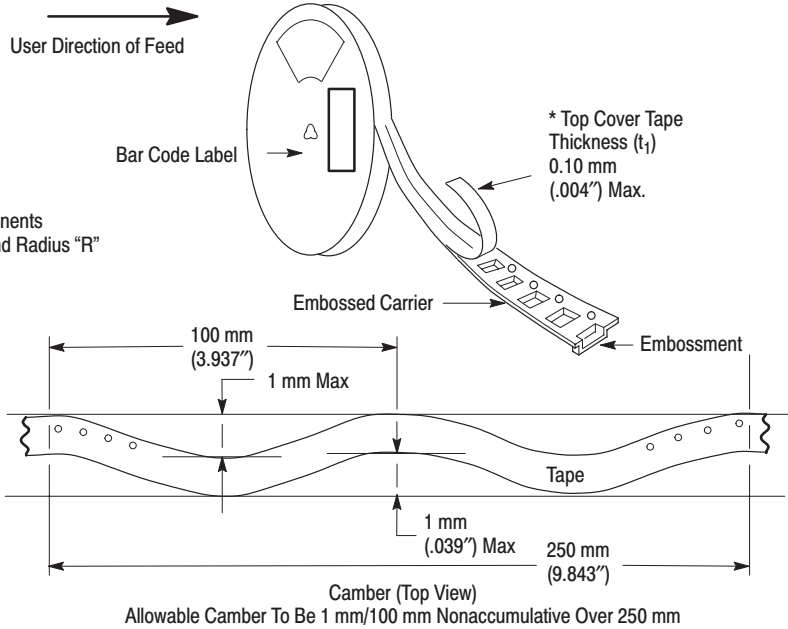
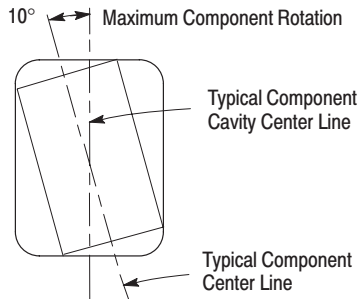
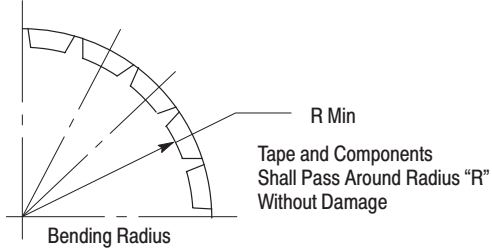

### DIMENSIONS

Tape Size	$B_1$ Max	D	$D_1$	E	F	K	$P_0$	$P_2$	R Min	T Max	W Max
8 mm	4.55 mm (.179")	1.5+0.1 mm -0.0 (.059+ .004" -0.0)	1.0 Min (.039")	1.75±0.1 mm (.069±.004")	3.5±0.05 mm (.138±.002")	2.4 mm Max (.094")	4.0±0.1 mm (.157±.004")	2.0±0.1 mm (.079±.002")	25 mm (.98")	0.6 mm (.024")	8.3 mm (.327")
12 mm	8.2 mm (.323")		1.5 mm Min (.060")		5.5±0.05 mm (.217±.002")	6.4 mm Max (.252")					12±.30 mm (.470±.012")
16 mm	12.1 mm (.476")				7.5±0.10 mm (.295±.004")	7.9 mm Max (.311")					16.3 mm (.642")
24 mm	20.1 mm (.791")				11.5±0.1 mm (.453±.004")	11.9 mm Max (.468")					24.3 mm (.957")

Metric dimensions govern — English are in parentheses for reference only.

NOTE 1:  $A_0$ ,  $B_0$ , and  $K_0$  are determined by component size. The clearance between the components and the cavity must be within .05 mm min. to .50 mm max.,

the component cannot rotate more than 10° within the determined cavity.

NOTE 2: If  $B_1$  exceeds 4.2 mm (.165) for 8 mm embossed tape, the tape may not feed through all tape feeders.

NOTE 3: Pitch information is contained in the Embossed Tape and Reel Ordering Information on pg. 6-3.

## EMBOSSED TAPE AND REEL DATA FOR DISCRETES

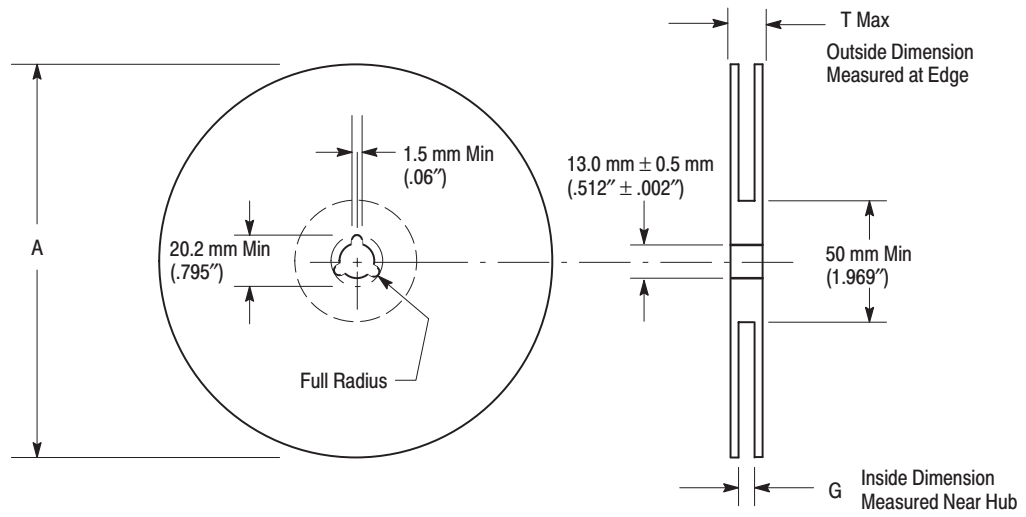

Size	A Max	G	T Max
8 mm	330 mm (12.992")	8.4 mm + 1.5 mm, -0.0 (.33" + .059", -0.00)	14.4 mm (.56")
12 mm	330 mm (12.992")	12.4 mm + 2.0 mm, -0.0 (.49" + .079", -0.00)	18.4 mm (.72")
16 mm	360 mm (14.173")	16.4 mm + 2.0 mm, -0.0 (.646" + .078", -0.00)	22.4 mm (.882")
24 mm	360 mm (14.173")	24.4 mm + 2.0 mm, -0.0 (.961" + .070", -0.00)	30.4 mm (1.197")

### Reel Dimensions

Metric Dimensions Govern — English are in parentheses for reference only

## LEAD TAPE PACKAGING STANDARDS FOR AXIAL-LEAD COMPONENTS

Case Type	Product Category	Device Title Suffix	MPQ Quantity Per Reel (Item 3.3.7)	Component Spacing A Dimension	Tape Spacing B Dimension	Reel Dimension C	Reel Dimension D (Max)	Max Off Alignment E
Case 17-02	Surmetic 40 & 600 Watt TVS	RL	4000	0.2 +/- 0.015	2.062 +/- 0.059	3	14	0.047
Case 41A-02	1500 Watt TVS	RL4	1500	0.4 +/- 0.02	2.062 +/- 0.059	3	14	0.047
Case 51-02	DO-7 Glass (For Reference only)	RL	3000	0.2 +/- 0.02	2.062 +/- 0.059	3	14	0.047
Case 59-03	DO-41 Glass & DO-41 Surmetic 30	RL	6000	0.2 +/- 0.015	2.062 +/- 0.059	3	14	0.047
	Rectifier							
Case 59-04	500 Watt TVS	RL	5000	0.2 +/- 0.02	2.062 +/- 0.059	3	14	0.047
	Rectifier							
Case 194-04	110 Amp TVS (Automotive)	RL	800	0.4 +/- 0.02	1.875 +/- 0.059	3	14	0.047
	Rectifier							
Case 267-02	Rectifier	RL	1500	0.4 +/- 0.02	2.062 +/- 0.059	3	14	0.047
Case 299-02	DO-35 Glass	RL	5000	0.2 +/- 0.02	2.062 +/- 0.059	3	14	0.047

**Table 1. Packaging Details (all dimensions in inches)**

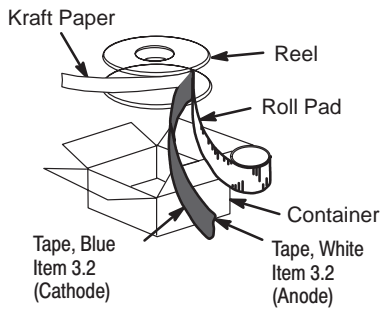

**Figure 1. Reel Packing**

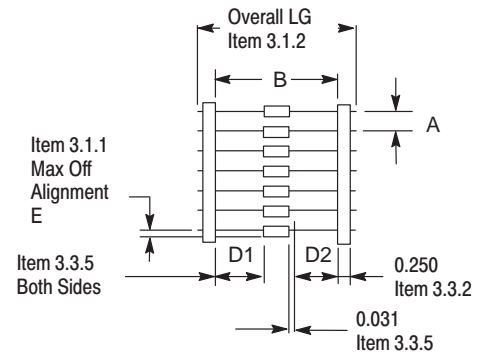

**Figure 2. Component Spacing**

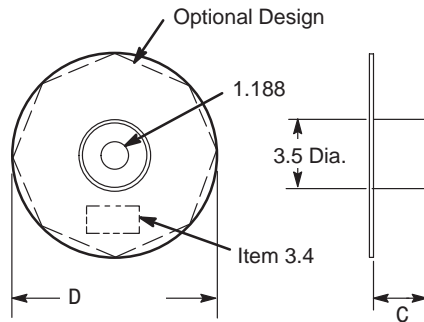

**Figure 3. Reel Dimensions**





## Index and Cross Reference

The following table represents an index and cross reference guide for all rectifier devices which are either manufactured directly by ON Semiconductor or for which ON Semiconductor manufactures a suitable equivalent. Where the ON Semiconductor part number differs from the industry part number, the ON Semiconductor device is a form, fit and function replacement for the industry type number – however, subtle differences in characteristics and/or specifications may exist. The part numbers listed in this Cross Reference are in computer sort.

Industry Part Number	ON Semiconductor Nearest Replacement	ON Semiconductor Similar Replacement	Page	Industry Part Number	ON Semiconductor Nearest Replacement	ON Semiconductor Similar Replacement	Page
10BF10	MURS110T3		286	182NQ030		MBRP20035L	280
10BF20	MURS120T3		286	182NQ030R		MBRP20035L	280
10BF40	MURS140T3		286	1N2069,A	1N4003		447
10BF60	MURS160T3		286	1N2070,A	1N4004		447
10BF80		MURS160T3	286	1N2071,A	1N4005		447
10BQ015		MBRS120T3	64	1N3611		1N4003	447
10BQ030	MBRS130T3		70	1N3611GP		1N4003	447
10BQ040	MBRS140T3		73	1N3612		1N4004	447
10BQ060		MBRS1100T3	80	1N3612GP		1N4004	447
10BQ100	MBRS1100T3		80	1N3613		1N4005	447
10CTF10		MUR840	370	1N3613GP		1N4005	447
10CTF20		MUR840	370	1N3614		1N4006	447
10CTF30		MUR840	370	1N3614GP		1N4006	447
10CTF40		MUR840	370	1N3957		1N4007	447
10DL1		1N4934	452	1N3957GP		1N4007	447
10DL2		1N4935	452	1N4001	1N4001		447
10MQ040N	MBRA140T3		61	1N4001GP		1N4001	447
10TQ030		MBR1035	207	1N4002	1N4002		447
10TQ035	MBR1035		207	1N4002GP		1N4002	447
10TQ040		MBR1045	207	1N4003	1N4003		447
10TQ045	MBR1045		207	1N4003GP		1N4003	447
11DQ03		1N5818	146	1N4004	1N4004		447
11DQ04		1N5819	146	1N4004GP		1N4004	447
11DQ05		MBR150	152	1N4005	1N4005		447
11DQ06		MBR160	152	1N4005GP		1N4005	447
11DQ09		MBR1100	156	1N4006	1N4006		447
11DQ10		MBR1100	156	1N4006GP		1N4006	447
12CTQ030		MBR1535CT	174	1N4007	1N4007		447
12CTQ035		MBR1535CT	174	1N4007GP		1N4007	447
12CTQ035S		MBRB1545CT	116	1N4245		1N4003	447
12CTQ040		MBR1545CT	174	1N4245GP		1N4003	447
12CTQ040S		MBRB1545CT	116	1N4246		1N4004	447
12CTQ045		MBR1545CT	174	1N4246GP		1N4004	447
12CTQ045S		MBRB1545CT	116	1N4247		1N4005	447
12CWQ03FN		MBRD1035CTL	108	1N4247GP		1N4005	447
12TQ035		MBR1635	215	1N4248		1N4006	447
12TQ035S		MBRB1545CT	116	1N4248GP		1N4006	447
12TQ040		MBR1645	215	1N4249		1N4007	447
12TQ040S		MBRB1545CT	116	1N4249GP		1N4007	447
12TQ045		MBR1645	215	1N4383GP		1N4003RL	447
12TQ045S		MBRB1545CT	116	1N4384GP		1N4004RL	447
15CTQ035	MBR1535CT		174	1N4385GP		1N4005RL	447
15CTQ035S		MBRB1545CT	116	1N4585GP		1N4006RL	447
15CTQ040		MBR1545CT	174	1N4586GP		1N4007RL	447
15CTQ040S		MBRB1545CT	116	1N4934	1N4934		452
15CTQ045	MBR1545CT		174	1N4934GP		1N4934	452
15CTQ045S	MBRB1545CT		116	1N4935	1N4935		452
180NQ035		MBRP20035L	280	1N4935GP		1N4935	452
181NQ035		MBRP20035L	280	1N4936	1N4936		452

Industry Part Number	ON Semiconductor Nearest Replacement	ON Semiconductor Similar Replacement	Page
1N4936GP		1N4936	452
1N4937	1N4937		452
1N4937GP		1N4937	452
1N4942		1N4935	452
1N4942GP		1N4935	452
1N4943		1N4936	452
1N4944		1N4936	452
1N4944GP		1N4936	452
1N4945		1N4937	452
1N4946		1N4937	452
1N4946GP		1N4937	452
1N5185		MR852	454
1N5185GP		MR852	454
1N5186		MR852	454
1N5186GP		MR852	454
1N5187		MR852	454
1N5187GP		MR852	454
1N5188		MR856	454
1N5188GP		MR856	454
1N5189		MR856	454
1N5189GP		MR856	454
1N5190		MR856	454
1N5190GP		MR856	454
1N5391		1N4001RL	447
1N5391GP		1N4001RL	447
1N5391S		1N4001RL	447
1N5392		1N4002RL	447
1N5392GP		1N4002RL	447
1N5392S		1N4002RL	447
1N5393		1N4003RL	447
1N5393GP		1N4003RL	447
1N5393S		1N4003RL	447
1N5394		1N4004RL	447
1N5394GP		1N4004RL	447
1N5395		1N4004RL	447
1N5395GP		1N4004RL	447
1N5395S		1N4004RL	447
1N5396		1N4005RL	447
1N5396GP		1N4005RL	447
1N5397		1N4005RL	447
1N5397GP		1N4005RL	447
1N5397S		1N4005RL	447
1N5398		1N4006RL	447
1N5398GP		1N4006RL	447
1N5398S		1N4006RL	447
1N5399		1N4007RL	447
1N5399GP		1N4007RL	447
1N5399S		1N4007RL	447
1N5401	1N5401		449
1N5402	1N5402		449
1N5403		1N5404	449
1N5404	1N5404		449
1N5405		1N5406	449
1N5406	1N5406		449
1N5415		MR852	454
1N5416		MR852	454

Industry Part Number	ON Semiconductor Nearest Replacement	ON Semiconductor Similar Replacement	Page
1N5417		MR852	454
1N5418		MR856	454
1N5419		MR856	454
1N5420		MR856	454
1N5614		1N4003	447
1N5615		1N4935	452
1N5615GP		1N4935	452
1N5616		1N4004	447
1N5617		1N4936	452
1N5617GP		1N4936	452
1N5618		1N4005	447
1N5619		1N4937	452
1N5619GP		1N4937	452
1N5620		1N4006	447
1N5802		MUR420	350
1N5803		MUR420	350
1N5804		MUR420	350
1N5805		MUR420	350
1N5806		MUR420	350
1N5807		MUR420	350
1N5808		MUR420	350
1N5809		MUR420	350
1N5810		MUR420	350
1N5811		MUR420	350
1N5817	1N5817		146
1N5818	1N5818		146
1N5819	1N5819		146
1N5820	1N5820		159
1N5821	1N5821		159
1N5822	1N5822		159
200CNQ020		MBRP20030CTL	252
200CNQ030	MBRP20030CTL		252
200CNQ035		MBRP20030CTL	252
200CNQ040		MBRP20045CT	262
200CNQ045	MBRP20045CT		262
201CNQ020		MBRP20030CTL	252
201CNQ030	MBRP20030CTL		252
201CNQ035		MBRP20030CTL	252
201CNQ040		MBRP20045CT	262
201CNQ045	MBRP20045CT		262
208CMQ060	MBRP20060CT		270
208CNQ060	MBRP20060CT		270
20CTQ030	MBR2030CTL		180
20CTQ035		MBR2030CTL	180
20CTQ040		MBR2045CT	184
20CTQ045	MBR2045CT		184
21DQ03		1N5821	159
21DQ04		1N5822	159
220CNQ030	MBRP20030CTL		252
25CTQ035		MBR2535CTL	195
25CTQ035S		MBRB2535CTL	127
25CTQ040		MBR2545CT	198
25CTQ040S		MBRB2545CT	130
25CTQ045		MBR2545CT	198
25CTQ045S		MBRB2545CT	130
28CPQ030		MBR3045PT	232

Industry Part Number	ON Semiconductor Nearest Replacement	ON Semiconductor Similar Replacement	Page
28CPQ040		MBR3045PT	232
301CNQ040		MBRP30045CT	265
301CNQ045		MBRP30045CT	265
301CNQ050		MBRP30060CT	275
30BF20	MURS320T3		299
30BF40	MURS340T3		299
30BF60	MURS360T3		299
30BQ015		MBRS320T3	94
30BQ040	MBRS340T3		94
30BQ060	MBRS360T3		94
30CPQ035		MBR3045WT	241
30CPQ040		MBR3045WT	241
30CPQ045	MBR3045WT		241
30CPQ050		MBR3045WT	241
30CTQ030		MBR2545CT	198
30CTQ035	MBR2535CTL		195
30CTQ035S		MBRB2535CTL	127
30CTQ040		MBR2545CT	198
30CTQ040S		MBRB2545CT	130
30CTQ045	MBR2545CT		198
30CTQ045S		MBRB2545CT	130
30CTQ050		MBR2545CT	198
30CTQ050S		MBRB2545CT	130
30DL1	MR852		454
30DL2	MR852		454
30WQ03FN	MBRD330T4		97
30WQ04FN		MBRD350T4	97
30WQ06FN	MBRD360T4		97
31DQ03		1N5821	159
31DQ04		1N5822	159
31DQ05		MBR350	168
31DQ06		MBR360	168
31DQ09		MBR3100	171
31DQ10		MBR3100	171
32CTQ030		MBR2535CTL	195
32CTQ030S	MBRB3030CT		132
400CNQ040		MBRP40045CTL	268
400CNQ045		MBRP40045CTL	268
400DMQ045		MBRP40045CTL	268
401CMQ045		MBRP40045CTL	268
401CNQ040		MBRP40045CTL	268
401CNQ045		MBRP40045CTL	268
403CMQ100		MBRP400100CTL	278
403CNQ100		MBRP400100CTL	278
40CPQ035		MBR4045WT	248
40CPQ040		MBR4045WT	248
40CPQ045	MBR4045WT		248
40D1		MR754	484
40D2		MR754	484
40D4		MR754	484
40D6		MR760	484
40D8		MR760	484
40L15CQ	MBR4015LWT		244
40L40CW		MBR4045WT	248
40L45CW		MBR4045WT	248
42CTQ030S	MBRB4030		142

Industry Part Number	ON Semiconductor Nearest Replacement	ON Semiconductor Similar Replacement	Page
50WQ03FN		MBRD630CTT4	101
50WQ04FN		MBRD650CTT4	101
50WQ06FN		MBRD660CTT4	101
6A05		MR754	484
6A1		MR754	484
6A10		MR760	484
6A2		MR754	484
6A4		MR754	484
6A6		MR760	484
6A8		MR760	484
6CWQ03FN	MBRD630CTT4		101
6CWQ04FN		MBRD650CTT4	101
6CWQ06FN	MBRD660CTT4		101
6TQ035	MBR735		204
6TQ040		MBR745	204
6TQ045	MBR745		204
72CPQ030	MBR7030WT		NA
8TQ080		MBR1090	212
8TQ100		MBR10100	212
A114A		1N4934	452
A114B		1N4935	452
A114C		1N4936	452
A114D		1N4936	452
A114E		1N4937	452
A114F		1N4933	452
A114M		1N4937	452
A115A		MR852	454
A115B		MR852	454
A115C		MR856	454
A115D		MR856	454
A115E		MR856	454
A115F		MR852	454
A115M		MR856	454
A14A		1N4002	447
A14C		1N4004	447
A14D		1N4004	447
A14E		1N4005	447
A14F		1N4001	447
A14M		1N4005	447
A14N		1N4006	447
A14P		1N4007	447
AR25A		MR2504	463
AR25B		MR2504	463
AR25D		MR2504	463
AR25G		MR2504	463
AR25J		MR2510	463
AR25K		MR2510	463
AR25M		MR2510	463
ARS25A		MR2504	463
ARS25B		MR2504	463
ARS25D		MR2504	463
ARS25G		MR2504	463
ARS25J		MR2510	463
ARS25K		MR2510	463
ARS25M		MR2510	463
B0520LW	MBR0520LT1,T3		28

Industry Part Number	ON Semiconductor Nearest Replacement	ON Semiconductor Similar Replacement	Page
B0520W	MBR0520LT1,T3		28
B0530W	MBR0530T1,T3		31
B0540W	MBR0540T1,T3		34
B1100B	MBRS1100T3		80
B1100LB	MBRS1100T3		80
B120		MBRA130LT3	58
B120B	MBRS120T3		64
B130	MBRA130LT3		58
B130B	MBRS130LT3		67
B140	MBRA140T3		61
B140B	MBRS140LT3		76
B150		MBRA140T3	61
B150B		MBRS140T3	73
B160		MBRA140T3	61
B160B		MBRS1100T3	80
B170B		MBRS1100T3	80
B180B		MBRS1100T3	80
B190B		MBRS1100T3	80
B220A		MBRA130LT3	58
B230A		MBRA130LT3	58
B240		MBRS240LT3	87
B240A		MBRA130LT3	58
B250		MBRS240LT3	87
B250A		MBRA140T3	61
B260		MBRS1100T3	80
B260A		MBRA140T3	61
B320	MBRS320T3		94
B320A		MBRA130LT3	58
B330	MBRS330T3		94
B330A		MBRA130LT3	58
B340	MBRS340T3		94
B340A		MBRA140T3	61
B340B		MBRS240LT3	87
B350		MBRS360T3	94
B350A		MBRA140T3	61
B350B		MBRS240LT3	87
B360		MBRS360T3	94
B360A		MBRA140T3	61
B360B		MBRS1100T3	80
B520C		MBRS320T3	94
B530C		MBRS330T3	94
B540C		MBRS340T3	94
B550C		MBRS360T3	94
B560C		MBRS360T3	94
BA157	1N4936RL		452
BA158	1N4937RL		452
BY229-200	MUR820		370
BY229-400	MUR840		370
BY229-600	MUR860		370
BYP21-100		MUR820	370
BYP21-150		MUR820	370
BYP21-200		MUR820	370
BYP21-50		MUR820	370
BYP22-100		MUR3020PT	425
BYP22-150		MUR3020PT	425
BYP22-200		MUR3020PT	425

Industry Part Number	ON Semiconductor Nearest Replacement	ON Semiconductor Similar Replacement	Page
BYP22-50		MUR3020PT	425
BY251GP	1N5402RL		449
BY252GP	1N5404RL		449
BY253GP	1N5406RL		449
BY254GP	1N5407RL		449
BYQ28-100		MUR1620CT	402
BYQ28-150		MUR1620CT	402
BYQ28-200		MUR1620CT	402
BYQ28-50		MUR1620CT	402
BYR29-600	MUR860		370
BYS92-40		MBRP20045CT	262
BYS92-45		MBRP20045CT	262
BYS92-50		MBRP20060CT	270
BYS93-40		MBRP30045CT	265
BYS93-45		MBRP30045CT	265
BYS93-50		MBRP30060CT	275
BYS95-40		MBRP20045CT	262
BYS95-45		MBRP20045CT	262
BYS95-50		MBRP20060CT	270
BYS97-40		MBRP20045CT	262
BYS97-45		MBRP20045CT	262
BYS97-50		MBRP20060CT	270
BYS98-40		MBRP20045CT	262
BYS98-45		MBRP20045CT	262
BYS98-50		MBR1545CT	174
BYT08P-1000	MUR8100E		376
BYT08P-400	MUR840		370
BYT12P-1000		MUR10120E	387
BYT28-300		MUR1660CT	402
BYT28-400		MUR1660CT	402
BYT28-500		MUR1660CT	402
BYT6P-400	MUR1640CT		402
BYT79-300		MUR1560	393
BYT79-400		MUR1560	393
BYT79-500		MUR1560	393
BYV18-35		MBR1545CT	174
BYV18-45		MBR1545CT	174
BYV19-35	MBR1045		207
BYV19-45	MBR1045		207
BYV26A		MUR120	324
BYV26B		MUR140	324
BYV26C		MUR160	324
BYV27-100		MUR120	324
BYV27-150		MUR120	324
BYV27-50		MUR120	324
BYV28-100		MUR420	350
BYV28-150		MUR420	350
BYV28-50		MBR2045CT	184
BYV29-300		MUR1560	393
BYV29-400		MUR1560	393
BYV29-500		MUR1560	393
BYV32-100		MUR1620CT	402
BYV32-150		MUR1620CT	402
BYV32-200		MUR1620CT	402
BYV32-50		MUR1620CT	402
BYV33-35	MBR2045CT		184

Industry Part Number	ON Semiconductor Nearest Replacement	ON Semiconductor Similar Replacement	Page
BYV33-40	MBR2045CT		184
BYV33-45	MBR2045CT		184
BYV39-35	MBR1645		215
BYV39-40	MBR1645		215
BYV39-45	MBR1645		215
BYV43-35		MBR2545CT	198
BYV43-40		MBR2545CT	198
BYV43-45		MBR2545CT	198
BYVB32-100		MURB1620CT	313
BYVB32-150		MURB1620CT	313
BYVB32-200		MURB1620CT	313
BYVB32-50		MURB1620CT	313
BYW29-100	MUR820		370
BYW29-150	MUR820		370
BYW29-200	MUR820		370
BYW29-50	MUR820		370
BYW4200B		MURD620CT	306
BYW51-200		MUR1620CT	402
BYW51F-200		MURF1620CT	411
BYW80-100	MUR820		370
BYW80-150	MUR820		370
BYW80-200	MUR820		370
BYW80-50	MUR820		370
BYW81P-200		MUR1520	393
BYW98-200		MUR420	350
BYW99W-200		MUR3020WT	431
CPT12035	MBRP20045CT		262
CPT12045	MBRP20045CT		262
CPT12050	MBRP20060CT		270
CPT20035	MBRP20045CT		262
CPT20045	MBRP20045CT		262
CPT20050	MBRP20060CT		270
CPT20120	MBRP20030CTL		252
CPT20125	MBRP20030CTL		252
CPT30035	MBRP30045CT		265
CPT30045	MBRP30045CT		265
CPT30050	MBRP30060CT		275
EGP10A	MUR120		324
EGP10B	MUR120		324
EGP10C	MUR120		324
EGP10D	MUR120		324
EGP10F		MUR160	324
EGP10G		MUR160	324
EGP10J		MUR160	324
EGP10K		MUR180E	329
EGP20A		MUR420	350
EGP20B		MUR420	350
EGP20C		MUR420	350
EGP20D		MUR420	350
EGP20F		MUR460	350
EGP20G		MUR460	350
EGP20J		MUR460	350
EGP20K		MUR480E	355
EGP30A	MUR420		350
EGP30B	MUR420		350
EGP30C	MUR420		350

Industry Part Number	ON Semiconductor Nearest Replacement	ON Semiconductor Similar Replacement	Page
EGP30D	MUR420		350
EGP30F		MUR460	350
EGP30G		MUR460	350
EGP30J		MUR460	350
EGP30K		MUR480E	355
EGP50A	MUR420		350
EGP50B	MUR420		350
EGP50C	MUR420		350
EGP50D	MUR420		350
ERA81		1N5819	146
ERB35	MUR120		324
ERB44	1N4935		452
ERB91	MUR120		324
ERC24	1N4936		452
ERC38	MUR140		324
ERC62	MBR1045		207
ERC80	MBR745		204
ERC90	MUR820		370
ERC91	MUR420		350
ES1A		MRA4003T3	456
ES1B		MRA4003T3	456
ES1C		MRA4003T3	456
ES1D	MRA4003T3		456
ES1G	MRA4004T3		456
ES2A		MURS105T3	286
ES2AA		MRA4003T3	456
ES2B		MURS110T3	286
ES2BA		MRA4003T3	456
ES2C		MURS115T3	286
ES2CA		MRA4003T3	456
ES2D	MURS120T3		286
ES2DA	MRA4003T3		456
ES2F		MURS140T3	286
ES2G		MURS140T3	286
ES3A		MURS320T3	299
ES3AB		MURS105T3	286
ES3B		MURS320T3	299
ES3BB		MURS110T3	286
ES3C		MURS320T3	299
ES3CB		MURS115T3	286
ES3D	MURS320T3		299
ES3DB	MURS120T3		286
ES3F		MURS340T3	299
ES3G	MURS340T3		299
ESAB33	MUR820		370
ESAB82	MBR745		204
ESAB92	MUR820		370
ESAC33	MUR820		370
ESAC82	MBR1045		207
ESAC92	MUR1520		393
ESAC93		MUR3020PT	425
ESAD33		MUR3040PT	425
FE16A		MUR1620CT	402
FE16B		MUR1620CT	402
FE16C		MUR1620CT	402
FE16D		MUR1620CT	402

Industry Part Number	ON Semiconductor Nearest Replacement	ON Semiconductor Similar Replacement	Page
FE16F		MUR1660CT	402
FE16G		MUR1660CT	402
FE1A		MUR120	324
FE1B		MUR120	324
FE1C		MUR120	324
FE1D		MUR120	324
FE2A		MUR420	350
FE2B		MUR420	350
FE2C		MUR420	350
FE2D		MUR420	350
FE3A		MUR420	350
FE3B		MUR420	350
FE3C		MUR420	350
FE3D		MUR420	350
FE5A		MUR420	350
FE5B		MUR420	350
FE5C		MUR420	350
FE5D		MUR420	350
FE6A		MUR420	350
FE6B		MUR420	350
FE6C		MUR420	350
FE6D		MUR420	350
FE8A		MUR420	350
FE8B		MUR820	370
FE8C		MUR820	370
FE8D		MUR820	370
FE8F		MUR840	370
FE8G		MUR840	370
FEP16AT		MUR1620CT	402
FEP16BT		MUR1620CT	402
FEP16CT		MUR1620CT	402
FEP16DT		MUR1620CT	402
FEP16FT		MUR1640CT	402
FEP16GT		MUR1640CT	402
FEP16HT		MUR1660CT	402
FEP16JT		MUR1660CT	402
FEP30AP		MUR3020WT	431
FEP30BP		MUR3020WT	431
FEP30CP		MUR3020WT	431
FEP30DP		MUR3020WT	431
FEP30FP		MUR3060WT	431
FEP30GP		MUR3060WT	431
FEP30HP		MUR3060WT	431
FEP30JP		MUR3060WT	431
FEP6AT		MUR620CT	363
FEP6BT		MUR620CT	363
FEP6CT		MUR620CT	363
FEP6DT		MUR620CT	363
FEPB16AT		MURB1620CT	313
FEPB16BT		MURB1620CT	313
FEPB16CT		MURB1620CT	313
FEPB16DT		MURB1620CT	313
FES16AT		MUR1520	393
FES16BT		MUR1520	393
FES16CT		MUR1520	393
FES16DT		MUR1520	393

Industry Part Number	ON Semiconductor Nearest Replacement	ON Semiconductor Similar Replacement	Page
FES16FT		MUR1540	393
FES16GT		MUR1540	393
FES16HT		MUR1560	393
FES16JT		MUR1560	393
FES8AT		MUR820	370
FES8BT		MUR820	370
FES8CT		MUR820	370
FES8DT		MUR820	370
FES8FT		MUR840	370
FES8GT		MUR840	370
FES8HT		MUR860	370
FES8JT		MUR860	370
FESB16AT		MURB1620CT	313
FESB16BT		MURB1620CT	313
FESB16CT		MURB1620CT	313
FESB16DT		MURB1620CT	313
FM120		MBRA130LT3	58
FM130		MBRA130LT3	58
FM140		MBRA140T3	61
FM5817		MBRA130LT3	58
FM5818		MBRA130LT3	58
FM5819		MBRA140T3	61
FR061		1N4933	452
FR061L	1N4933		452
FR062		1N4934	452
FR062L	1N4934		452
FR063		1N4935	452
FR063L	1N4935		452
FR064		1N4936	452
FR065		1N4937	452
FR065L	1N4936		452
FR065L	1N4937		452
FR101	1N4933		452
FR102	1N4934		452
FR103	1N4935		452
FR104	1N4936		452
FR105	1N4937		452
FR251		MR852	454
FR252		MR852	454
FR253		MR852	454
FR254		MR856	454
FR255		MR856	454
FR301	MR852		454
FR302	MR852		454
FR303	MR852		454
FR304	MR856		454
FR305	MR856		454
FRM3205CC	MUR3020PT		425
FRM3210CC	MUR3020PT		425
FRM3215CC	MUR3020PT		425
FRM3220CC	MUR3020PT		425
FRP1605CC	MUR1620CT		402
FRP1610CC	MUR1620CT		402
FRP1615CC	MUR1620CT		402
FRP1620CC	MUR1620CT		402
FRP805	MUR820		370

Industry Part Number	ON Semiconductor Nearest Replacement	ON Semiconductor Similar Replacement	Page
FRP810	MUR820		370
FRP815	MUR820		370
FRP820	MUR820		370
FST1240	MBR1545CT		174
FST1245	MBR1545CT		174
FST1540	MBR1545CT		174
FST1545	MBR1545CT		174
FST20035		MBRP20045CT	262
FST20040		MBRP20045CT	262
FST20045		MBRP20045CT	262
FST20050		MBRP20060CT	270
FST2040	MBR2045CT		184
FST2045	MBR2045CT		184
FST2050	MBR2060CT		189
FST30035		MBRP30045CT	265
FST30040		MBRP30045CT	265
FST30045		MBRP30045CT	265
FST30050		MBRP30060CT	275
FST3040	MBR2545CT		198
FST3045	MBR2545CT		198
FST6035		MBRP20045CT	262
FST6040		MBRP20045CT	262
FST6045		MBRP20045CT	262
FST6050		MBRP20060CT	270
GER4001		1N4001	447
GER4002		1N4002	447
GER4003		1N4003	447
GER4004		1N4004	447
GER4005		1N4005	447
GER4006		1N4006	447
GER4007		1N4007	447
GI1001		MUR120	324
GI1002		MUR120	324
GI1003		MUR120	324
GI1004		MUR120	324
GI1101		MUR420	350
GI1102		MUR420	350
GI1103		MUR420	350
GI1104		MUR420	350
GI1301		MUR420	350
GI1302		MUR420	350
GI1303		MUR420	350
GI1304		MUR420	350
GI1401	MUR820		370
GI1402	MUR820		370
GI1403	MUR820		370
GI1404	MUR820		370
GI2401	MUR1620CT		402
GI2402	MUR1620CT		402
GI2403	MUR1620CT		402
GI2404	MUR1620CT		402
GI2500	MR2504		463
GI2501	MR2504		463
GI2502	MR2504		463
GI2504	MR2504		463
GI2506	MR2510		463

Industry Part Number	ON Semiconductor Nearest Replacement	ON Semiconductor Similar Replacement	Page
GI2508	MR2510		463
GI2510	MR2510		463
GI500	1N5400RL		449
GI501	1N5401RL		449
GI502	1N5402RL		449
GI504	1N5404RL		449
GI506	1N5406RL		449
GI508	1N5407RL		449
GI510	1N5408RL		449
GI750		MR754	484
GI751		MR754	484
GI752		MR754	484
GI754		MR754	484
GI756		MR760	484
GI758		MR760	484
GI810		1N4933RL	452
GI811		1N4934RL	452
GI812		1N4935RL	452
GI814		1N4936RL	452
GI816		1N4937RL	452
GI850	MR852		454
GI851	MR852		454
GI852	MR852		454
GI854	MR856		454
GI856	MR856		454
GIB2401		MURB1620CT	313
GIB2402		MURB1620CT	313
GIB2403		MURB1620CT	313
GIB2404		MURB1620CT	313
GP08A		1N4001RL	447
GP08B		1N4002RL	447
GP08D		1N4003RL	447
GP08G		1N4004RL	447
GP08J		1N4005RL	447
GP10A		1N4001	447
GP10B		1N4002	447
GP10D		1N4003	447
GP10G		1N4004	447
GP10J		1N4005	447
GP10K		1N4006	447
GP10M		1N4007	447
GP15A		1N4001RL	447
GP15B		1N4002RL	447
GP15D		1N4003RL	447
GP15G		1N4004RL	447
GP15J		1N4005RL	447
GP15K		1N4006RL	447
GP15M		1N4007RL	447
GP30A	1N5400RL		449
GP30B	1N5401RL		449
GP30D	1N5402RL		449
GP30G	1N5404RL		449
GP30J	1N5406RL		449
GP30K	1N5407RL		449
GP30M	1N5408RL		449
GP80A	MUR820		370



Industry Part Number	ON Semiconductor Nearest Replacement	ON Semiconductor Similar Replacement	Page
GP80B	MUR820		370
GP80D	MUR820		370
GP80G	MUR840		370
GP80J	MUR860		370
HER101	MUR120		324
HER102	MUR120		324
HER103	MUR120		324
HER104	MUR140		324
HER105	MUR140		324
HER151		MUR120	324
HER152		MUR120	324
HER153		MUR120	324
HER154		MUR140	324
HER155		MUR140	324
HER301	MUR420		350
HER302	MUR420		350
HER303	MUR420		350
HER801	MUR820		370
HER802	MUR820		370
HER803	MUR820		370
HER804	MUR840		370
HER805	MUR840		370
HFA15TB60		MUR1560	393
HFA16TA60C		MUR1660CT	402
HFA200MD40C		MURP20040CT	436
HFA200MD40D		MURP20040CT	436
HFA30PA60C		MUR3060WT	431
LT2A01		1N5400RL	449
LT2A02		1N5401RL	449
LT2A03		1N5402RL	449
LT2A04		1N5404RL	449
LT2A05		1N5406RL	449
LT2A06		1N5407RL	449
LT2A07		1N5408RL	449
M100A	1N4001RL		447
M100B	1N4002RL		447
M100D	1N4003RL		447
M100G	1N4004RL		447
M100J	1N4005RL		447
M100K	1N4006RL		447
M100M	1N4007RL		447
MBR0520L	MBR0520LT1,T3		28
MBR0540	MBR0540T1,T3		34
MBR10100	MBR10100		212
MBR1030		MBR1035	207
MBR1030CT		MBR1535CT	174
MBR1035	MBR1035		207
MBR1035CT		MBR1535CT	174
MBR1040		MBR1045	207
MBR1040CT		MBR1545CT	174
MBR1045	MBR1045		207
MBR1045CT		MBR1545CT	174
MBR1050		MBR1060	212
MBR1050		MBR1060	212
MBR1050		MBR1060	212
MBR1060	MBR1060		212

Industry Part Number	ON Semiconductor Nearest Replacement	ON Semiconductor Similar Replacement	Page
MBR1070	MBR1100		156
MBR1080	MBR1100		156
MBR1090	MBR1100		156
MBR1100	MBR1100		156
MBR12035CT	MBRP20045CT		262
MBR12045CT	MBRP20045CT		262
MBR12050CT	MBRP20060CT		270
MBR12060CT	MBRP20060CT		270
MBR150	MBR160		152
MBR1535CT	MBR1535CT		174
MBR1540CT		MBR1545CT	174
MBR1545CT	MBR1545CT		174
MBR1550CT		MBR1545CT	174
MBR1560CT		MBR2060CT	189
MBR160	MBR160		152
MBR1630		MBR1635	215
MBR1635	MBR1635		215
MBR1640		MBR1645	215
MBR1645	MBR1645		215
MBR1650		MBR1645	215
MBR170	MBR1100		156
MBR180	MBR1100		156
MBR190	MBR1100		156
MBR20015CTL	MBRP20030CTL		252
MBR20020CTL	MBRP20030CTL		252
MBR20025CTL	MBRP20030CTL		252
MBR20030CTL	MBRP20030CTL		252
MBR20035CT	MBRP20045CT		262
MBR20045CT	MBRP20045CT		262
MBR20050CT	MBRP20060CT		270
MBR20060CT	MBRP20060CT		270
MBR20100CT	MBR20100CT		189
MBR2015CTL	MBR2030CTL		180
MBR20200CT	MBR20200CT		192
MBR2030CTL	MBR2030CTL		180
MBR2035CT	MBR2045CT		184
MBR2040CT		MBR2045CT	184
MBR2045CT	MBR2045CT		184
MBR2050CT		MBR2060CT	189
MBR2060CT	MBR2060CT		189
MBR2070CT	MBR2080CT		189
MBR2080CT	MBR2080CT		189
MBR2090CT	MBR2090CT		189
MBR2535CT	MBR2545CT		198
MBR2535CTL	MBR2535CTL		195
MBR2545CT	MBR2545CT		198
MBR2550CT		MBR2545CT	198
MBR30035CT	MBRP30045CT		265
MBR30045CT	MBRP30045CT		265
MBR30050CT	MBRP30060CT		275
MBR30060CT	MBRP30060CT		275
MBR3035CT		MBR2535CTL	195
MBR3035PT	MBR3045PT		232
MBR3035WT	MBR3045WT		241
MBR3040PT		MBR3045PT	232
MBR3045CT		MBR2545CT	198



Industry Part Number	ON Semiconductor Nearest Replacement	ON Semiconductor Similar Replacement	Page
MBR3045PT	MBR3045PT		232
MBR3045WT	MBR3045WT		241
MBR3050PT		MBR3045PT	232
MBR3100	MBR3100		171
MBR320	MBR340		165
MBR330	MBR340		165
MBR340	MBR340		165
MBR350	MBR360		168
MBR360	MBR360		168
MBR370	MBR3100		171
MBR380	MBR3100		171
MBR390	MBR3100		171
MBR4030PT		MBR4045PT	235
MBR4035PT		MBR4045PT	235
MBR4045PT	MBR4045PT		235
MBR4045WT	MBR4045WT		248
MBR4050PT		MBR4045PT	235
MBR5025L	MBR5025L		239
MBR60035CTL	MBRP60035CTL		259
MBR6030PT		MBR6045PT	237
MBR6035PT		MBR6045PT	237
MBR6040PT		MBR6045PT	237
MBR6045PT	MBR6045PT		237
MBR6045WT	MBR6045WT		250
MBR730		MBR735	204
MBR735	MBR735		204
MBR740		MBR745	204
MBR745	MBR745		204
MBR750		MBR745	204
MBRA130LT3	MBRA130LT3		58
MBRA140T3	MBRA140T3		61
MBRB1035		MBRB1545CT	116
MBRB1045		MBRB1545CT	116
MBRB1050		MBRB1545CT	116
MBRB1530CT		MBRB1545CT	116
MBRB1535CT		MBRB1545CT	116
MBRB1540CT		MBRB1545CT	116
MBRB1545CT	MBRB1545CT		116
MBRB1550CT		MBRB1545CT	116
MBRB1635		MBRB1545CT	116
MBRB1645		MBRB1545CT	116
MBRB1650		MBRB1545CT	116
MBRB20100CT	MBRB20100CT		120
MBRB2035CT		MBRB2535CTL	127
MBRB2045CT		MBRB2545CT	130
MBRB2050CT		MBRB2545CT	130
MBRB2060CT	MBRB2060CT		118
MBRB2080CT		MBRB20100CT	120
MBRB2090CT		MBRB20100CT	120
MBRB2515L	MBRB2515L		125
MBRB2535CTL	MBRB2535CTL		127
MBRB2545CT	MBRB2545CT		130
MBRB3035CT		MBRB3030CT	132
MBRB3045CT		MBRB2545CT	130
MBRD320	MBRD340		97
MBRD330	MBRD340		97

Industry Part Number	ON Semiconductor Nearest Replacement	ON Semiconductor Similar Replacement	Page
MBRD340	MBRD340		97
MBRD350	MBRD360		97
MBRD360	MBRD360		97
MBRD620CT	MBRD640CT		101
MBRD630CT	MBRD640CT		101
MBRD640CT	MBRD640CT		101
MBRD650CT	MBRD660CT		101
MBRD660CT	MBRD660CT		101
MBRF20100CT	MBRF20100CT		223
MBRF2035CT		MBRF2545CT	229
MBRF2045CT		MBRF2545CT	229
MBRF2050CT		MBRF2545CT	229
MBRF2060CT		MBRF20100CT	223
MBRF2090CT		MBRF20100CT	223
MBRF2535CT	MBRF2545CT		229
MBRF2545CT	MBRF2545CT		229
MBRF2550CT		MBRF2545CT	229
MBRM120LT3	MBRM120LT3		43
MBRM130LT3	MBRM130LT3		48
MBRM140T3	MBRM140T3		53
MBRS1100T3	MBRS1100T3		80
MBRS130LT3	MBRS130LT3		67
MBRS140T3	MBRS140T3		73
MBRS320	MBRS320T3		94
MBRS340	MBRS340T3		94
MBRS340T3	MBRS340T3		94
MR2500	MR2504		463
MR2501	MR2504		463
MR2502	MR2504		463
MR2504	MR2504		463
MR2506	MR2510		463
MR2508	MR2510		463
MR2510	MR2510		463
MR2535L	MR2535L		501
MR750	MR754		484
MR751	MR754		484
MR752	MR754		484
MR754	MR754		484
MR756	MR760		484
MR758	MR760		484
MR760	MR760		484
MR850	MR852		454
MR851	MR852		454
MR852	MR852		454
MR854	MR856		454
MR856	MR856		454
MUR10005CT	MURP20020CT		436
MUR10010CT	MURP20020CT		436
MUR10015CT	MURP20020CT		436
MUR10020CT	MURP20020CT		436
MUR10120E	MUR10120E		387
MUR10150E	MUR10150E		390
MUR105	MUR120		324
MUR110	MUR120		324
MUR1100E	MUR1100E		329
MUR115	MUR120		324

Industry Part Number	ON Semiconductor Nearest Replacement	ON Semiconductor Similar Replacement	Page
MUR120	MUR120		324
MUR130	MUR140		324
MUR140	MUR160		324
MUR150	MUR160		324
MUR1505	MUR1520		393
MUR1510	MUR1520		393
MUR1515	MUR1520		393
MUR1520	MUR1520		393
MUR1530	MUR1540		393
MUR1540	MUR1540		393
MUR1550	MUR1560		393
MUR1560	MUR1560		393
MUR160	MUR160		324
MUR1605CT	MUR1620CT		402
MUR1605CTR	MUR1620CTR		408
MUR1610CT	MUR1620CT		402
MUR1610CTR	MUR1620CTR		408
MUR1615CT	MUR1620CT		402
MUR1615CTR	MUR1620CTR		408
MUR1620CT	MUR1620CT		402
MUR1620CTR	MUR1620CTR		408
MUR1630CT	MUR1640CT		402
MUR1640CT	MUR1640CT		402
MUR1650CT	MUR1660CT		402
MUR1660CT	MUR1660CT		402
MUR170E	MUR1100E		329
MUR180E	MUR1100E		329
MUR190E	MUR1100E		329
MUR20005CT	MURP20020CT		436
MUR20010CT	MURP20020CT		436
MUR20015CT	MURP20020CT		436
MUR20020CT	MURP20020CT		436
MUR20030CT	MURP20040CT		436
MUR20040CT	MURP20040CT		436
MUR3005PT	MUR3020PT		425
MUR3010PT	MUR3020PT		425
MUR3015PT	MUR3020PT		425
MUR3020PT	MUR3020PT		425
MUR3020WT	MUR3020WT		431
MUR3030PT	MUR3040PT		425
MUR3040	MUR3040		419
MUR3040PT	MUR3040PT		425
MUR3050PT	MUR3060PT		425
MUR3060PT	MUR3060PT		425
MUR3060WT	MUR3060WT		431
MUR405	MUR420		350
MUR410	MUR420		350
MUR4100E	MUR4100E		355
MUR415	MUR420		350
MUR420	MUR420		350
MUR440	MUR460		350
MUR450	MUR460		350
MUR460	MUR460		350
MUR470E	MUR4100E		355
MUR480E	MUR4100E		355
MUR490E	MUR4100E		355

Industry Part Number	ON Semiconductor Nearest Replacement	ON Semiconductor Similar Replacement	Page
MUR5150E	MUR5150E		360
MUR6020	MUR6040		423
MUR6030	MUR6040		423
MUR6040	MUR6040		423
MUR605CT	MUR620CT		363
MUR610CT	MUR620CT		363
MUR615CT	MUR620CT		363
MUR620CT	MUR620CT		363
MUR805	MUR820		370
MUR810	MUR820		370
MUR8100E	MUR8100E		376
MUR815	MUR820		370
MUR820	MUR820		370
MUR830	MUR840		370
MUR840	MUR840		370
MUR850	MUR860		370
MUR860	MUR860		370
MUR870E	MUR8100E		376
MUR880E	MUR8100E		376
MUR890E	MUR8100E		376
MURB1610CT		MURB1620CT	313
MURB1620CT	MURB1620CT		313
MURD305	MURD320		303
MURD310	MURD320		303
MURD315	MURD320		303
MURD320	MURD320		303
MURD605CT	MURD620CT		306
MURD610CT	MURD620CT		306
MURD615CT	MURD620CT		306
MURD620CT	MURD620CT		306
MURH840CT	MURH840CT		381
MURH860CT	MURH860CT		384
MURHB840CT	MURHB840CT		319
MURS120T3	MURS120T3		286
MURS140	MURS140T3		286
MURS160	MURS160T3		286
MURS160T3	MURS160T3		286
MURS320T3	MURS320T3		299
MURS360T3	MURS360T3		299
P300A	1N5400RL		449
P300B	1N5401RL		449
P300D	1N5402RL		449
P300G	1N5404RL		449
P300J	1N5406RL		449
P300K	1N5407RL		449
P300M	1N5408RL		449
P600A		MR754	484
P600B		MR754	484
P600D		MR754	484
P600G		MR754	484
P600J		MR760	484
P600K		MR760	484
PR1001	1N4933RL		452
PR1002	1N4934RL		452
PR1003	1N4935RL		452
PR1004	1N4936RL		452

Industry Part Number	ON Semiconductor Nearest Replacement	ON Semiconductor Similar Replacement	Page
PR1005	1N4937RL		452
PR1501		1N4933RL	452
PR1501S	1N4933RL		452
PR1502		1N4934RL	452
PR1502S	1N4934RL		452
PR1503		1N4935RL	452
PR1503S	1N4935RL		452
PR1504		1N4936RL	452
PR1504S	1N4936RL		452
PR1505		1N4937RL	452
PR1505S	1N4937RL		452
PR2001		MR852	454
PR2002		MR852	454
PR2003		MR852	454
PR2004		MR854	454
PR2005		MR856	454
PR3001	MR852		454
PR3002	MR852		454
PR3003	MR852		454
PR3004	MR854		454
PR3005	MR856		454
R710XPT		MUR3020WT	431
R711X		MUR3020WT	431
R711XPT		MUR3020WT	431
R712X		MUR3020WT	431
R714XPT		MUR3020WT	431
RA2505	MR2504		463
RA251	MR2504		463
RA2510	MR2510		463
RA252	MR2504		463
RA253	MR2504		463
RA254	MR2504		463
RA255	MR2510		463
RA256	MR2510		463
RA258	MR2510		463
RB2D		MR852	454
RB2G		MR856	454
RG1A		1N4933	452
RG1B		1N4934	452
RG1D		1N4935	452
RG1G		1N4936	452
RG1J		1N4937	452
RG2A		MR852	454
RG2B		MR852	454
RG2J		MR856	454
RG3A		MR852	454
RG3B		MR852	454
RG3D		MR852	454
RG3G		MR856	454
RG3J		MR856	454
RG4A		MR852	454
RG4B		MR852	454
RG4D		MR852	454
RG4G		MR856	454
RG4J		MR856	454
RGM30A		MUR3020PT	425

Industry Part Number	ON Semiconductor Nearest Replacement	ON Semiconductor Similar Replacement	Page
RGM30B		MUR3020PT	425
RGM30D		MUR3020PT	425
RGM30G		MUR3040PT	425
RGP10A		1N4933	452
RGP10B		1N4934	452
RGP10D		1N4935	452
RGP10G		1N4936	452
RGP10J		1N4937	452
RGP15A		MR852	454
RGP15B		MR852	454
RGP15D		MR852	454
RGP15G		MR856	454
RGP15J		MR856	454
RGP20A		MR852	454
RGP20B		MR852	454
RGP20D		MR852	454
RGP20G		MR856	454
RGP20J		MR856	454
RGP25A		MR852	454
RGP25B		MR852	454
RGP25D		MR852	454
RGP25G		MR856	454
RGP25J		MR856	454
RGP30A		MR852	454
RGP30B		MR852	454
RGP30D		MR852	454
RGP30G		MR856	454
RGP30J		MR856	454
RGP80A	MUR820		370
RGP80B	MUR820		370
RGP80D	MUR820		370
RGP80G	MUR840		370
RGP80J	MUR860		370
RL061	1N4001		447
RL062	1N4002		447
RL063	1N4003		447
RL064	1N4004		447
RL065	1N4005		447
RL066	1N4006		447
RL067	1N4007		447
RL251		1N5400	449
RL252		1N5401	449
RL253		1N5402	449
RL254		1N5404	449
RL255		1N5406	449
RL256		1N5406	449
RL257		1N5406	449
RP300A	MR852		454
RP300B	MR852		454
RP300D	MR852		454
RP300G	MR856		454
RP300J	MR856		454
RS1A		MRA4003T3	456
RS1AB		MURS120T3	286
RS1B		MRA4003T3	456
RS1BB		MURS120T3	286

Industry Part Number	ON Semiconductor Nearest Replacement	ON Semiconductor Similar Replacement	Page
RS1D	MRA4003T3		456
RS1DB	MURS120T3		286
RS1G	MRA4004T3		456
RS1GB		MURS160T3	286
RS1J	MRA4005T3		456
RS1JB	MURS160T3		286
RS1K	MRA4006T3		456
RS1M	MRA4007T3		456
RS2A		MURS120T3	286
RS2B		MURS120T3	286
RS2BA		MRA4003T3	456
RS2D		MURS120T3	286
RS2DA	MRA4003T3		456
RS2G		MURS160T3	286
RS2GA	MRA4004T3		456
RS2J		MURS160T3	286
RS2JA	MRA4005T3		456
RS2KA	MRA4006T3		456
RS2MA	MRA4007T3		456
RS3A		MURS320T3	299
RS3AB		MURS120T3	286
RS3B		MURS320T3	299
RS3BB		MURS120T3	286
RS3D	MURS320T3		299
RS3DB	MURS120T3		286
RS3G		MURS360T3	299
RS3GB		MURS160T3	286
RS3J	MURS360T3		299
RS3JB	MURS160T3		286
RUD810	MUR1620CT		402
RUD815	MUR1620CT		402
RUD820	MUR1620CT		402
RUR810	MUR820		370
RUR815	MUR820		370
RUR820	MUR820		370
RURD1610		MUR3020PT	425
RURD1615		MUR3020PT	425
RURD1620		MUR3020PT	425
S1A		MRA4003T3	456
S1AB		MRS1504T3	459
S1B		MRA4003T3	456
S1BB		MRS1504T3	459
S1D	MRA4003T3		456
S1DB		MRS1504T3	459
S1G	MRA4004T3		456
S1GB		MRS1504T3	459
S1J	MRA4005T3		456
S1JB	MURS160T3		286
S1K	MRA4006T3		456
S1M	MRA4007T3		456
S210		MBRS1100T3	80
S2A		MRS1504T3	459
S2AA		MRA4003T3	456
S2B		MRS1504T3	459
S2BA		MRA4003T3	456
S2D		MRS1504T3	459

Industry Part Number	ON Semiconductor Nearest Replacement	ON Semiconductor Similar Replacement	Page
S2DA	MRA4003T3		456
S2G	MRS1504T3		459
S2GA	MRA4004T3		456
S2J		MURS160T3	286
S2JA	MRA4005T3		456
S2KA	MRA4006T3		456
S2MA	MRA4007T3		456
S3A		MURS320T3	299
S3AB		MURS120T3	286
S3B		MURS320T3	299
S3BB		MURS120T3	286
S3D	MURS320T3		299
S3DB	MURS120T3		286
S3G		MURS360T3	299
S3GB		MURS160T3	286
S3J	MURS360T3		299
S3JB	MURS160T3		286
S3K	MRA4006T3		456
S3M	MRA4007T3		456
S5AC		MURS320T3	299
S5BC		MURS320T3	299
S5CC	MURS320T3		299
S5GC		MURS360T3	299
S5JC	MURS360T3		299
SB1020	MBR1045		207
SB1035	MBR1045		207
SB1040	MBR1045		207
SB1045	MBR1045		207
SB1100	MBR1100		156
SB120		1N5817	146
SB130		1N5818	146
SB140		1N5819	146
SB150		MBR150	152
SB160		MBR160	152
SB1620		MBR1545CT	174
SB1630		MBR1545CT	174
SB1640		MBR1545CT	174
SB1645		MBR1545CT	174
SB170		MBR1100	156
SB180		MBR1100	156
SB190		MBR1100	156
SB3100		MBR3100	171
SB320		1N5820	159
SB330		1N5821	159
SB340		1N5822	159
SB350		MBR350RL	168
SB360		MBR360	168
SB370		MBR3100	171
SB380		MBR3100	171
SB390		MBR3100	171
SB5100		MBR3100	171
SBG1025L		MBRB1545CT	116
SBG1030CT		MBRB1545CT	116
SBG1035CT		MBRB1545CT	116
SBG1040CT		MBRB1545CT	116
SBG1045CT		MBRB1545CT	116

Industry Part Number	ON Semiconductor Nearest Replacement	ON Semiconductor Similar Replacement	Page
SBG1630CT		MBRB1545CT	116
SBG1635CT		MBRB1545CT	116
SBG1640CT		MBRB1545CT	116
SBG1645CT		MBRB1545CT	116
SBG3030CT		MBRB3030CT	132
SBG3040CT		MBRB2545CT	130
SBG3050CT		MBRB2545CT	130
SBL1030		MBR1035	207
SBL1030CT		MBR1535CT	174
SBL1035		MBR1035	207
SBL1035CT		MBR1535CT	174
SBL1040		MBR1045	207
SBL1040CT		MBR1545CT	174
SBL1045		MBR1045	207
SBL1045CT		MBR1545CT	174
SBL1050		MBR1060	212
SBL1050CT		MBR1545CT	174
SBL1060		MBR1060	212
SBL1630		MBR1635	215
SBL1630CT		MBR1535CT	174
SBL1635		MBR1635	215
SBL1635CT		MBR1535CT	174
SBL1640		MBR1645	215
SBL1640CT		MBR1545CT	174
SBL1645		MBR1645	215
SBL1645CT		MBR1545CT	174
SBL1650		MBR1645	215
SBL1650CT		MBR1545CT	174
SBL1660CT		MBR2060CT	189
SBL2030CT		MBR2030CTL	180
SBL2035CT		MBR2045CT	184
SBL2040CT		MBR2045CT	184
SBL2045CT		MBR2045CT	184
SBL2050CT		MBR2060CT	189
SBL2060CT		MBR2060CT	189
SBL25L20CT		MBR2535CTL	195
SBL25L25CT		MBR2535CTL	195
SBL25L30CT		MBR2535CTL	195
SBL3030CT		MBR2535CTL	195
SBL3030PT		MBR3045PT	232
SBL3035PT		MBR3045PT	232
SBL3040CT		MBR2545CT	198
SBL3040PT		MBR3045PT	232
SBL3045CT		MBR2545CT	198
SBL3045PT		MBR3045PT	232
SBL3050CT		MBR2545CT	198
SBL3050PT		MBR3045PT	232
SBL6030PT		MBR6045PT	237
SBL6040PT		MBR6045PT	237
SBL6050PT		MBR6045PT	237
SBL8100		MBR10100	212
SBL830		MBR1035	207
SBL835		MBR1035	207
SBL840		MBR1045	207
SBL845		MBR1045	207
SBL850		MBR1060	212

Industry Part Number	ON Semiconductor Nearest Replacement	ON Semiconductor Similar Replacement	Page
SBL860		MBR1060	212
SBL870		MBR1090	212
SBL880		MBR1090	212
SBL890		MBR1090	212
SBLB1030CT		MBRB1545CT	116
SBLB1040CT		MBRB1545CT	116
SBLB1630CT		MBRB1545CT	116
SBLB1640CT		MBRB1545CT	116
SBLB2030CT		MBRB2535CTL	127
SBLB2040CT		MBRB2535CTL	127
SBLB25L20CT		MBRB2535CTL	127
SBLB25L25CT		MBRB2535CTL	127
SBLB25L30CT		MBRB2535CTL	127
SBLF2030CT		MBRF2545CT	229
SBLF2040CT		MBRF2545CT	229
SBLF25L20CT		MBRF2545CT	229
SBLF25L25CT		MBRF2545CT	229
SBLF25L30CT		MBRF2545CT	229
SBP1020T	MBR1545CT		174
SBP1030T	MBR1545CT		174
SBP1035T	MBR1545CT		174
SBP1040T	MBR1545CT		174
SBP1045T	MBR1545CT		174
SBP1620T	MBR1545CT		174
SBP1630T	MBR1545CT		174
SBP1635T	MBR1545CT		174
SBP1640T	MBR1545CT		174
SBP1645T	MBR1545CT		174
SBR1040	MBR1045		207
SBR1045	MBR1045		207
SBR1050	MBR1060		212
SBR1640	MBR1645		215
SBR1645	MBR1645		215
SBS1020T	MBR1045		207
SBS1030T	MBR1045		207
SBS1035T	MBR1045		207
SBS1040T	MBR1045		207
SBS1045T	MBR1045		207
SBS1620T	MBR1645		215
SBS1630T	MBR1645		215
SBS1635T	MBR1645		215
SBS1640T	MBR1645		215
SBS1645T	MBR1645		215
SBS520T	MBR745		204
SBS530T	MBR745		204
SBS535T	MBR745		204
SBS540T	MBR745		204
SBS545T	MBR745		204
SBS820T		MBR745	204
SBS830T		MBR745	204
SBS835T		MBR745	204
SBS840T		MBR745	204
SBS845T		MBR745	204
SBS850T		MBR1060	212
SBS860T		MBR1060	212
SBYV28-100		MUR420	350

Industry Part Number	ON Semiconductor Nearest Replacement	ON Semiconductor Similar Replacement	Page
SBYV28-150		MUR420	350
SBYV28-200		MUR420	350
SBYV28-50		MUR420	350
SD241P		MBR3045WT	241
SES5001		MUR120	324
SES5002		MUR120	324
SES5003		MUR120	324
SES5301		MUR420	350
SES5302		MUR420	350
SES5303		MUR420	350
SES5401	MUR820		370
SES5401C	MUR1620CT		402
SES5402	MUR820		370
SES5402C	MUR1620CT		402
SES5403	MUR820		370
SES5403C	MUR1620CT		402
SES5404	MUR820		370
SES5404C	MUR1620CT		402
SES5501	MUR1520		393
SES5502	MUR1520		393
SES5503	MUR1520		393
SES5504	MUR1520		393
SF10AG		MUR120	324
SF10BG		MUR120	324
SF10CG		MUR120	324
SF10DG		MUR120	324
SF10FG		MUR160	324
SF10GG		MUR160	324
SF10HG		MUR160	324
SF10JG		MUR160	324
SF30AG		MUR420	350
SF30BG		MUR420	350
SF30CG		MUR420	350
SF30DG		MUR420	350
SF30FG		MUR460	350
SF30GG		MUR460	350
SF30HG		MUR460	350
SF30JG		MUR460	350
SL12		MBRA130LT3	58
SL13		MBRA130LT3	58
SL42		MBRS320T3	94
SL43		MBRS330T3	94
SL44		MBRS340T3	94
SMBYT01-400	MURS140T3		286
SMBYT03-400	MURS340T3		299
SMBYW01-200	MURS120T3		286
SMBYW02-200	MURS120T3		286
SMBYW04-200		MURS320T3	299
SR1002	MBR1045		207
SR1003	MBR1045		207
SR1004	MBR1045		207
SR1005	MBR1060		212
SR1006	MBR1060		212
SR102	MBR160		152
SR103	MBR160		152
SR104	MBR160		152

Industry Part Number	ON Semiconductor Nearest Replacement	ON Semiconductor Similar Replacement	Page
SR105	MBR160		152
SR106	MBR160		152
SR1602		MBR1545CT	174
SR1603		MBR1545CT	174
SR1604		MBR1545CT	174
SR302	MBR340		165
SR303	MBR340		165
SR304	MBR340		165
SR305	MBR360		168
SR306	MBR360		168
SR802		MBR745	204
SR803		MBR745	204
SR804		MBR745	204
SRP100A		1N4933	452
SRP100B		1N4934	452
SRP100D		1N4935	452
SRP100G		1N4936	452
SRP100J	1N4937		452
SRP300A		MR852	454
SRP300B		MR852	454
SRP300D		MR852	454
SRP300G		MR856	454
SRP300J	MR856		454
SS12		MBRA130LT3	58
SS13	MBRA130LT3		58
SS14	MBRA140T3		61
SS210		MBRS1100T3	80
SS24		MBRS240LT3	87
SS25		MBRS1100T3	80
SS26		MBRS1100T3	80
SS28		MBRS1100T3	80
SS29		MBRS1100T3	80
SS32	MBRS320T3		94
SS33	MBRS330T3		94
SS34	MBRS340T3		94
SS35		MBRS360T3	94
SS36	MBRS360T3		94
STPR120A	MRA4003T3		456
STPR120CT		MUR1620CT	402
STPR1520D		MUR1520	393
STPR1620CG		MURB1620CT	313
STPR620CT		MUR620CT	363
STPR820D		MUR820	370
STPS0540Z	MBR0540T1,T3		34
STPS1045D		MBR1045	207
STPS10L25D		MBR1035	207
STPS10L60D		MBR1060	212
STPS130A	MBRA130LT3		58
STPS130U	MBRS130LT3		67
STPS140A	MBRA140T3		61
STPS140U	MBRS140T3		73
STPS140Z		MBR0540T1,T3	34
STPS1545CG	MBRB1545CT		116
STPS1545CT	MBR1545CT		174
STPS1545D		MBR1645	215
STPS15L25D		MBR1635	215

Industry Part Number	ON Semiconductor Nearest Replacement	ON Semiconductor Similar Replacement	Page
STPS160U		MBRS1100T3	80
STPS16L40CT		MBR1545CT	174
STPS1H100U	MBRS1100T3		80
STPS1L30A	MBRA130LT3		58
STPS1L30U	MBRS130LT3		67
STPS1L40A	MBRA140T3		61
STPS1L40U	MBRS140LT3		76
STPS2045CF		MBRF2545CT	229
STPS2045CG		MBRB2060CT	118
STPS2045CT	MBR2045CT		184
STPS2060CT	MBR2060CT		189
STPS20H100CF	MBRF20100CT		223
STPS20H100CG	MBRB20100CT		120
STPS20H100CT	MBR20100CT		189
STPS20L25CT		MBR2030CTL	180
STPS20L40CF		MBRF2545CT	229
STPS20L40CT		MBR2045CT	184
STPS20L60CT	MBR2060CT		189
STPS2H100U		MBRS1100T3	80
STPS2L30A		MBRA130LT3	58
STPS3045CG		MBRB2545CT	130
STPS3045CP	MBR3045PT		232
STPS3045CT		MBR2545CT	198
STPS3045CW	MBR3045WT		241
STPS3045G		MBRB2545CT	130
STPS30L30CG	MBRB3030CTL		136
STPS30L30CT		MBR2535CTL	195
STPS30L40CG		MBRB2545CT	130
STPS30L40CT		MBR2545CT	198
STPS30L40CW		MBR3045WT	241
STPS340S	MBRS340T3		94
STPS340U		MBRS240LT3	87
STPS360B	MBRD360T4		97
STPS3L25S		MBRS330T3	94
STPS3L60S	MBRS360T3		94
STPS4045CP	MBR4045PT		235
STPS4045CW	MBR4045WT		248
STPS40L15CW	MBR4015LWT		244
STPS40L40CW		MBR4045WT	248
STPS40L45CW	MBR4045WT		248
STPS5L25B		MBRD630CTT4	101
STPS6045CP	MBR6045PT		237
STPS6045CW	MBR6045WT		250
STPS60L30CW		MBR6045WT	250
STPS60L40CW		MBR6045WT	250
STPS60L45CW		MBR6045WT	250
STPS640CB	MBRD640CTT4		101
STPS660CB	MBRD660CTT4		101
STPS745D	MBR745		204
STPS8H100D		MBR10100	212
STPS8L30B		MBRD835L	105
STTA106U	MURS160T3		286
STTA206S	MURS360T3		299
TG26	MUR460		350
TG284	MUR1640CT		402
TG286	MUR1660CT		402

Industry Part Number	ON Semiconductor Nearest Replacement	ON Semiconductor Similar Replacement	Page
TG288	MUR1660CT		402
TG4	MUR140		324
TG6	MUR160		324
TG84	MUR840		370
TG86	MUR860		370
UES1001		MUR120	324
UES1002		MUR120	324
UES1003		MUR120	324
UES1101		MUR120	324
UES1102		MUR120	324
UES1103		MUR120	324
UES1104		MUR120	324
UES1105		MUR140	324
UES1106		MUR140	324
UES1301		MUR420	350
UES1302		MUR420	350
UES1303		MUR420	350
UES1304		MUR420	350
UES1401	MUR820		370
UES1402	MUR820		370
UES1403	MUR820		370
UES1404	MUR820		370
UES1420	MUR860		370
UES1501	MUR1520		393
UES1502	MUR1520		393
UES1503	MUR1520		393
UES1504	MUR1520		393
UES2401	MUR1620CT		402
UES2402	MUR1620CT		402
UES2403	MUR1620CT		402
UES2404	MUR1620CT		402
UES2601		MUR3020PT	425
UES2602		MUR3020PT	425
UES2603		MUR3020PT	425
UES2604		MUR3020PT	425
UES2605		MUR3040PT	425
UES2606		MUR3040PT	425
UF1001		MUR120	324
UF1002		MUR120	324
UF1003	MUR120		324
UF1004		MUR160	324
UF1005	MUR160		324
UF1006	MUR180E		329
UF1007	MUR1100E		329
UF1501S		MUR120	324
UF1502S		MUR120	324
UF1503S		MUR120	324
UF1504S		MUR160	324
UF1505S		MUR160	324
UF1506S		MUR180E	329
UF1507S		MUR1100E	329
UF3001		MUR420	350
UF3002		MUR420	350
UF3003		MUR420	350
UF3004		MUR460	350
UF3005		MUR460	350



Industry Part Number	ON Semiconductor Nearest Replacement	ON Semiconductor Similar Replacement	Page
UF3006		MUR480E	355
UF3007		MUR4100E	355
UF4001		MUR120	324
UF4002		MUR120	324
UF4003	MUR120		324
UF4004		MUR160	324
UF4005	MUR160		324
UF4006	MUR180E		329
UF4007	MUR1100E		329
UF5400		MUR420	350
UF5401		MUR420	350
UF5402		MUR420	350
UF5403		MUR460	350
UF5404		MUR460	350
UF5405		MUR460	350
UF5406		MUR460	350
UF5407		MUR480E	355
UF5408		MUR4100E	355
UG1001		MUR120	324
UG1002		MUR120	324
UG1003	MUR120		324
UG1004		MUR160	324
UG1005	MUR160		324
UG18ACT		MUR1620CT	402
UG18BCT		MUR1620CT	402
UG18CCT		MUR1620CT	402
UG18DCT		MUR1620CT	402
UG1A		MUR120	324
UG1B		MUR120	324
UG1C		MUR120	324
UG1D	MUR120		324
UG3001		MUR420	350
UG3002		MUR420	350
UG3003		MUR420	350
UG3004		MUR460	350
UG3005		MUR460	350
UG30APT		MUR3020WT	431
UG30BPT		MUR3020WT	431
UG30CPT		MUR3020WT	431
UG30DPT	MUR3020WT		431
UG4A		MUR420	350
UG4B		MUR420	350
UG4C		MUR420	350
UG4D	MUR420		350
UG8AT		MUR820	370
UG8BT		MUR820	370
UG8CT		MUR820	370
UG8DT	MUR820		370
UPS120		MBRM120LT3	43
UPS120E		MBRM120ET3	38
UPS140		MBRM140T3	53
UPS5817		MBRM120LT3	43
UPS5819		MBRM140T3	53
US1A		MRA4003T3	456
US1B		MRA4003T3	456
US1D	MRA4003T3		456

Industry Part Number	ON Semiconductor Nearest Replacement	ON Semiconductor Similar Replacement	Page
US1G	MRA4004T3		456
US1J	MRA4005T3		456
US1K	MRA4006T3		456
US1M	MRA4007T3		456
USD1120	MBR160		152
USD1130	MBR160		152
USD1140	MBR160		152
USD620	MBR745		204
USD620C	MBR1545CT		174
USD635	MBR745		204
USD635C	MBR1545CT		174
USD640	MBR745		204
USD640C	MBR1545CT		174
USD645	MBR745		204
USD645C	MBR1545CT		174
USD720	MBR1045		207
USD720C	MBR1545CT		174
USD735	MBR1045		207
USD735C	MBR1545CT		174
USD740	MBR1045		207
USD740C	MBR1545CT		174
USD745	MBR1045		207
USD745C	MBR1545CT		174
USD820	MBR1645		215
USD835	MBR1645		215
USD840	MBR1645		215
USD845	MBR1645		215
USD920	MBR1645		215
USD935	MBR1645		215
USD940	MBR1645		215
USD945	MBR1645		215
UT234		1N4003	447
UT235		1N4004	447
UT236		1N4002	447
UT237		1N4005	447
UT238		1N4005	447
UT242		1N4003	447
UT244		1N4004	447
UT245		1N4005	447
UT247		1N4005	447
UT249		1N4002	447
UT251		1N4002	447
UT252		1N4003	447
UT254		1N4004	447
UT255		1N4005	447
UT257		1N4005	447
UT258		1N4006	447
UT347		1N4007	447
UT361		1N4006	447
UT362		1N4006	447
UT363		1N4007	447
UT364		1N4007	447
UTR01		1N4933	452
UTR02		1N4933	452
UTR10		1N4934	452
UTR11		1N4934	452



Industry Part Number	ON Semiconductor Nearest Replacement	ON Semiconductor Similar Replacement	Page
UTR12		1N4934	452
UTR20		1N4935	452
UTR21		1N4935	452
UTR22		1N4935	452
UTR2305		MR852	454
UTR2310		MR852	454
UTR2320		MR852	454
UTR2340		MR856	454
UTR2350		MR856	454
UTR2360		MR856	454
UTR30		1N4936	452
UTR31		1N4936	452
UTR32		1N4936	452
UTR3305		MR852	454
UTR3310		MR852	454
UTR3320		MR852	454
UTR3340		MR856	454
UTR3350		MR856	454
UTR3360		MR856	454
UTR40		1N4936	452
UTR41		1N4936	452
UTR42		1N4936	452
UTR4305		MR852	454
UTR4310		MR852	454
UTR4320		MR852	454
UTR4340		MR852	454
UTR4350		MR856	454
UTR4360		MR856	454
UTR50		1N4937	452
UTR51		1N4937	452
UTR52		1N4937	452
UTR60		1N4937	452
UTR61		1N4937	452
UTR62		1N4937	452
UTX105		1N4933	452
UTX110		1N4934	452
UTX120		1N4935	452
UTX125		1N4935	452
UTX205		1N4933	452
UTX210		1N4934	452
UTX215		1N4935	452
UTX220		1N4935	452
UTX225		1N4935	452
UTX3105		MR852	454
UTX3110		MR852	454
UTX3115		MR852	454
UTX3120		MR852	454
UTX4105		MR852	454
UTX4110		MR852	454
UTX4115		MR852	454
UTX4120		MR852	454
V322	1N5402		449
V324	1N5404		449
V326	1N5406		449

Industry Part Number	ON Semiconductor Nearest Replacement	ON Semiconductor Similar Replacement	Page
V330X	MR852		454
V331X	MR852		454
V332X	MR852		454
V334X	MR856		454
V336X	MR856		454
V342	1N5402		449
V344	1N5404		449
V346	1N5406		449
V350X	MR852		454
V351X	MR852		454
V352X	MR852		454
V354X	MR856		454
V356X	MR856		454
VHE1401		MUR820	370
VHE1402		MUR820	370
VHE1403		MUR820	370
VHE1404		MUR820	370
VHE205	MUR120		324
VHE210	MUR120		324
VHE215	MUR120		324
VHE220	MUR120		324
VHE2401		MUR1620CT	402
VHE2402		MUR1620CT	402
VHE2403		MUR1620CT	402
VHE2404		MUR1620CT	402
VHE605	MUR420		350
VHE610	MUR420		350
VHE615	MUR420		350
VHE620	MUR420		350
VSK1020	MBR1045		207
VSK1035	MBR1045		207
VSK1045	MBR1045		207
VSK12	MBR1545CT		174
VSK120		1N5817	146
VSK13	MBR1545CT		174
VSK130		1N5818	146
VSK14	MBR1545CT		174
VSK140		1N5819	146
VSK2004	MBRP20060CT		270
VSK2020	MBR2045CT		184
VSK2035	MBR2045CT		184
VSK2045	MBR2045CT		184
VSK2420	MBR2545CT		198
VSK2435	MBR2545CT		198
VSK2445	MBR2545CT		198
VSK320	MBR340		165
VSK330	MBR340		165
VSK340	MBR340		165
VSK62	MBR745		204
VSK63	MBR745		204
VSK64	MBR745		204
VSK920		MBR1545CT	174
VSK935		MBR1545CT	174
VSK945		MBR1545CT	174