

MC74HC240A

Octal 3-State Inverting Buffer/Line Driver/Line Receiver

High-Performance Silicon-Gate CMOS

The MC74HC240A is identical in pinout to the LS240. The device inputs are compatible with standard CMOS outputs; with pullup resistors, they are compatible with LSTTL outputs.

This octal noninverting buffer/line driver/line receiver is designed to be used with 3-state memory address drivers, clock drivers, and other sub-oriented systems. The device has inverting outputs and two active-low output enables.

The HC240A is similar in function to the HC244A.

- Output Drive Capability: 15 LSTTL Loads
- Outputs Directly Interface to CMOS, NMOS, and TTL
- Operating Voltage Range: 2 to 6 V
- Low Input Current: 1 μ A
- High Noise Immunity Characteristic of CMOS Devices
- In Compliance with the Requirements Defined by JEDEC Standard No. 7A
- Chip Complexity: 120 FETs or 30 Equivalent Gates

LOGIC DIAGRAM

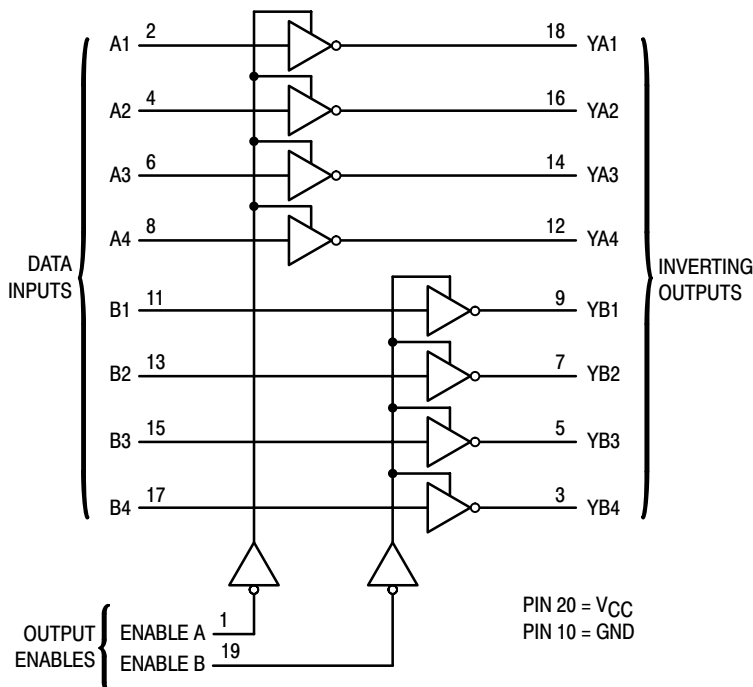

FUNCTION TABLE

Inputs		Outputs
Enable A, Enable B	A, B	YA, YB
L	L	H
L	H	L
H	X	Z

Z = high impedance



ON Semiconductor

<http://onsemi.com>

MARKING DIAGRAMS

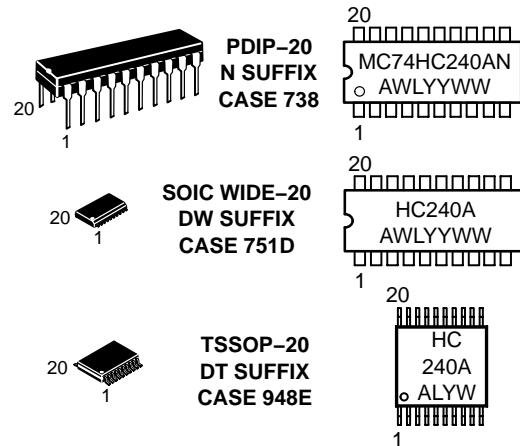

A = Assembly Location
 WL = Wafer Lot
 YY = Year
 WW = Work Week

PIN ASSIGNMENT

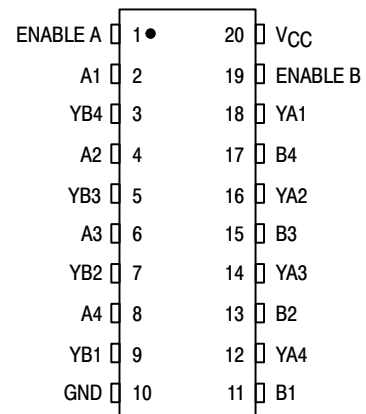

ORDERING INFORMATION

Device	Package	Shipping
MC74HC240AN	PDIP-20	1440 / Box
MC74HC240ADW	SOIC-WIDE	38 / Rail
MC74HC240ADWR2	SOIC-WIDE	1000 / Reel
MC74HC240ADT	TSSOP-20	75 / Rail
MC74HC240ADTR2	TSSOP-20	2500 / Reel

MC74HC240A

MAXIMUM RATINGS*

Symbol	Parameter	Value	Unit
V _{CC}	DC Supply Voltage (Referenced to GND)	- 0.5 to + 7.0	V
V _{in}	DC Input Voltage (Referenced to GND)	- 0.5 to V _{CC} + 0.5	V
V _{out}	DC Output Voltage (Referenced to GND)	- 0.5 to V _{CC} + 0.5	V
I _{in}	DC Input Current, per Pin	± 20	mA
I _{out}	DC Output Current, per Pin	± 35	mA
I _{CC}	DC Supply Current, V _{CC} and GND Pins	± 75	mA
PD	Power Dissipation in Still Air, Plastic DIP† SOIC Package† TSSOP Package†	750 500 450	mW
T _{stg}	Storage Temperature	- 65 to + 150	C
T _L	Lead Temperature, 1 mm from Case for 10 Seconds (Plastic DIP, SOIC or TSSOP Package)	260	C

This device contains protection circuitry to guard against damage due to high static voltages or electric fields. However, precautions must be taken to avoid applications of any voltage higher than maximum rated voltages to this high-impedance circuit. For proper operation, V_{in} and V_{out} should be constrained to the range GND ≤ (V_{in} or V_{out}) ≤ V_{CC}. Unused inputs must always be tied to an appropriate logic voltage level (e.g., either GND or V_{CC}). Unused outputs must be left open.

*Maximum Ratings are those values beyond which damage to the device may occur.

Functional operation should be restricted to the Recommended Operating Conditions.

†Derating — Plastic DIP: - 10 mW/ C from 65 to 125 C

SOIC Package: - 7 mW/ C from 65 to 125 C

TSSOP Package: - 6.1 mW/ C from 65 to 125 C

For high frequency or heavy load considerations, see Chapter 2 of the ON Semiconductor High-Speed CMOS Data Book (DL129/D).

RECOMMENDED OPERATING CONDITIONS

Symbol	Parameter	Min	Max	Unit	
V _{CC}	DC Supply Voltage (Referenced to GND)	2.0	6.0	V	
V _{in} , V _{out}	DC Input Voltage, Output Voltage (Referenced to GND)	0	V _{CC}	V	
T _A	Operating Temperature, All Package Types	- 55	+ 125	C	
t _r , t _f	Input Rise and Fall Time (Figure 1)	V _{CC} = 2.0 V V _{CC} = 4.5 V V _{CC} = 6.0 V	0 0 0	1000 500 400	ns

DC ELECTRICAL CHARACTERISTICS (Voltages Referenced to GND)

Symbol	Parameter	Test Conditions	V _{CC} V	Guaranteed Limit			Unit
				- 55 to 25 C	≤ 85 C	≤ 125 C	
V _{IH}	Minimum High-Level Input Voltage	V _{out} = V _{CC} - 0.1 V I _{out} ≤ 20 μA	2.0	1.5	1.5	1.5	V
			3.0	2.1	2.1	2.1	
			4.5	3.15	3.15	3.15	
			6.0	4.2	4.2	4.2	
V _{IL}	Maximum Low-Level Input Voltage	V _{out} = 0.1 V I _{out} ≤ 20 μA	2.0	0.5	0.5	0.5	V
			3.0	0.9	0.9	0.9	
			4.5	1.35	1.35	1.35	
			6.0	1.8	1.8	1.8	
V _{OH}	Minimum High-Level Output Voltage	V _{in} = V _{IH} I _{out} ≤ 20 μA	2.0	1.9	1.9	1.9	V
			4.5	4.4	4.4	4.4	
			6.0	5.9	5.9	5.9	
		V _{in} = V _{IH} I _{out} ≤ 2.4 mA I _{out} ≤ 6.0 mA I _{out} ≤ 7.8 mA	3.0	2.48	2.34	2.2	
			4.5	3.98	3.84	3.7	
			6.0	5.48	5.34	5.2	
V _{OL}	Maximum Low-Level Output Voltage	V _{in} = V _{IL} I _{out} ≤ 20 μA	2.0	0.1	0.1	0.1	V
			4.5	0.1	0.1	0.1	
			6.0	0.1	0.1	0.1	
		V _{in} = V _{IL} I _{out} ≤ 2.4 mA I _{out} ≤ 6.0 mA I _{out} ≤ 7.8 mA	3.0	0.26	0.33	0.4	
			4.5	0.26	0.33	0.4	
			6.0	0.26	0.33	0.4	

MC74HC240A

DC ELECTRICAL CHARACTERISTICS (Voltages Referenced to GND)

Symbol	Parameter	Test Conditions	V _{CC} V	Guaranteed Limit			Unit
				- 55 to 25 C	≤ 85 C	≤ 125 C	
I _{in}	Maximum Input Leakage Current	V _{in} = V _{CC} or GND	6.0	± 0.1	± 1.0	± 1.0	μA
I _{OZ}	Maximum Three-State Leakage Current	Output in High-Impedance State V _{in} = V _{IL} or V _{IH} V _{out} = V _{CC} or GND	6.0	± 0.5	± 5.0	± 10	μA
I _{CC}	Maximum Quiescent Supply Current (per Package)	V _{in} = V _{CC} or GND I _{out} = 0 μA	6.0	4.0	40	160	μA

NOTE: Information on typical parametric values can be found in Chapter 2 of the ON Semiconductor High-Speed CMOS Data Book (DL129/D).

AC ELECTRICAL CHARACTERISTICS (C_L = 50 pF, Input t_r = t_f = 6 ns)

Symbol	Parameter	V _{CC} V	Guaranteed Limit			Unit
			- 55 to 25 C	≤ 85 C	≤ 125 C	
t _{PLH} , t _{PHL}	Maximum Propagation Delay, A to YA or B to YB (Figures 1 and 3)	2.0 3.0 4.5 6.0	80 40 16 14	100 50 20 17	120 60 24 20	ns
t _{PLZ} , t _{PHZ}	Maximum Propagation Delay, Output Enable to YA or YB (Figures 2 and 4)	2.0 3.0 4.5 6.0	110 60 22 19	140 70 28 24	165 80 33 28	ns
t _{PZL} , t _{PZH}	Maximum Propagation Delay, Output Enable to YA or YB (Figures 2 and 4)	2.0 3.0 4.5 6.0	110 60 22 19	140 70 28 24	165 80 33 28	ns
t _{TLH} , t _{THL}	Maximum Output Transition Time, Any Output (Figures 1 and 3)	2.0 3.0 4.5 6.0	60 23 12 10	75 27 15 13	90 32 18 15	ns
C _{in}	Maximum Input Capacitance	—	10	10	10	pF
C _{out}	Maximum Three-State Output Capacitance (Output in High-Impedance State)	—	15	15	15	pF

NOTE: For propagation delays with loads other than 50 pF, and information on typical parametric values, see Chapter 2 of the ON Semiconductor High-Speed CMOS Data Book (DL129/D).

C _{PD}	Power Dissipation Capacitance (Per Transceiver Channel)*	Typical @ 25°C, V _{CC} = 5.0 V	
		32	

* Used to determine the no-load dynamic power consumption: P_D = C_{PD} V_{CC}²f + I_{CC} V_{CC}. For load considerations, see Chapter 2 of the ON Semiconductor High-Speed CMOS Data Book (DL129/D).

MC74HC240A

SWITCHING WAVEFORMS

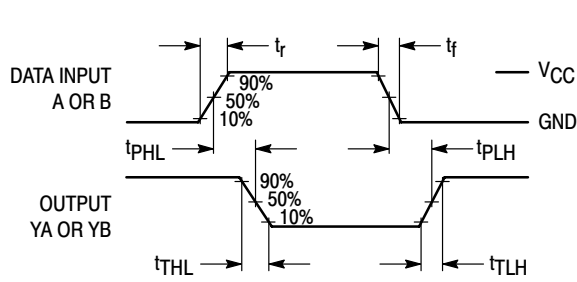

Figure 1.

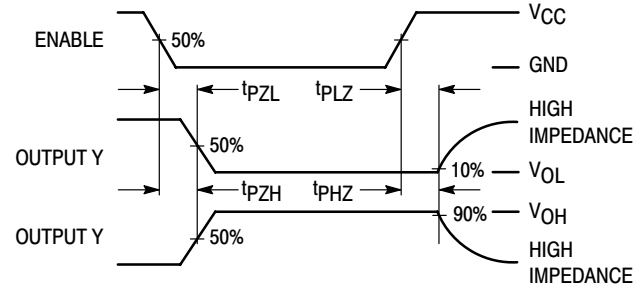
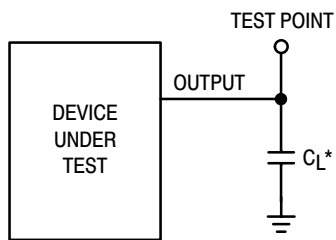
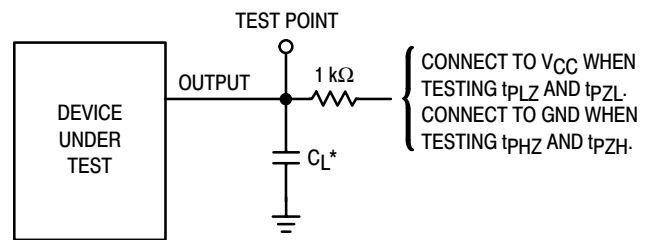

Figure 2.



*Includes all probe and jig capacitance

Figure 3. Test Circuit



*Includes all probe and jig capacitance

Figure 4. Test Circuit

PIN DESCRIPTIONS

INPUTS

A1, A2, A3, A4, B1, B2, B3, B4
(Pins 2, 4, 6, 8, 11, 13, 15, 17)

Data input pins. Data on these pins appear in inverted form on the corresponding Y outputs, when the outputs are enabled.

CONTROLS

Enable A, Enable B (Pins 1, 19)

Output enables (active-low). When a low level is applied to these pins, the outputs are enabled and the devices

function as inverters. When a high level is applied, the outputs assume the high-impedance state.

OUTPUTS

YA1, YA2, YA3, YA4, YB1, YB2, YB3, YB4
(Pins 18, 16, 14, 12, 9, 7, 5, 3)

Device outputs. Depending upon the state of the output-enable pins, these outputs are either inverting outputs or high-impedance outputs.

MC74HC240A

LOGIC DETAIL

