

3 Half-Bridge Gate-Drive IC

FAN7888



SOIC-20, 300 mils
CASE 751BJ-01

Description

The FAN7888 is a monolithic three half-bridge gate-drive IC designed for high-voltage, high-speed driving MOSFETs and IGBTs operating up to +200 V.

onsemi's high-voltage process and common-mode noise canceling technique provide stable operation of high-side drivers under high-dv/dt noise circumstances.

An advanced level-shift circuit allows high-side gate driver operation up to $V_S = -9.8$ V (typical) for $V_{BS} = 15$ V.

The UVLO circuits prevent malfunction when V_{DD} and V_{BS} are lower than the specified threshold voltage.

Output drivers typically source/sink 350 mA / 650 mA, respectively, which is suitable for three-phase half-bridge applications in motor drive systems.

Features

- Floating Channel for Bootstrap Operation to +200 V
- Typically 350 mA / 650 mA Sourcing/Sinking Current Driving Capability for All Channels
- 3 Half-Bridge Gate Driver
- Extended Allowable Negative V_S Swing to -9.8 V for Signal Propagation at $V_{BS} = 15$ V
- Matched Propagation Delay Time Maximum: 50 ns
- 3.3 V and 5 V Input Logic Compatible
- Built-in Shoot-Through Prevention Circuit for All Channels with 270 ns Typical Dead Time
- Built-in Common Mode dv/dt Noise Canceling Circuit
- Built-in UVLO Functions for All Channels
- This Device is Pb-Free, Halide Free and is RoHS Compliant

Applications

- Battery Based Motor Applications (E-bike, Power Tool)
- 3-Phase Motor Inverter Driver

Related Resources

- [AN-6076](#) – Design and Application Guide of Bootstrap Circuit for High-Voltage Gate-Drive IC
- [AN-9052](#) – Design Guide for Selection of Bootstrap Components
- [AN-8102](#) – Recommendations to Avoid Short Pulse Width Issues in HVIC Gate Driver Applications

MARKING DIAGRAM

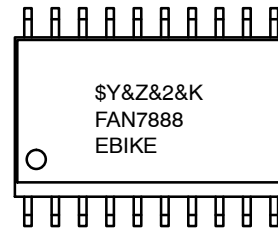

- \$Y = Logo
- &Z = Assembly Plant Code
- &2 = 2-Digit Date Code
- &K = 2-Digits Lot Run Traceability Code
- FAN7888 = Specific Device Code
- EBIKE = 3rd Line Marking

ORDERING INFORMATION

See detailed ordering and shipping information on page 13 of this data sheet.

FAN7888

TYPICAL APPLICATION CIRCUIT

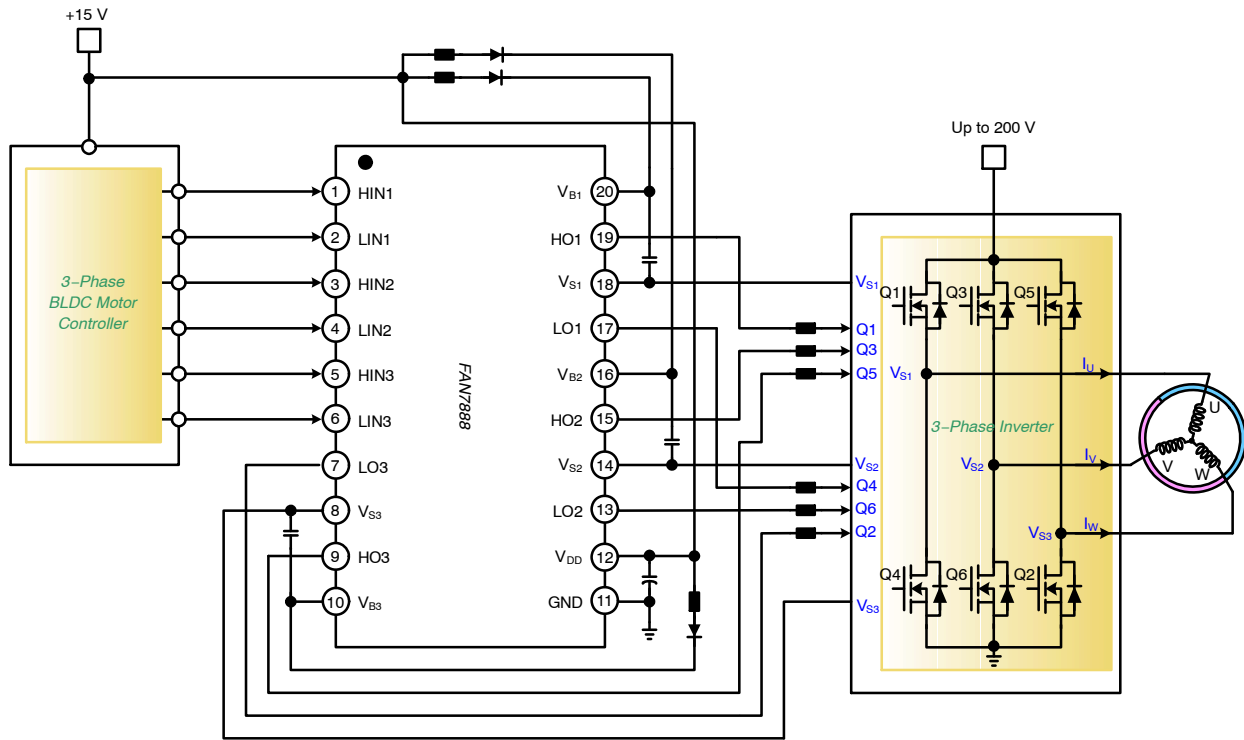

Figure 1. 3-Phase BLDC Motor Drive Application

FAN7888

INTERNAL BLOCK DIAGRAM

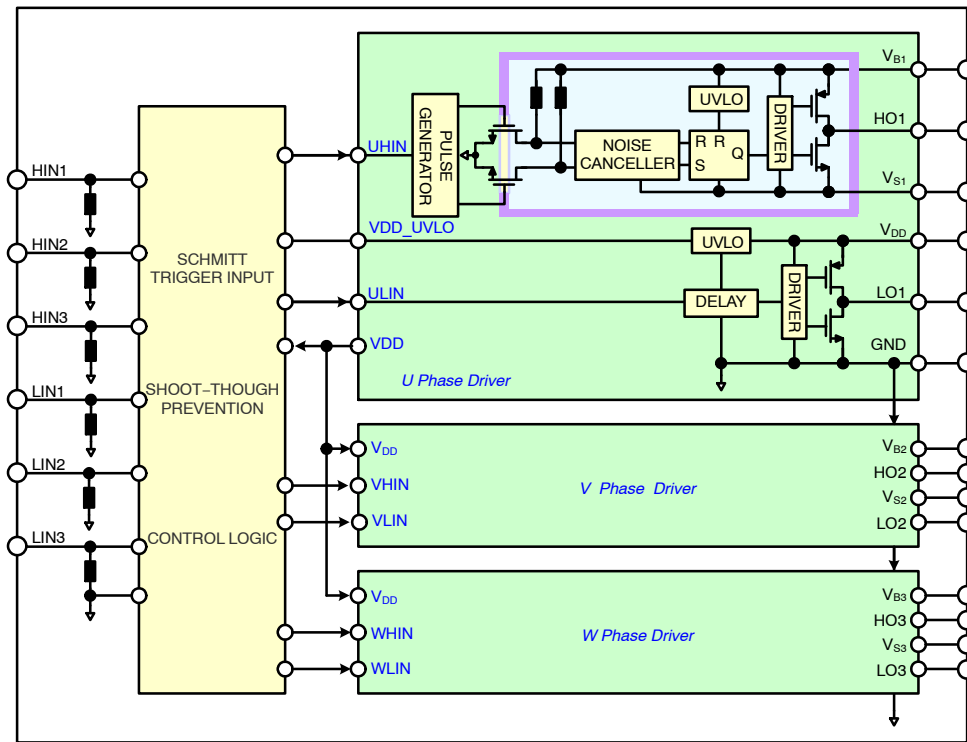

Figure 2. Functional Block Diagram

FAN7888

PIN CONFIGURATION

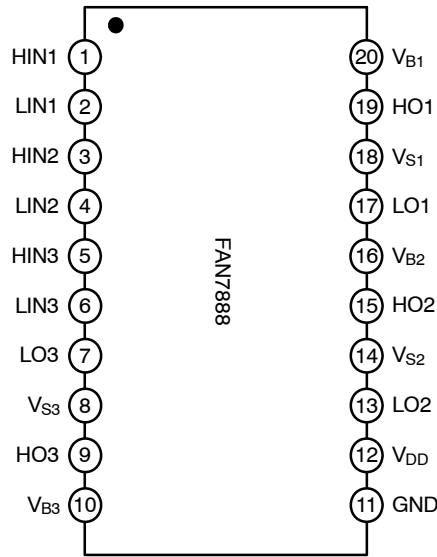

Figure 3. Pin Configuration (Top View)

PIN DEFINITIONS

Pin No.	Name	Description
1	HIN1	Logic input 1 for high-side gate 1 driver
2	LIN1	Logic input 1 for low-side gate 1 driver
3	HIN2	Logic input 2 for high-side gate 2 driver
4	LIN2	Logic input 2 for low-side gate 2 driver
5	HIN3	Logic input 3 for high-side gate 3 driver
6	LIN3	Logic input 3 for low-side gate 3 driver
7	LO3	Low-side gate driver 3 output
8	V_{S3}	High-side driver 3 floating supply offset voltage
9	HO3	High-side driver 3 gate driver output
10	V_{B3}	High-side driver 3 floating supply voltage
11	GND	Ground
12	V_{DD}	Logic and all low-side gate drivers power supply voltage
13	LO2	Low-side gate driver 2 output
14	V_{S2}	High-side driver 2 floating supply offset voltage
15	HO2	High-side driver 2 gate driver output
16	V_{B2}	High-side driver 2 floating supply voltage
17	LO1	Low-side gate driver 1 output
18	V_{S1}	High-side driver 1 floating supply offset voltage
19	HO1	High-side driver 1 gate driver output
20	V_{B1}	High-side driver 1 floating supply voltage

FAN7888

ABSOLUTE MAXIMUM RATINGS (T_A = 25°C unless otherwise specified)

Symbol	Parameter	Min	Max	Unit
V _B	High-Side Floating Supply Voltage of V _{B1,2,3}	-0.3	225.0	V
V _S	High-Side Floating Supply Offset Voltage of V _{S1,2,3}	V _{B1,2,3} - 25	V _{B1,2,3} + 0.3	V
V _{HO1,2,3}	High-Side Floating Output Voltage	V _{S1,2,3} - 0.3	V _{B1,2,3} + 0.3	V
V _{DD}	Low-Side and Logic-fixed Supply Voltage	-0.3	25.0	V
V _{LO1,2,3}	Low-Side Output Voltage	-0.3	V _{DD} + 0.3	V
V _{IN}	Logic Input Voltage (HIN1,2,3 and LIN1,2,3)	-0.3	V _{DD} + 0.3	V
dV _S /dt	Allowable Offset Voltage Slew Rate	-	50	V/ns
P _D	Power Dissipation (Note 1) (Note 2) (Note 3)	-	1.47	W
θ _{JA}	Thermal Resistance, Junction-to-ambient	-	85	°C/W
T _J	Junction Temperature	-	+150	°C
T _{STG}	Storage Temperature	-55	+150	°C

Stresses exceeding those listed in the Maximum Ratings table may damage the device. If any of these limits are exceeded, device functionality should not be assumed, damage may occur and reliability may be affected.

1. Mounted on 76.2 x 114.3 x 1.6 mm PCB (FR-4 glass epoxy material).
2. Refer to the following standards:
 JESD51-2: Integral circuits thermal test method environmental conditions – natural convection.
 JESD51-3: Low effective thermal conductivity test board for leaded surface-mount packages.
3. Do not exceed P_D under any circumstances.

RECOMMENDED OPERATING CONDITIONS

Symbol	Parameter	Min	Max	Unit
V _{B1,2,3}	High-Side Floating Supply Voltage	V _{S1,2,3} + 10	V _{S1,2,3} + 20	V
V _{S1,2,3}	High-Side Floating Supply Offset Voltage	6 - V _{DD}	200	V
V _{DD}	Supply Voltage	10	20	V
V _{HO1,2,3}	High-Side Output Voltage	V _{S1,2,3}	V _{B1,2,3}	V
V _{LO1,2,3}	Low-Side Output Voltage	GND	V _{DD}	V
V _{IN}	Logic Input Voltage (HIN1,2,3 and LIN1,2,3)	GND	V _{DD}	V
T _A	Ambient Temperature	-40	+125	°C

Functional operation above the stresses listed in the Recommended Operating Ranges is not implied. Extended exposure to stresses beyond the Recommended Operating Ranges limits may affect device reliability.

FAN7888

ELECTRICAL CHARACTERISTICS (V_{BIAS} (V_{DD} , $V_{BS1,2,3}$) = 15.0 V, T_A = 25°C, unless otherwise specified. The V_{IN} and I_{IN} parameters are referenced to GND. The V_O and I_O parameters are referenced to GND and $V_{S1,2,3}$ and are applicable to the respective outputs LO1,2,3 and HO1,2,3.)

Symbol	Characteristics	Condition	Min	Typ	Max	Unit
--------	-----------------	-----------	-----	-----	-----	------

LOW-SIDE POWER SUPPLY SECTION

I_{QDD}	Quiescent V_{DD} Supply Current	$V_{LIN1,2,3} = 0$ V or 5 V	–	160	350	μ A
$I_{PDD1,2,3}$	Operating V_{DD} Supply Current for each Channel	$f_{LIN1,2,3} = 20$ kHz, rms Value	–	500	900	μ A
V_{DDUV+}	V_{DD} Supply Under-Voltage Positive-Going Threshold	$V_{DD} =$ Sweep, $V_{BS} = 15$ V	7.2	8.2	9.0	V
V_{DDUV-}	V_{DD} Supply Under-Voltage Negative-Going Threshold	$V_{DD} =$ Sweep, $V_{BS} = 15$ V	6.8	7.8	8.5	V
V_{DDHYS}	V_{DD} Supply Under-Voltage Lockout Hysteresis	$V_{DD} =$ Sweep, $V_{BS} = 15$ V	–	0.4	–	V

BOOTSTRAPPED POWER SUPPLY SECTION

$I_{QBS1,2,3}$	Quiescent V_{BS} Supply Current for each Channel	$V_{HIN1,2,3} = 0$ V or 5 V	–	50	120	μ A
$I_{PBS1,2,3}$	Operating V_{BS} Supply Current for each Channel	$f_{HIN1,2,3} = 20$ kHz, rms Value	–	400	800	μ A
V_{BSUV+}	V_{BS} Supply Under-Voltage Positive-going Threshold	$V_{DD} = 15$ V, $V_{BS} =$ Sweep	7.2	8.2	9.0	V
V_{BSUV-}	V_{BS} Supply Under-Voltage Negative-going Threshold	$V_{DD} = 15$ V, $V_{BS} =$ Sweep	6.8	7.8	8.5	V
V_{BSHYS}	V_{BS} Supply Under-Voltage Lockout Hysteresis	$V_{DD} = 15$ V, $V_{BS} =$ Sweep	–	0.4	–	V
I_{LK}	Offset Supply Leakage Current	$V_{B1,2,3} = V_{S1,2,3} = 200$ V	–	–	10	μ A

GATE DRIVER OUTPUT SECTION

V_{OH}	High-Level Output Voltage, $V_{BIAS}-V_O$	$I_O=20$ mA	–	–	1.0	V
V_{OL}	Low-Level Output Voltage, V_O	$I_O=20$ mA	–	–	0.6	V
I_{O+}	Output HIGH Short-Circuit Pulsed Current (Note 4)	$V_O = 0$ V, $V_{IN} = 5$ V with PW < 10 μ s	250	350	–	mA
I_{O-}	Output LOW Short-Circuit Pulsed Current (Note 4)	$V_O = 15$ V, $V_{IN} = 0$ V with PW < 10 μ s	500	650	–	mA
V_S	Allowable Negative V_S Pin Voltage for IN Signal Propagation to H_O		–	–9.8	–7.0	V

LOGIC INPUT SECTION (HIN, LIN)

V_{IH}	Logic "1" Input Voltage		2.5	–	–	V
V_{IL}	Logic "0" Input Voltage		–	–	1.0	V
I_{IN+}	Logic "1" Input Bias Current	$V_{IN} = 5$ V	–	25	50	μ A
I_{IN-}	Logic "0" Input Bias Current (Note 4)	$V_{IN} = 0$ V	–	–	2.0	μ A
R_{IN}	Input Pull-Down Resistance		100	200	300	k Ω

Product parametric performance is indicated in the Electrical Characteristics for the listed test conditions, unless otherwise noted. Product performance may not be indicated by the Electrical Characteristics if operated under different conditions.

4. This parameter is guaranteed by design.

DYNAMIC ELECTRICAL CHARACTERISTICS (T_A = 25°C, V_{BIAS} (V_{DD} , $V_{BS1,2,3}$) = 15.0 V, $V_{S1,2,3}$ = GND, C_{Load} = 1000 pF unless otherwise specified.)

Symbol	Parameter	Condition	Min	Typ	Max	Unit
t_{ON}	Turn-on Propagation Delay	$V_{S1,2,3} = 0$ V	–	130	220	ns
t_{OFF}	Turn-off Propagation Delay	$V_{S1,2,3} = 0$ V	–	150	240	ns
t_R	Turn-on Rise Time		–	50	120	ns
t_F	Turn-off Fall Time		–	30	80	ns
MT1	Turn-on Delay Matching $t_{ON(H)} - t_{OFF(L)}$		–	–	50	ns
MT2	Turn-off Delay Matching $t_{OFF(H)} - t_{ON(L)}$		–	–	50	ns
DT	Dead Time		100	270	440	ns
MDT	Dead-time Matching $t_{DT1} - t_{DT2}$		–	–	60	ns

TYPICAL CHARACTERISTICS

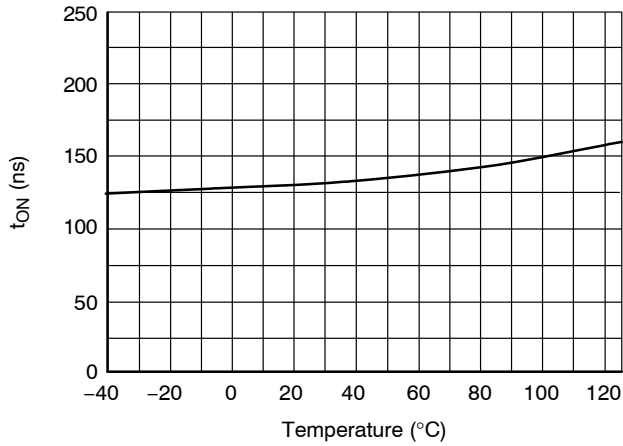

Figure 4. Turn-on Propagation Delay vs. Temperature

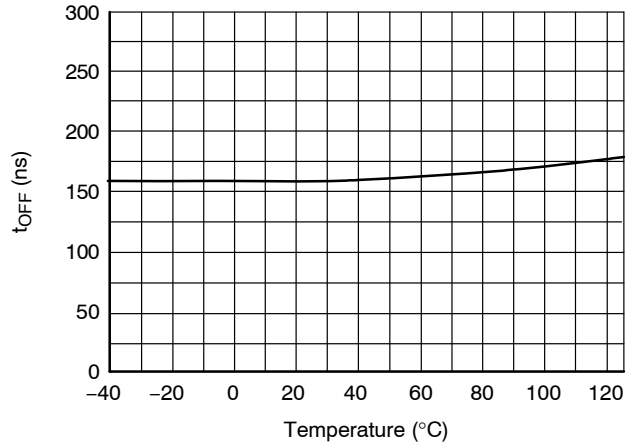

Figure 5. Turn-off Propagation Delay vs. Temperature

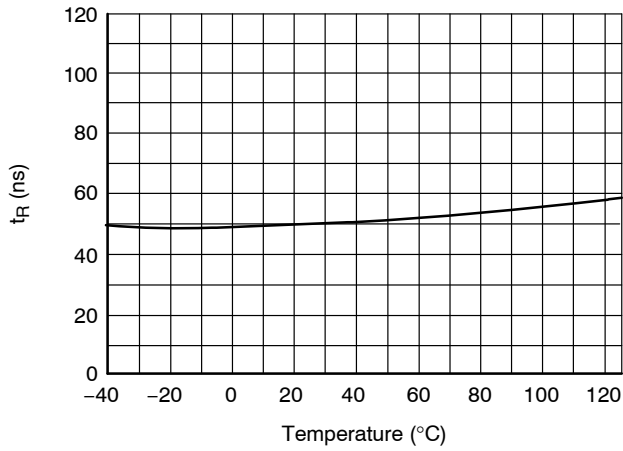

Figure 6. Turn-on Rise Time vs. Temperature

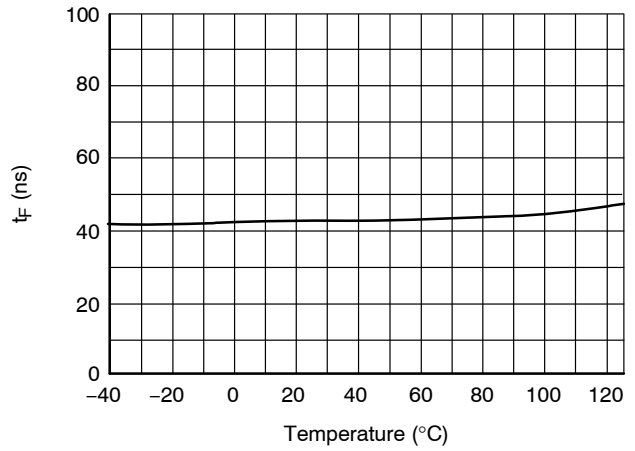

Figure 7. Turn-off Fall Time vs. Temperature

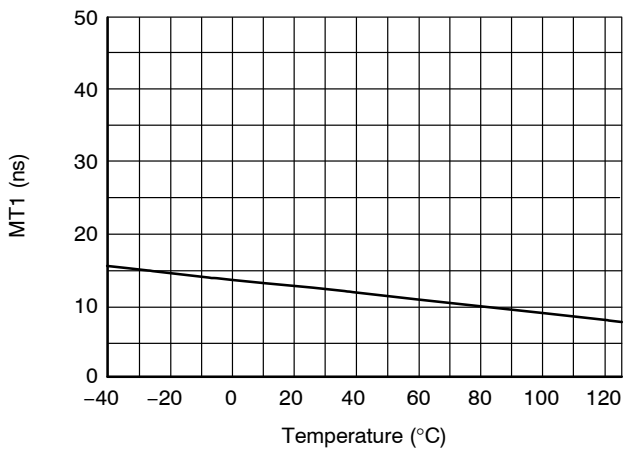

Figure 8. Turn-on Delay Matching vs. Temperature

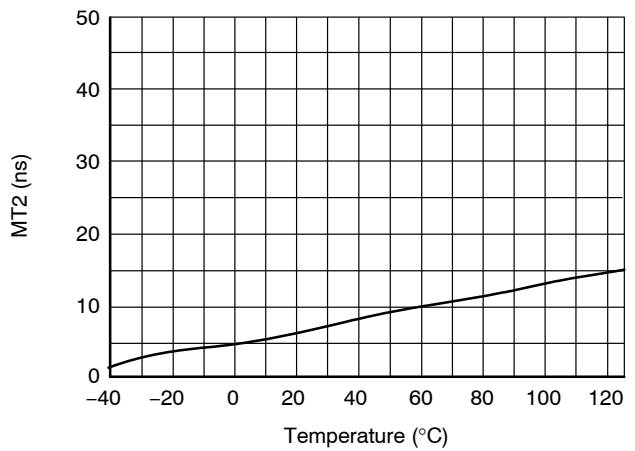

Figure 9. Turn-off Delay Matching vs. Temperature

TYPICAL CHARACTERISTICS (continued)

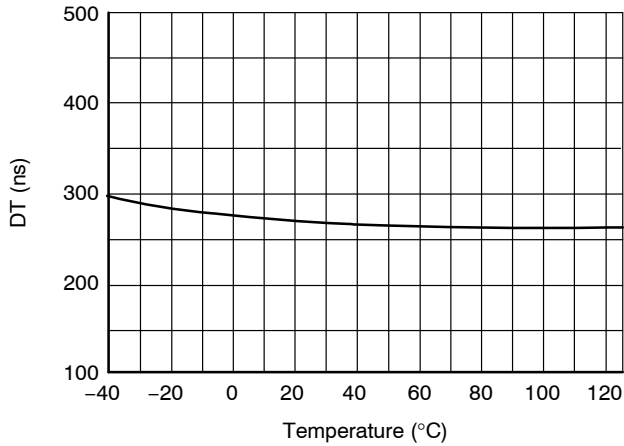

Figure 10. Dead Time vs. Temperature

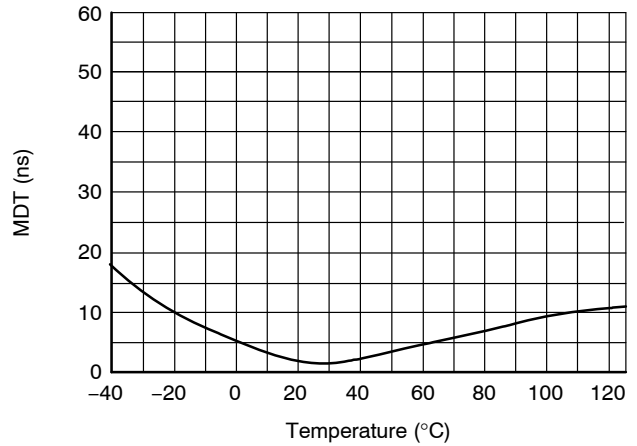

Figure 11. Dead-Time Matching vs. Temperature

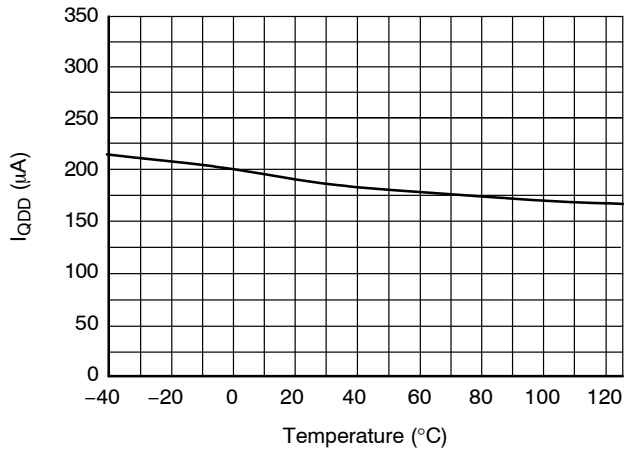

Figure 12. Quiescent V_{DD} Supply Current vs. Temperature

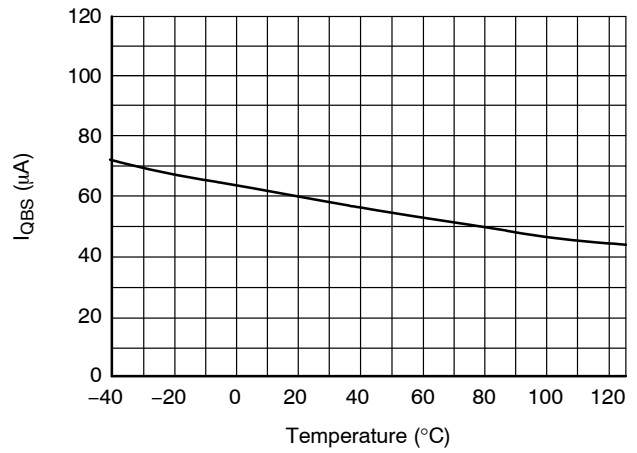

Figure 13. Quiescent V_{BS} Supply Current vs. Temperature

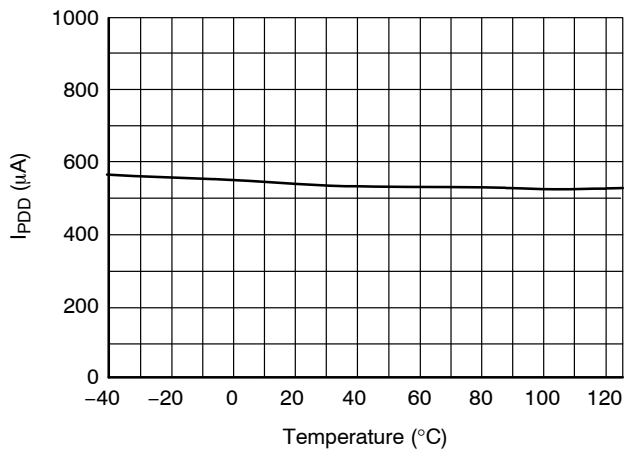

Figure 14. Operating V_{DD} Supply Current vs. Temperature

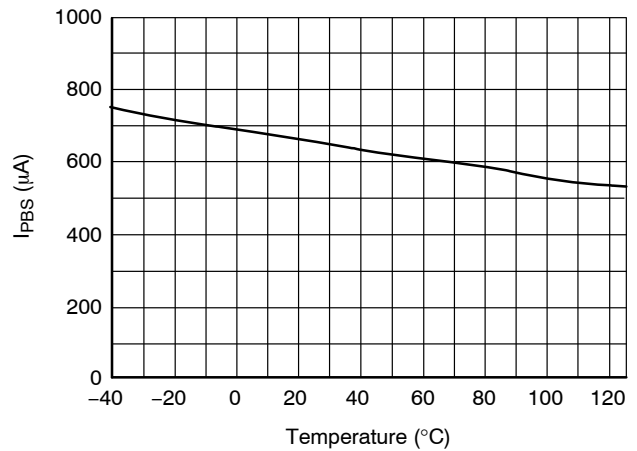

Figure 15. Operating V_{BS} Supply Current vs. Temperature

TYPICAL CHARACTERISTICS (continued)

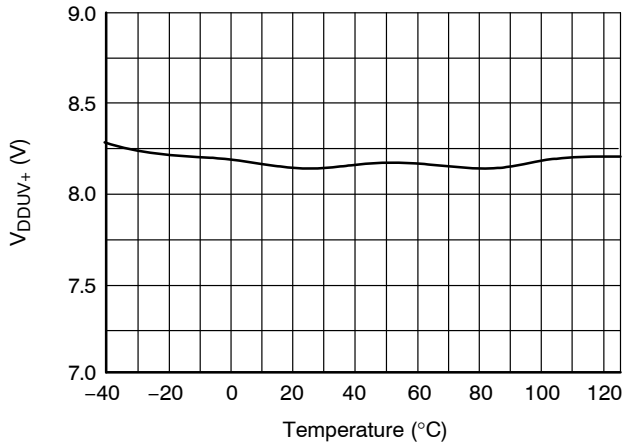

Figure 16. V_{DD} UVLO+ vs. Temperature

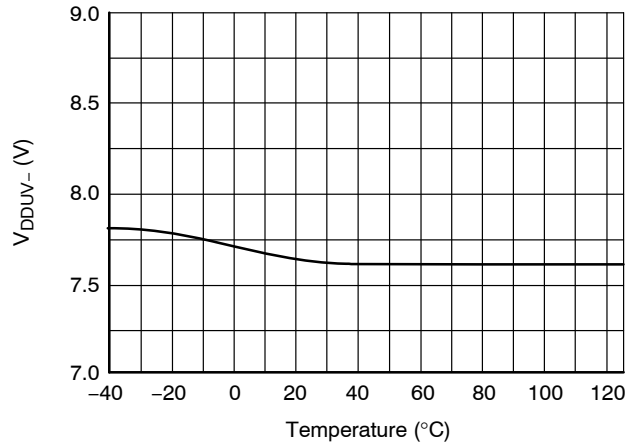

Figure 17. V_{DD} UVLO- vs. Temperature

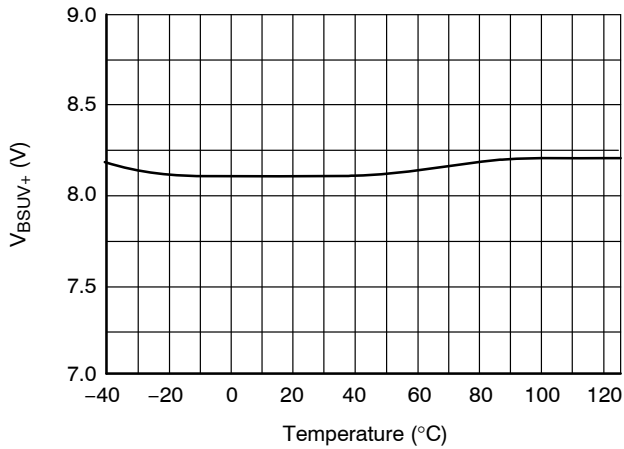

Figure 18. V_{BS} UVLO+ vs. Temperature

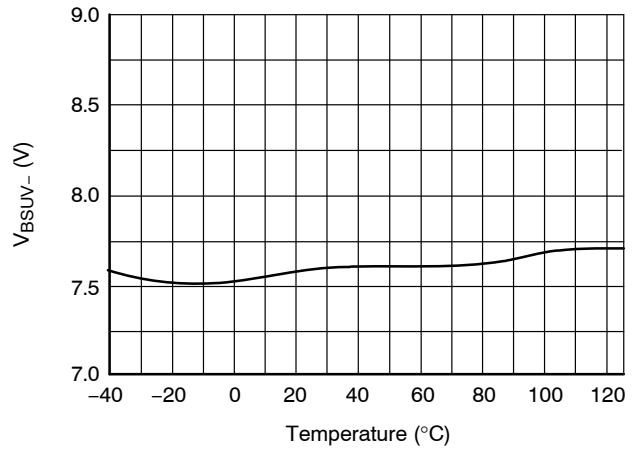

Figure 19. V_{BS} UVLO- vs. Temperature

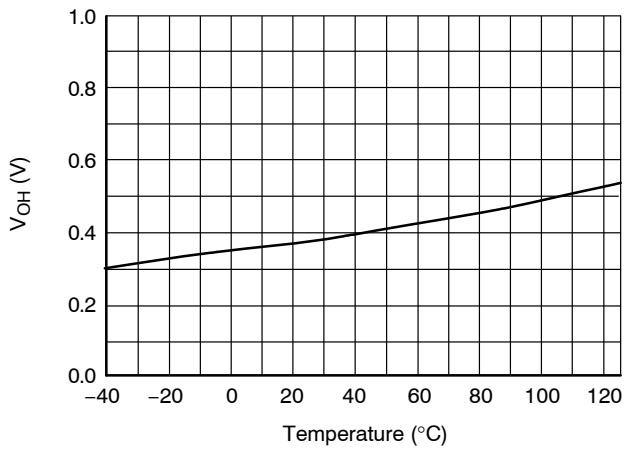

Figure 20. High-Level Output Voltage vs. Temperature

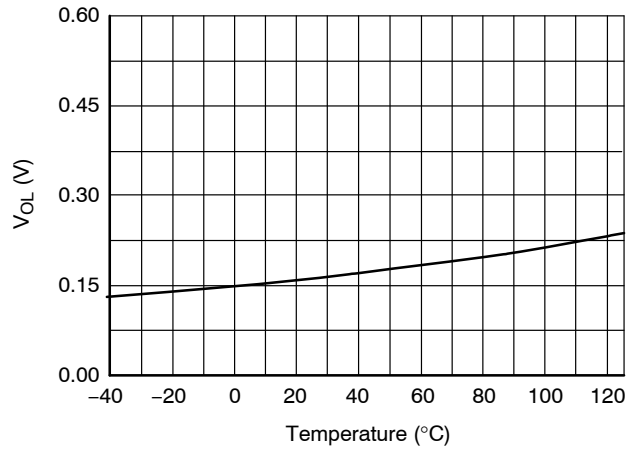

Figure 21. Low-Level Output Voltage vs. Temperature

TYPICAL CHARACTERISTICS (continued)

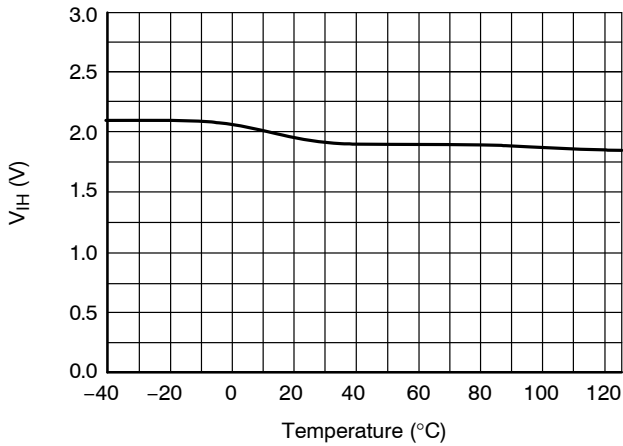

Figure 22. Logic High Input Voltage vs. Temperature

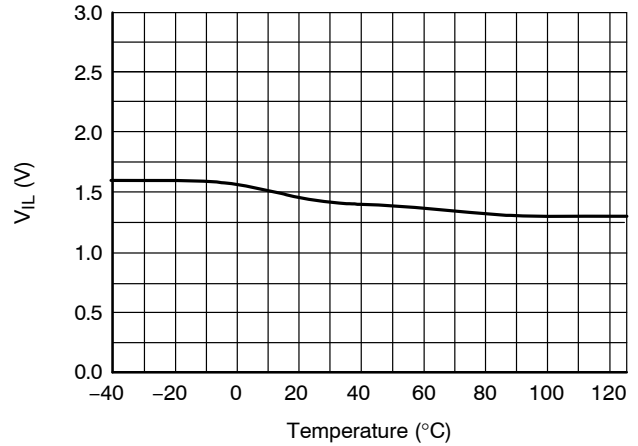

Figure 23. Logic Low Input Voltage vs. Temperature

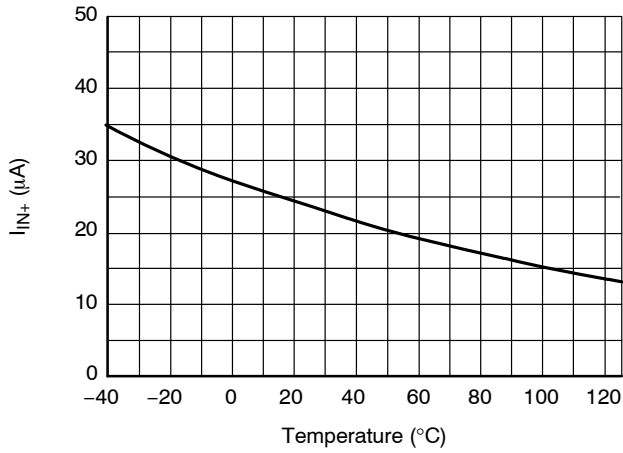

Figure 24. Logic Input High Bias Current vs. Temperature

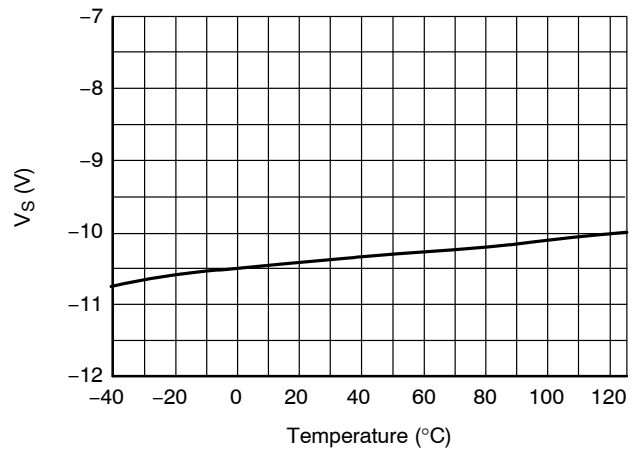

Figure 25. Allowable Negative V_S Voltage vs. Temperature

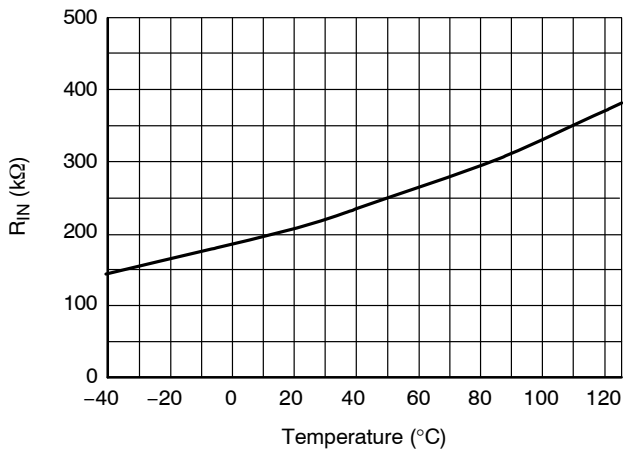

Figure 26. Input Pull-down Resistance vs. Temperature

APPLICATION INFORMATION

Protection Function

Under-Voltage Lockout (UVLO)

The high- and low-side drivers include under-voltage lockout (UVLO) protection circuitry for each channel that monitors the supply voltage (V_{DD}) and bootstrap capacitor voltage ($V_{BS1,2,3}$) independently. It can be designed prevent malfunction when V_{DD} and $V_{BS1,2,3}$ are lower than the specified threshold voltage. The UVLO hysteresis prevents chattering during power supply transitions.

Shoot-Through Prevention Function

The FAN7888 has shoot-through prevention circuitry monitoring the high- and low-side control inputs. It can be designed to prevent outputs of high and low side from turning on at same time, as shown Figure 27 and 28.

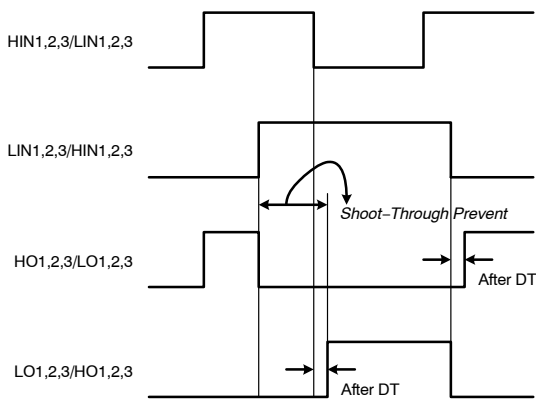

Figure 27. Waveforms for Shoot-Through Prevention

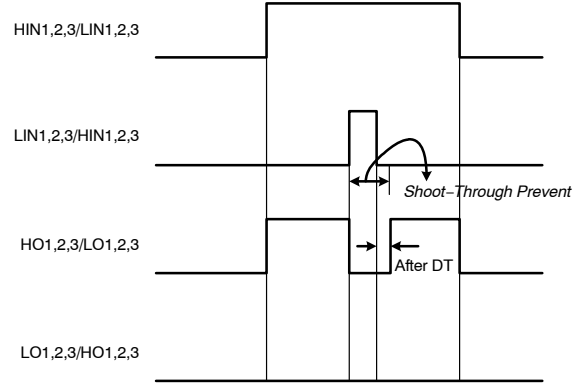

Figure 28. Waveforms for Shoot-Through Prevention

Operational Notes

The FAN7888 is a three half-bridge gate driver with internal, typical 270 ns dead-time for the three-phase brushless DC (BLDC) motor drive system, as shown in Figure 1.

Figure 29 shows a switching sequence of 120° electrical commutation for a three-phase BLDC motor drive system. The waveforms are idealized: they assumed that the generated back EMF waveforms are trapezoidal with flat tops of sufficient width to produce constant torque when the line currents are perfectly rectangular, 120° electrical degrees, with the switching sequence as shown in Figure 29. The operating waveforms of the wye-connection reveal that repeat every 60 electrical degrees, with each 60° segment being “commutated” to another phase, as shown in Figure 29.

FAN7888

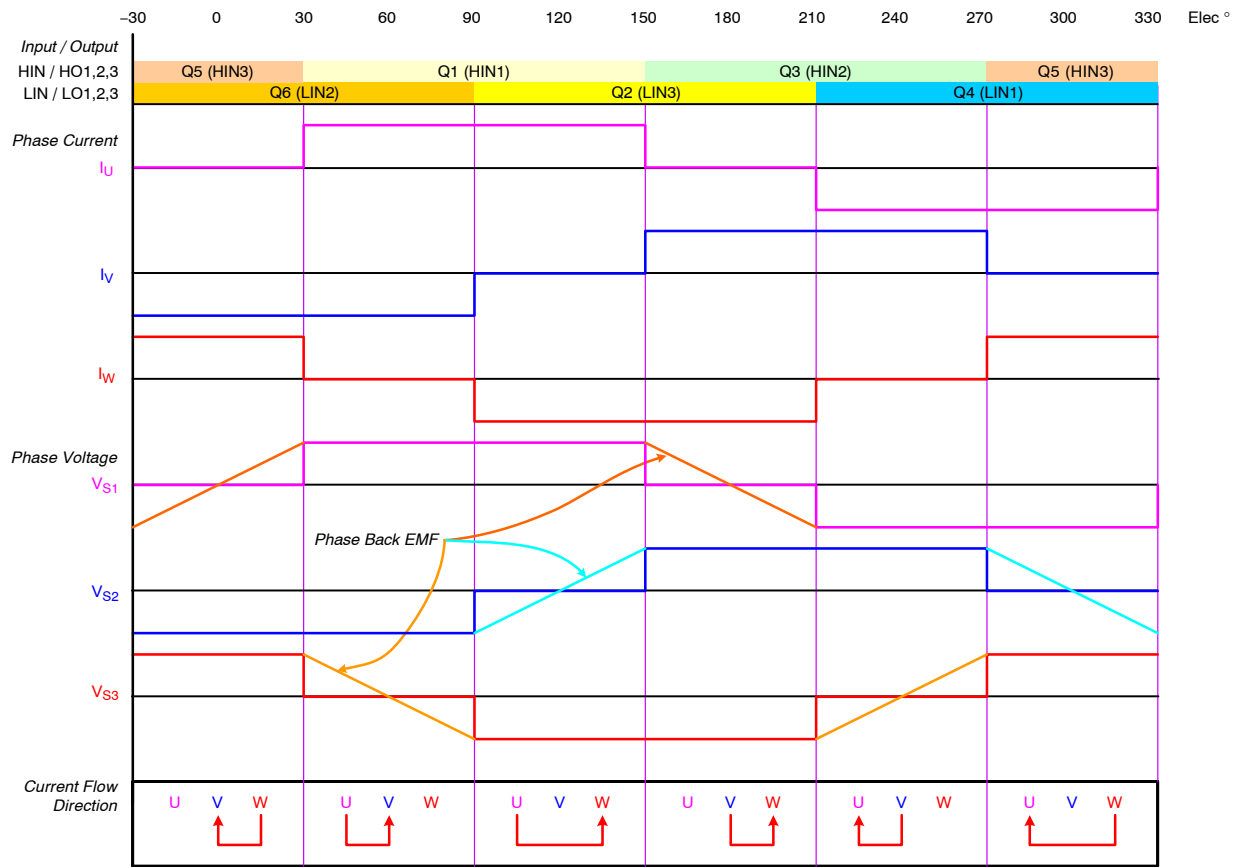

Figure 29. 120° Commutation Operation Waveforms for 3-Phase BLDC Motor Application

SWITCHING TIME DIAGRAM

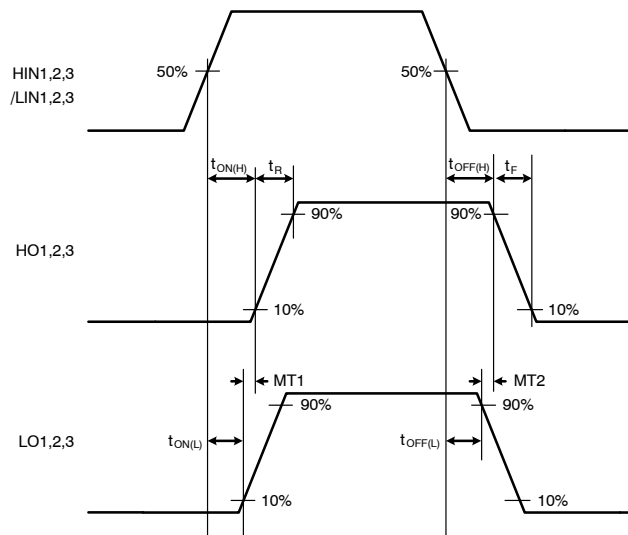

Figure 30. Switching Time Definition

FAN7888

ORDERING INFORMATION

Part Number	Package	Operating Temperature Range	Shipping [†]
FAN7888MX	SOIC-20, 300 mils (Pb-Free, Halide Free)	-40°C to +125°C	1000 / Tape & Reel

[†]For information on tape and reel specifications, including part orientation and tape sizes, please refer to our Tape and Reel Packaging Specifications Brochure, BRD8011/D.

MECHANICAL CASE OUTLINE

PACKAGE DIMENSIONS

ON Semiconductor®



SOIC-20, 300 mils
CASE 751BJ-01
ISSUE O

DATE 19 DEC 2008

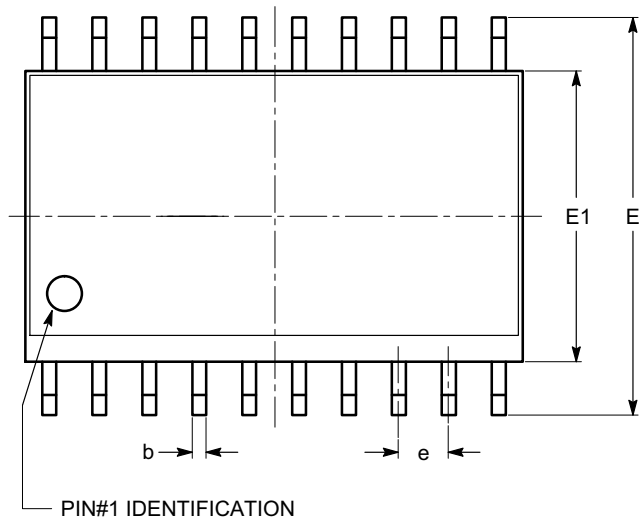

TOP VIEW

SYMBOL	MIN	NOM	MAX
A	2.36	2.49	2.64
A1	0.10		0.30
A2	2.05		2.55
b	0.31	0.41	0.51
c	0.20	0.27	0.33
D	12.60	12.80	13.00
E	10.01	10.30	10.64
E1	7.40	7.50	7.60
e	1.27 BSC		
h	0.25		0.75
L	0.40	0.81	1.27
θ	0°		8°
$\theta 1$	5°		15°

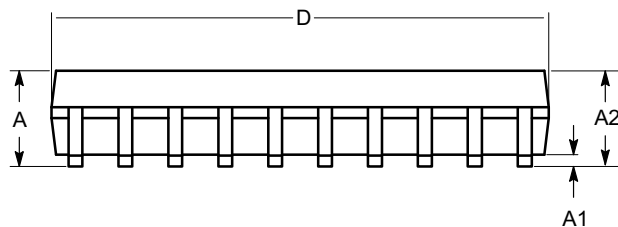

SIDE VIEW

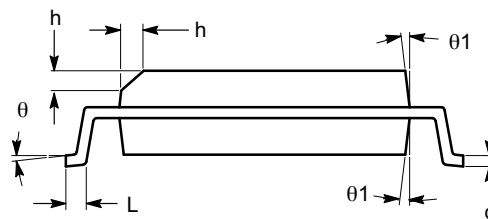

END VIEW

Notes:

- (1) All dimensions are in millimeters. Angles in degrees.
- (2) Complies with JEDEC MS-013.

DOCUMENT NUMBER:	98AON34287E	Electronic versions are uncontrolled except when accessed directly from the Document Repository. Printed versions are uncontrolled except when stamped "CONTROLLED COPY" in red.
DESCRIPTION:	SOIC-20, 300 MILS	PAGE 1 OF 1

ON Semiconductor and are trademarks of Semiconductor Components Industries, LLC dba ON Semiconductor or its subsidiaries in the United States and/or other countries. ON Semiconductor reserves the right to make changes without further notice to any products herein. ON Semiconductor makes no warranty, representation or guarantee regarding the suitability of its products for any particular purpose, nor does ON Semiconductor assume any liability arising out of the application or use of any product or circuit, and specifically disclaims any and all liability, including without limitation special, consequential or incidental damages. ON Semiconductor does not convey any license under its patent rights nor the rights of others.

onsemi, **Onsemi**, and other names, marks, and brands are registered and/or common law trademarks of Semiconductor Components Industries, LLC dba "**onsemi**" or its affiliates and/or subsidiaries in the United States and/or other countries. **onsemi** owns the rights to a number of patents, trademarks, copyrights, trade secrets, and other intellectual property. A listing of **onsemi**'s product/patent coverage may be accessed at www.onsemi.com/site/pdf/Patent-Marking.pdf. **onsemi** reserves the right to make changes at any time to any products or information herein, without notice. The information herein is provided "as-is" and **onsemi** makes no warranty, representation or guarantee regarding the accuracy of the information, product features, availability, functionality, or suitability of its products for any particular purpose, nor does **onsemi** assume any liability arising out of the application or use of any product or circuit, and specifically disclaims any and all liability, including without limitation special, consequential or incidental damages. Buyer is responsible for its products and applications using **onsemi** products, including compliance with all laws, regulations and safety requirements or standards, regardless of any support or applications information provided by **onsemi**. "Typical" parameters which may be provided in **onsemi** data sheets and/or specifications can and do vary in different applications and actual performance may vary over time. All operating parameters, including "Typicals" must be validated for each customer application by customer's technical experts. **onsemi** does not convey any license under any of its intellectual property rights nor the rights of others. **onsemi** products are not designed, intended, or authorized for use as a critical component in life support systems or any FDA Class 3 medical devices or medical devices with a same or similar classification in a foreign jurisdiction or any devices intended for implantation in the human body. Should Buyer purchase or use **onsemi** products for any such unintended or unauthorized application, Buyer shall indemnify and hold **onsemi** and its officers, employees, subsidiaries, affiliates, and distributors harmless against all claims, costs, damages, and expenses, and reasonable attorney fees arising out of, directly or indirectly, any claim of personal injury or death associated with such unintended or unauthorized use, even if such claim alleges that **onsemi** was negligent regarding the design or manufacture of the part. **onsemi** is an Equal Opportunity/Affirmative Action Employer. This literature is subject to all applicable copyright laws and is not for resale in any manner.

ADDITIONAL INFORMATION

TECHNICAL PUBLICATIONS:

Technical Library: www.onsemi.com/design/resources/technical-documentation
onsemi Website: www.onsemi.com

ONLINE SUPPORT: www.onsemi.com/support

For additional information, please contact your local Sales Representative at www.onsemi.com/support/sales