

MOSFET – N-Channel, POWERTRENCH[®], Ultra Thin, 1.5 V

20 V, 9.5 A, 23 mΩ

FDMA410NZT

Description

This Single N-Channel MOSFET has been designed using onsemi's advanced Power Trench process to optimize the $R_{DS(on)}$ @ $V_{GS} = 1.5\text{ V}$ on special MicroFET™ leadframe.

This design is similar to the FDMA410NZ, however it features our new advanced 0.55 mm max 2 x 2 MLP package technology.

Features

- 0.55 mm max package height MicroFET 2 x 2 mm Package
- Max $R_{DS(on)} = 23\text{ m}\Omega$ at $V_{GS} = 4.5\text{ V}$, $I_D = 9.5\text{ A}$
- Max $R_{DS(on)} = 29\text{ m}\Omega$ at $V_{GS} = 2.5\text{ V}$, $I_D = 8.0\text{ A}$
- Max $R_{DS(on)} = 36\text{ m}\Omega$ at $V_{GS} = 1.8\text{ V}$, $I_D = 4.0\text{ A}$
- Max $R_{DS(on)} = 60\text{ m}\Omega$ at $V_{GS} = 1.5\text{ V}$, $I_D = 2.0\text{ A}$
- HBM ESD protection level > 1.5 kV (Note 3)
- These Devices are Pb-Free, Halogen Free/BFR Free and are RoHS Compliant

Typical Applications

- Li-Ion Battery Pack
- Baseband Switch
- Load Switch
- DC-DC Conversion
- Mobile Device Switching

V_{DS}	$R_{DS(on)}$ MAX	I_D MAX
20 V	23 mΩ @ 4.5 V	9.5 A

Ultra Thin N-Channel

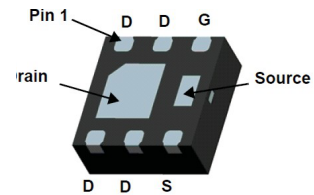
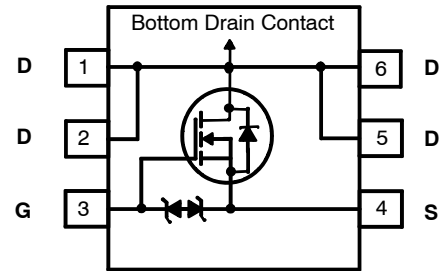

UDFN6 2.05x2.05 0.65P
(MicroFET)
CASE 517DT

MARKING DIAGRAM

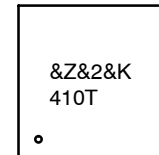

- &Z = Assembly Plant Code
- &2 = Numeric Date Code
- &K = Lot Code
- 410T = Specific Device Code

ORDERING INFORMATION

See detailed ordering and shipping information on page 2 of this data sheet.

FDMA410NZT

MAXIMUM RATINGS (T_A = 25°C, Unless otherwise specified)

Symbol	Parameter	Ratings	Unit
V _{DS}	Drain to Source Voltage	20	V
V _{GS}	Gate to Source Voltage	±8	V
I _D	–Continuous, T _A = 25°C (Note 1a)	9.5	A
	–Pulsed (Note 4)	63	
P _D	Power Dissipation, T _A = 25°C (Note 1a)	2.4	W
	Power Dissipation, T _A = 25°C (Note 1b)	0.9	
T _J , T _{STG}	Operating and Storage Junction Temperature Range	–55 to +150	°C

Stresses exceeding those listed in the Maximum Ratings table may damage the device. If any of these limits are exceeded, device functionality should not be assumed, damage may occur and reliability may be affected.

THERMAL CHARACTERISTICS

Symbol	Parameter	Ratings	Unit
R _{θJA}	Thermal Resistance, Junction to Ambient (Note 1a)	52	°C/W
R _{θJA}	Thermal Resistance, Junction to Ambient (Note 1b)	145	

PACKAGE MARKING AND ORDERING INFORMATION

Device Marking	Device	Package	Shipping (Qty / Packing) [†]	Pin 1 Orientation
410T	FDMA410NZT	MicroFET 2x2	3000 / Tape & Reel	Top left
410T	FDMA410NZT–F130	MicroFET 2x2	3000 / Tape & Reel	Top right

[†]For information on tape and reel specifications, including part orientation and tape sizes, please refer to our Tape and Reel Packaging Specifications Brochure, BRD8011/D.

ELECTRICAL CHARACTERISTICS (T_J = 25°C unless otherwise noted)

Symbol	Parameter	Test Conditions	Min	Typ	Max	Unit
--------	-----------	-----------------	-----	-----	-----	------

OFF CHARACTERISTICS

BV _{DSS}	Drain to Source Breakdown Voltage	I _D = 250 μA, V _{GS} = 0 V	20	–	–	V
$\frac{\Delta BV_{DSS}}{\Delta T_J}$	Breakdown Voltage Temperature Coefficient	I _D = 250 μA, referenced to 25°C	–	15	–	mV/°C
I _{DSS}	Zero Gate Voltage Drain Current	V _{DS} = 16 V, V _{GS} = 0 V	–	–	1	μA
I _{GSS}	Gate to Source Leakage Current	V _{GS} = ±8 V, V _{DS} = 0 V	–	–	±10	μA

ON CHARACTERISTICS

V _{GS(th)}	Gate to Source Threshold Voltage	V _{GS} = V _{DS} , I _D = 250 μA	0.4	0.8	1.0	V
$\frac{\Delta V_{GS(th)}}{\Delta T_J}$	Gate to Source Threshold Voltage Temperature Coefficient	I _D = 250 μA, referenced to 25°C	–	–3	–	mV/°C
R _{DS(on)}	Static Drain to Source On Resistance	V _{GS} = 4.5 V, I _D = 9.5 A	–	14	23	mΩ
		V _{GS} = 2.5 V, I _D = 8.0 A	–	18	29	
		V _{GS} = 1.8 V, I _D = 4.0 A	–	25	36	
		V _{GS} = 1.5 V, I _D = 2.0 A	–	35	60	
		V _{GS} = 4.5 V, I _D = 9.5 A, T _J = 125°C	–	21	32	
g _{FS}	Forward Transconductance	V _{DD} = 5 V, I _D = 9.5 A	–	36	–	S

FDMA410NZT

ELECTRICAL CHARACTERISTICS (T_J = 25°C unless otherwise noted)

Symbol	Parameter	Test Conditions	Min	Typ	Max	Unit
--------	-----------	-----------------	-----	-----	-----	------

DYNAMIC CHARACTERISTICS

C _{iss}	Input Capacitance	V _{DS} = 10 V, V _{GS} = 0 V, f = 1 MHz	–	935	1310	pF
C _{oss}	Output Capacitance		–	122	170	pF
C _{rss}	Reverse Transfer Capacitance		–	84	118	pF
R _g	Gate Resistance	f = 1 MHz	0.1	1.4	3.0	Ω

SWITCHING CHARACTERISTICS

t _{d(on)}	Turn-on Delay Time	V _{DD} = 10 V, I _D = 9.5 A, V _{GS} = 4.5 V, R _{GEN} = 6 Ω	–	8.5	17	ns
t _r	Rise Time		–	3.0	10	
t _{d(off)}	Turn-off Delay Time		–	27	44	
t _f	Fall Time		–	3.3	10	
Q _g	Total Gate Charge	V _{GS} = 4.5 V, V _{DD} = 10 V, I _D = 9.5 A	–	10	14	nC
Q _{gs}	Gate to Source Charge		–	1.2	–	
Q _{gd}	Gate to Drain "Miller" Charge		–	2.0	–	

DRAIN-SOURCE DIODE CHARACTERISTICS

I _S	Maximum Continuous Drain-Source Diode Forward Current	–	–	2.0	A	
V _{SD}	Source to Drain Diode Forward Voltage	V _{GS} = 0 V, I _S = 2 A (Note 2)	–	0.7	1.2	V
t _{rr}	Reverse Recovery Time	I _F = 9.5 A, di/dt = 100 A/μs	–	16	30	ns
Q _{rr}	Reverse Recovery Charge		–	4.5	10	

Product parametric performance is indicated in the Electrical Characteristics for the listed test conditions, unless otherwise noted. Product performance may not be indicated by the Electrical Characteristics if operated under different conditions.

NOTES:

- R_{θJA} is determined with the device mounted on a 1 in² pad 2 oz copper pad on a 1.5 × 1.5 in. board of FR-4 material. R_{θJA} is determined by the user's board design.

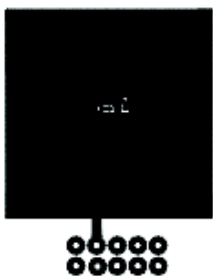

- a) 52°C/W when mounted on a 1 in² pad of 2 oz copper.

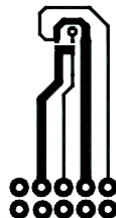

- b) 145°C/W when mounted on a minimum pad of 2 oz copper.

- Pulse Test: Pulse Width < 300 μs, Duty cycle < 2.0%.
- The diode connected between the gate and source serves only as protection against ESD. No gate overvoltage rating is implied.
- Pulsed I_d please refer to Figure 11 SOA curve for more details.

TYPICAL CHARACTERISTICS ($T_J = 25^\circ\text{C}$ unless otherwise noted)

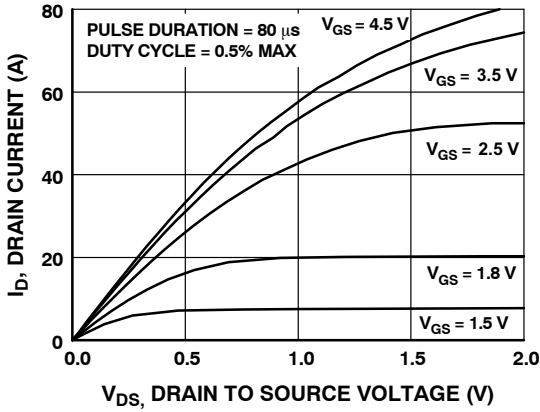

Figure 1. On Region Characteristics

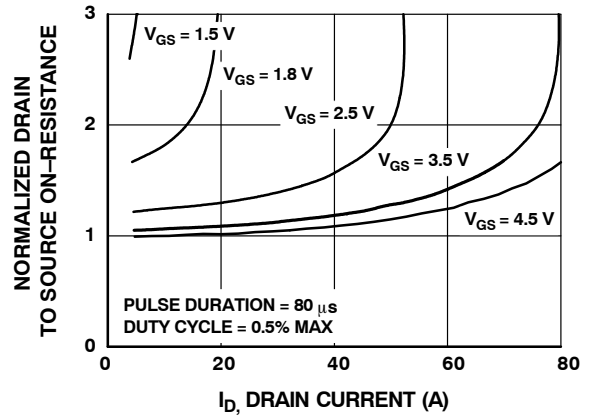

Figure 2. Normalized On-Resistance vs. Drain Current and Gate Voltage

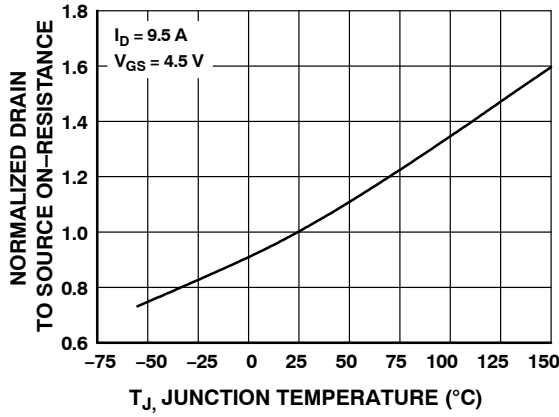

Figure 3. Normalized On Resistance vs. Junction Temperature

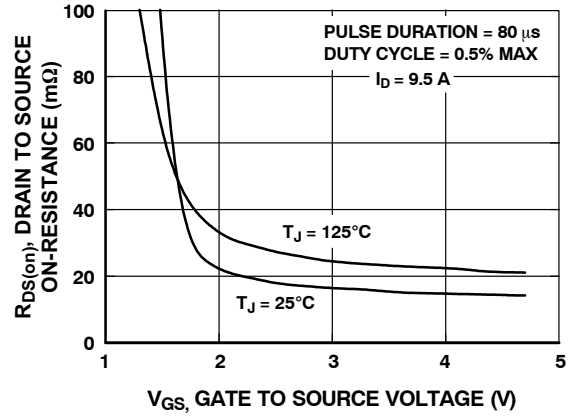

Figure 4. On-Resistance vs. Gate to Source Voltage

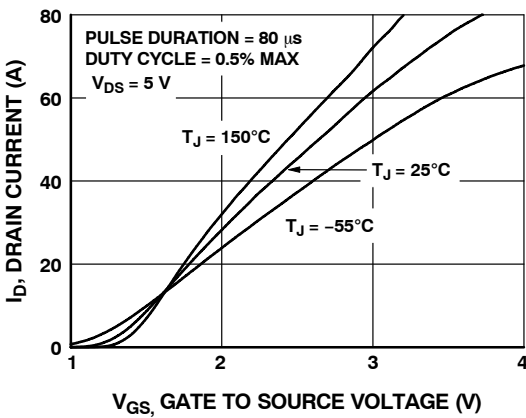

Figure 5. Transfer Characteristics

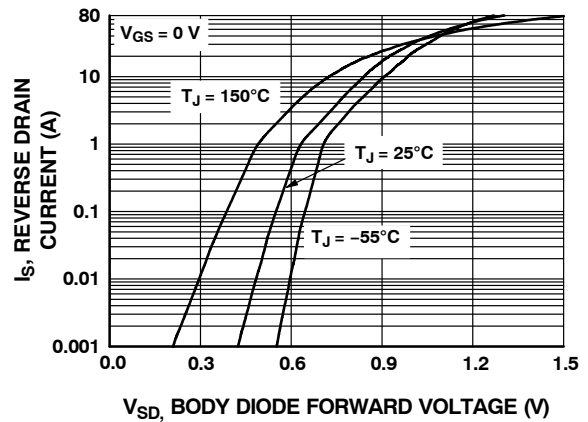

Figure 6. Source to Drain Diode Forward Voltage vs. Source Current

FDMA410NZT

TYPICAL CHARACTERISTICS (continued)

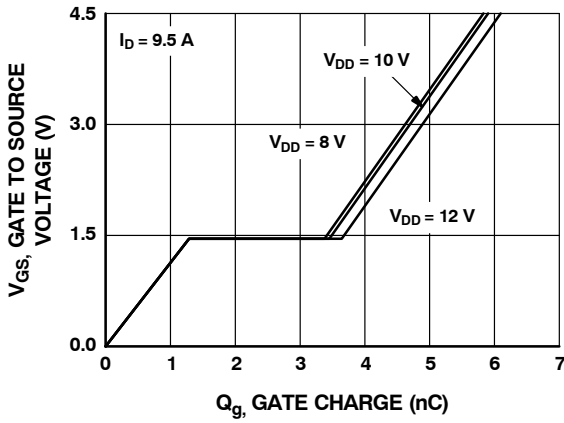

Figure 7. Gate Charge Characteristics

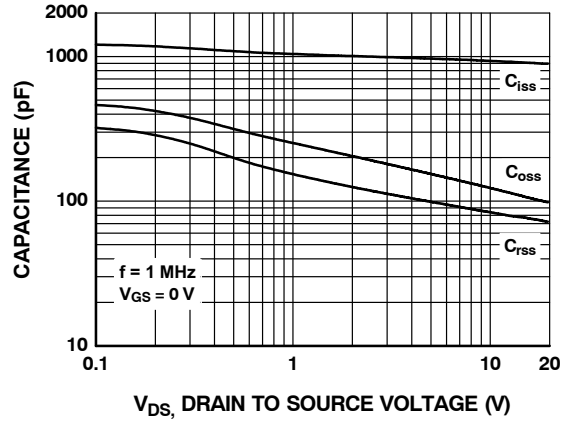

Figure 8. Capacitance vs. Drain to Source Voltage

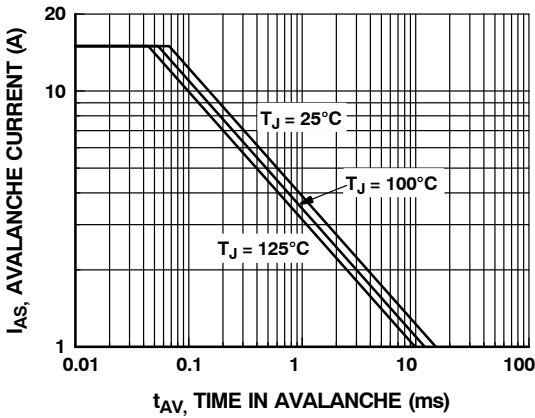

Figure 9. Unclamped Inductive Switching Capability

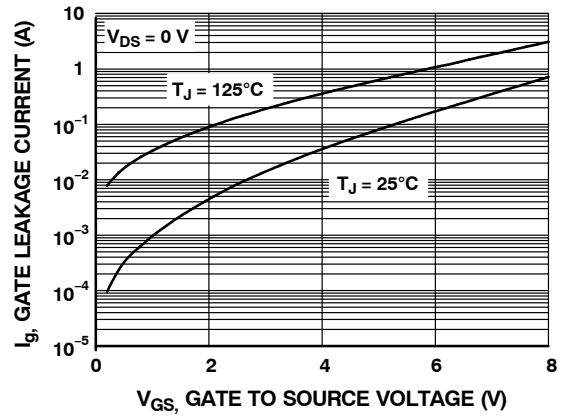

Figure 10. Gate Leakage Current vs. Gate to Source Voltage

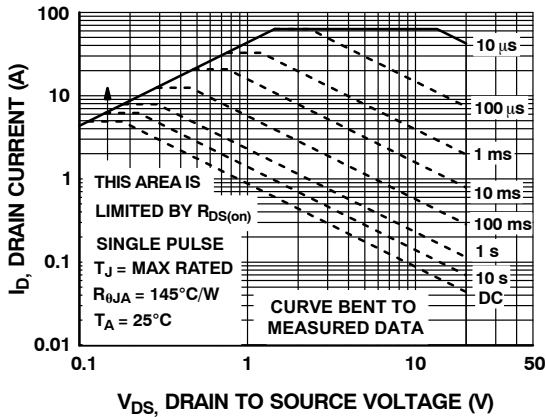

Figure 11. Forward Bias Safe Operating Area

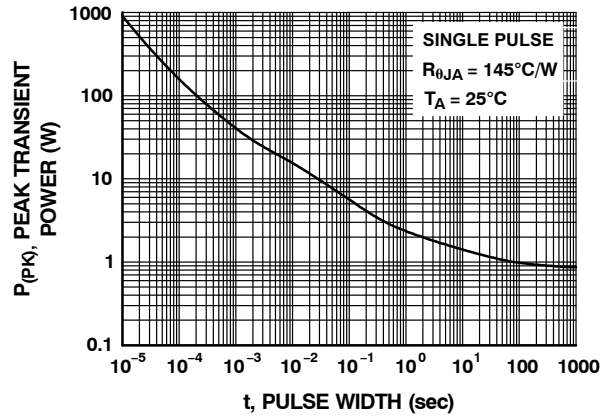

Figure 12. Single Pulse Maximum Power Dissipation

FDMA410NZT

TYPICAL CHARACTERISTICS (continued)

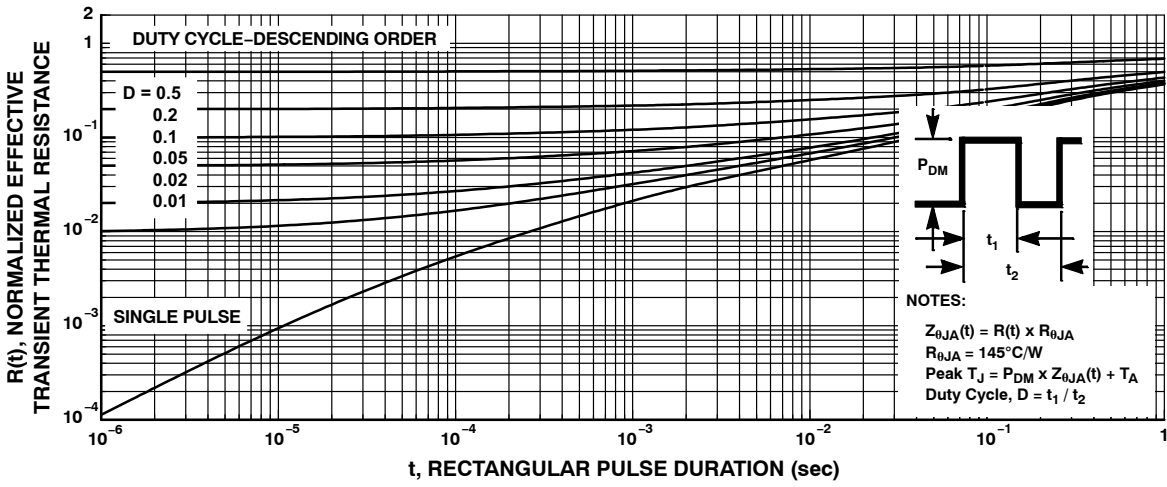

Figure 13. Junction-to-Case Transient Thermal Response Curve

MECHANICAL CASE OUTLINE
PACKAGE DIMENSIONS



UDFN6 2.05x2.05, 0.65P
CASE 517DT
ISSUE O

DATE 31 OCT 2016

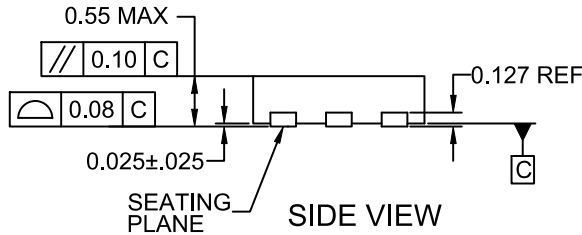
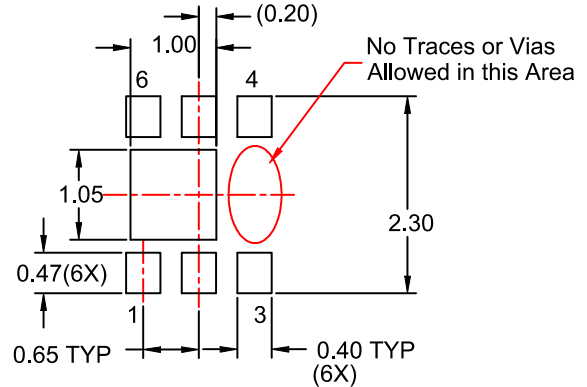
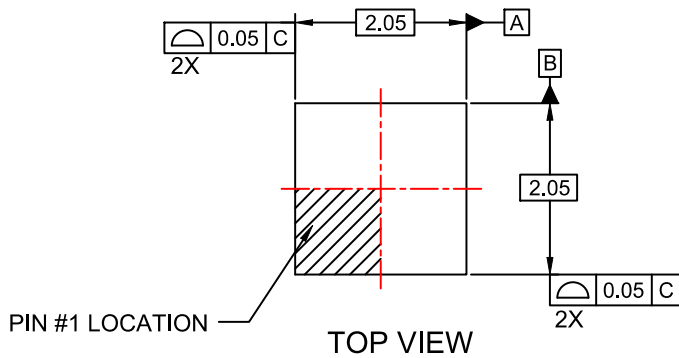

RECOMMENDED LAND PATTERN OPT 1

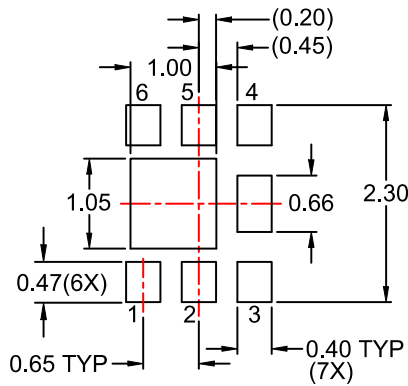
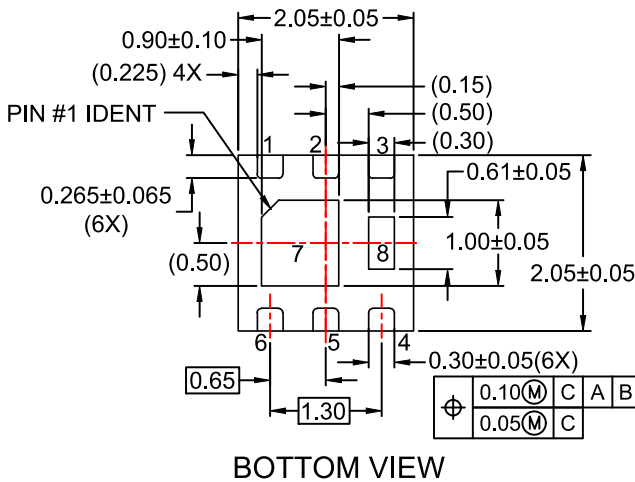

NOTES:

- A. PACKAGE DOES NOT CONFORM TO ANY JEDEC STANDARD.
- B. DIMENSIONS ARE IN MILLIMETERS.
- C. DIMENSIONS AND TOLERANCES PER ASME Y14.5M, 2009.
- D. LAND PATTERN RECOMMENDATION IS EXISTING INDUSTRY LAND PATTERN.

DOCUMENT NUMBER:	98AON13698G	Electronic versions are uncontrolled except when accessed directly from the Document Repository. Printed versions are uncontrolled except when stamped "CONTROLLED COPY" in red.
DESCRIPTION:	UDFN6 2.05x2.05, 0.65P	PAGE 1 OF 1

onsemi and onsemi are trademarks of Semiconductor Components Industries, LLC dba onsemi or its subsidiaries in the United States and/or other countries. onsemi reserves the right to make changes without further notice to any products herein. onsemi makes no warranty, representation or guarantee regarding the suitability of its products for any particular purpose, nor does onsemi assume any liability arising out of the application or use of any product or circuit, and specifically disclaims any and all liability, including without limitation special, consequential or incidental damages. onsemi does not convey any license under its patent rights nor the rights of others.

onsemi, **Onsemi**, and other names, marks, and brands are registered and/or common law trademarks of Semiconductor Components Industries, LLC dba "**onsemi**" or its affiliates and/or subsidiaries in the United States and/or other countries. **onsemi** owns the rights to a number of patents, trademarks, copyrights, trade secrets, and other intellectual property. A listing of **onsemi**'s product/patent coverage may be accessed at www.onsemi.com/site/pdf/Patent-Marking.pdf. **onsemi** reserves the right to make changes at any time to any products or information herein, without notice. The information herein is provided "as-is" and **onsemi** makes no warranty, representation or guarantee regarding the accuracy of the information, product features, availability, functionality, or suitability of its products for any particular purpose, nor does **onsemi** assume any liability arising out of the application or use of any product or circuit, and specifically disclaims any and all liability, including without limitation special, consequential or incidental damages. Buyer is responsible for its products and applications using **onsemi** products, including compliance with all laws, regulations and safety requirements or standards, regardless of any support or applications information provided by **onsemi**. "Typical" parameters which may be provided in **onsemi** data sheets and/or specifications can and do vary in different applications and actual performance may vary over time. All operating parameters, including "Typicals" must be validated for each customer application by customer's technical experts. **onsemi** does not convey any license under any of its intellectual property rights nor the rights of others. **onsemi** products are not designed, intended, or authorized for use as a critical component in life support systems or any FDA Class 3 medical devices or medical devices with a same or similar classification in a foreign jurisdiction or any devices intended for implantation in the human body. Should Buyer purchase or use **onsemi** products for any such unintended or unauthorized application, Buyer shall indemnify and hold **onsemi** and its officers, employees, subsidiaries, affiliates, and distributors harmless against all claims, costs, damages, and expenses, and reasonable attorney fees arising out of, directly or indirectly, any claim of personal injury or death associated with such unintended or unauthorized use, even if such claim alleges that **onsemi** was negligent regarding the design or manufacture of the part. **onsemi** is an Equal Opportunity/Affirmative Action Employer. This literature is subject to all applicable copyright laws and is not for resale in any manner.

PUBLICATION ORDERING INFORMATION

LITERATURE FULFILLMENT:

Email Requests to: orderlit@onsemi.com

onsemi Website: www.onsemi.com

TECHNICAL SUPPORT

North American Technical Support:

Voice Mail: 1 800-282-9855 Toll Free USA/Canada

Phone: 011 421 33 790 2910

Europe, Middle East and Africa Technical Support:

Phone: 00421 33 790 2910

For additional information, please contact your local Sales Representative