

3-STATE Octal D-Type Flip-Flop

MM74HC374

General Description

The MM74HC374 high speed Octal D-Type Flip-Flops utilize advanced silicon-gate CMOS technology. They possess the high noise immunity and low power consumption of standard CMOS integrated circuits, as well as the ability to drive 15 LS-TTL loads. Due to the large output drive capability and the 3-STATE feature, these devices are ideally suited for interfacing with bus lines in a bus organized system.

These devices are positive edge triggered flip-flops. Data at the D inputs, meeting the setup and hold time requirements, are transferred to the Q outputs on positive going transitions of the CLOCK (CK) input. When a high logic level is applied to the OUTPUT CONTROL (OC) input, all outputs go to a high impedance state, regardless of what signals are present at the other inputs and the state of the storage elements.

The 74HC logic family is speed, function, and pinout compatible with the standard 74LS logic family. All inputs are protected from damage due to static discharge by internal diode clamps to VCC and ground.

Features

- Typical Propagation Delay: 20 ns
- Wide Operating Voltage Range: 2-6 V
- Low Input Current: 1 μ A Maximum
- Low Quiescent Current: 160 μ A Maximum
- Compatible with Bus-oriented Systems
- Output Drive Capability: 15 LS-TTL Loads
- This is a Pb-Free Device

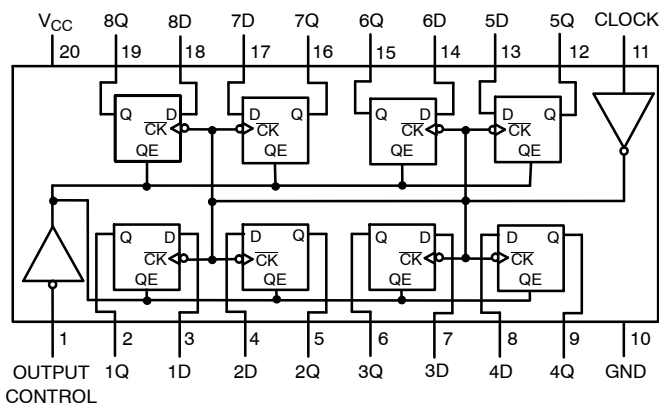

Pin Assignments for SOIC and TSSOP (Top View)

Figure 1. Connection Diagram

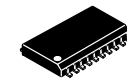

SOIC-20 WB
CASE 751D-05

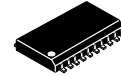

SOIC-20, 300 mils
CASE 751BJ-01

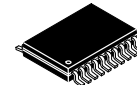

TSSOP-20 WB
CASE 948E

MARKING DIAGRAMS

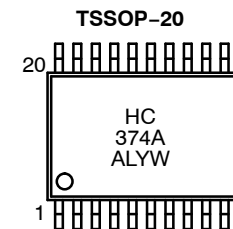
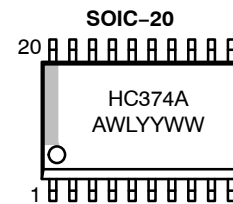

HC374A = Specific Device Code
A = Assembly Location
WL, L = Wafer Lot Number
Y = Year
WW, YW = Work Week

ORDERING INFORMATION

See detailed ordering and shipping information on page 5 of this data sheet.

MM74HC374

TRUTH TABLE

Output Control	Clock	Data	Output
L	↑	H	H
L	↑	L	L
L	L	X	Q ₀
H	X	X	Z

NOTES:

- H = HIGH Level
- L = LOW Level
- X = Don't Care
- ↑ = Transition from LOW-to-HIGH
- Z = High Impedance State
- Q₀ = The level of the output before steady state input conditions were established.

ABSOLUTE MAXIMUM RATINGS (Note 1)

Symbol	Rating	Value	Unit	
V _{CC}	Supply Voltage	-0.5 to +7.0 V	V	
V _{IN}	DC Input Voltage	-0.5 to V _{CC} +0.5 V	V	
V _{OUT}	DC Output Voltage	-0.5 to V _{CC} +0.5 V	V	
I _{IK} , I _{OK}	Clamp Diode Current	±20	mA	
I _{OUT}	DC Output Current, per pin	±35	mA	
I _{CC}	DC V _{CC} or GND Current, per pin	±70	mA	
T _{STG}	Storage Temperature Range	-65 to +150	°C	
P _D	Power Dissipation	Note 2	600	mW
		S. O. Package only	500	mW
T _L	Lead Temperature (Soldering 10 seconds)	260	°C	

Stresses exceeding those listed in the Maximum Ratings table may damage the device. If any of these limits are exceeded, device functionality should not be assumed, damage may occur and reliability may be affected.

1. Unless otherwise specified all voltages are referenced to ground.
2. Power Dissipation temperature derating – plastic “N” package: 12 mW/°C from 65°C to 85°C.

RECOMMENDED OPERATING CONDITIONS

Symbol	Parameter	Min	Max	Unit	
V _{CC}	Supply Voltage	2	6	V	
V _{IN} , V _{OUT}	DC Input or Output Voltage	0	V _{CC}	V	
T _A	Operating Temperature Range	-55	+125	°C	
t _r , t _f	Input Rise or Fall Times	V _{CC} = 2.0 V	-	1000	ns
		V _{CC} = 4.5 V	-	500	ns
		V _{CC} = 6.0 V	-	400	ns

Functional operation above the stresses listed in the Recommended Operating Ranges is not implied. Extended exposure to stresses beyond the Recommended Operating Ranges limits may affect device reliability.

MM74HC374

DC ELECTRICAL CHARACTERISTICS (Note 3)

Symbol	Parameter	Conditions	V _{CC}	T _A = 25°C		T _A = -40 to 85°C	T _A = -55 to 125°C	Unit
				Typ	Guaranteed Limits			
V _{IH}	Minimum HIGH Level Input Voltage		2.0 V		1.5	1.5	1.5	V
			4.5 V		3.15	3.15	3.15	V
			6.0 V		4.2	4.2	4.2	V
V _{IL}	Maximum LOW Level Input Voltage		2.0 V		0.5	0.5	0.5	V
			4.5 V		1.35	1.35	1.35	V
			6.0 V		1.8	1.8	1.8	V
V _{OH}	Minimum HIGH Level Output Voltage	V _{IN} = V _{IH} or V _{IL} I _{OUT} ≤ 20 μA	2.0 V	2.0	1.9	1.9	1.9	V
			4.5 V	4.5	4.4	4.4	4.4	V
			6.0 V	6.0	5.9	5.9	5.9	V
		V _{IN} = V _{IH} or V _{IL} I _{OUT} ≤ 6.0 mA I _{OUT} ≤ 7.8 mA	4.5 V	4.2	3.98	3.84	3.7	V
			6.0 V	5.7	5.48	5.34	5.2	V
V _{OL}	Maximum LOW Level Output Voltage	V _{IN} = V _{IH} or V _{IL} I _{OUT} ≤ 20 μA	2.0 V	0	0.1	0.1	0.1	V
			4.5 V	0	0.1	0.1	0.1	V
			6.0 V	0	0.1	0.1	0.1	V
		V _{IN} = V _{IH} or V _{IL} I _{OUT} ≤ 6.0 mA I _{OUT} ≤ 7.8 mA	4.5 V	0.2	0.26	0.33	0.4	V
			6.0 V	0.2	0.26	0.33	0.4	V
I _{IN}	Maximum Input Current	V _{IN} = V _{CC} or GND	6.0 V		±0.1	±1.0	±1.0	μA
I _{OZ}	Maximum 3-STATE Output Leakage Current	V _{IN} = V _{IH} , OC = V _{IH} V _{OUT} = V _{CC} or GND	6.0 V		±0.5	±5	±10	μA
I _{CC}	Maximum Quiescent Supply Current	V _{IN} = V _{CC} or GND I _{OUT} = 0 μA	6.0 V		8.0	80	160	μA

Product parametric performance is indicated in the Electrical Characteristics for the listed test conditions, unless otherwise noted. Product performance may not be indicated by the Electrical Characteristics if operated under different conditions.

3. For a power supply of 5 V ±10% the worst case output voltages (V_{OH}, and V_{OL}) occur for HC at 4.5 V. Thus the 4.5 V values should be used when designing with this supply. Worst case V_{IH} and V_{IL} occur at V_{CC} = 5.5 V and 4.5 V respectively. (The V_{IH} value at 5.5 V is 3.85 V.) The worst case leakage current (I_{IN}, I_{CC}, and I_{OZ}) occur for CMOS at the higher voltage and so the 6.0 V values should be used.

AC ELECTRICAL CHARACTERISTICS

(V_{CC} = 5 V, T_A = 25°C, t_r = t_f = 6 ns)

Symbol	Parameter	Conditions	Typ	Guaranteed Limit	Unit
f _{MAX}	Maximum Operating Frequency		50	35	MHz
t _{PHL} , t _{PLH}	Maximum Propagation Delay Clock to Q	C _L = 45 pF	20	32	ns
t _{PZH} , t _{PZL}	Maximum Output Enable Time	R _L = 1 kΩ, C _L = 45 pF	19	28	ns
t _{PHZ} , t _{PLZ}	Maximum Output Disable Time	R _L = 1 kΩ, C _L = 5 pF	17	25	ns
t _S	Minimum Setup Time		-	20	ns
t _H	Minimum Hold Time		-	5	ns
t _W	Minimum Pulse Width		9	16	ns

Product parametric performance is indicated in the Electrical Characteristics for the listed test conditions, unless otherwise noted. Product performance may not be indicated by the Electrical Characteristics if operated under different conditions.

MM74HC374

AC ELECTRICAL CHARACTERISTICS

(V_{CC} = 2.0–6.0 V, C_L = 50 pF, t_r = t_f = 6 ns, unless otherwise specified)

Symbol	Parameter	Conditions	V _{CC}	T _A = 25°C		T _A = -40 to 85°C	T _A = -55 to 125°C	Unit	
				Typ	Guaranteed Limits				
f _{MAX}	Maximum Operating Frequency	C _L = 50 pF	2.0 V		6	5	4	MHz	
			4.5 V		30	24	20	MHz	
			6.0 V		35	28	23	MHz	
t _{PHL} , t _{PLH}	Maximum Propagation Delay, Clock to Q	C _L = 50 pF	2.0 V	68	180	225	270	ns	
			2.0 V	110	230	288	345	ns	
		C _L = 150 pF	4.5 V	22	36	45	48	ns	
			4.5 V	30	46	57	69	ns	
		C _L = 50 pF	6.0 V	20	31	39	46	ns	
			6.0 V	28	40	50	60	ns	
t _{PZH} , t _{PZL}	Maximum Output Enable Time	R _L = 1 kΩ	C _L = 50 pF	2.0 V	50	150	189	225	ns
				2.0 V	80	200	250	300	ns
				C _L = 150 pF	4.5 V	21	30	37	45
		4.5 V	30		40	50	60	ns	
		C _L = 50 pF	6.0 V		19	26	31	39	ns
			6.0 V	26	35	44	53	ns	
t _{PHZ} , t _{PLZ}	Maximum Output Disable Time	R _L = 1 kΩ	C _L = 50 pF	2.0 V	50	150	189	225	ns
				4.5 V	21	30	37	45	ns
				6.0 V	19	26	31	39	ns
t _S	Minimum Setup Time		2.0 V		50	60	75	ns	
			4.5 V		9	13	15	ns	
			6.0 V		9	11	13	ns	
t _H	Minimum Hold Time		2.0 V		5	30	5	ns	
			4.5 V		5	5	5	ns	
			6.0 V		5	5	5	ns	
t _W	Minimum Pulse Width		2.0 V	30	80	100	120	ns	
			4.5 V	9	16	20	24	ns	
			6.0 V	8	14	18	20	ns	
t _{THL} , t _{TLH}	Maximum Output Rise and Fall Time	C _L = 50 pF	2.0 V	25	60	75	90	ns	
			4.5 V	7	12	15	18	ns	
			6.0 V	6	10	13	15	ns	
t _r , t _f	Maximum Input Rise and Fall Time, Clock		2.0 V		1000	1000	1000	ns	
			4.5 V		500	500	500	ns	
			6.0 V		400	400	400	ns	
C _{PD}	Power Dissipation Capacitance (Note 4)	(per flip-flop) OC = V _{CC} OC = GND		30				pF	
				50				pF	
C _{IN}	Maximum Input Capacitance			5	10	10	10	pF	

Product parametric performance is indicated in the Electrical Characteristics for the listed test conditions, unless otherwise noted. Product performance may not be indicated by the Electrical Characteristics if operated under different conditions.

4. C_{PD} determines the no load dynamic power consumption, P_D = C_{PD} V_{CC}²f + I_{CC} V_{CC}, and the no load dynamic current consumption, I_S = C_{PD} V_{CC} f + I_{CC}.

MM74HC374

ORDERING INFORMATION

Device	Package	Shipping†
MM74HC374WM	SOIC-20 WB (Pb-Free and Halide Free)	38 Units / Tube
MM74HC374WMX	SOIC-20, 300 mils (Pb-Free and Halide Free)	1000 / Tape & Reel
MM74HC374MTC	TSSOP-20 WB (Pb-Free)	75 Units / Tube
MM74HC374MTCX		2500 / Tape & Reel

†For information on tape and reel specifications, including part orientation and tape sizes, please refer to our Tape and Reel Packaging Specifications Brochure, [BRD8011/D](#).

MECHANICAL CASE OUTLINE

PACKAGE DIMENSIONS

ON Semiconductor®



SOIC-20, 300 mils
CASE 751BJ-01
ISSUE O

DATE 19 DEC 2008

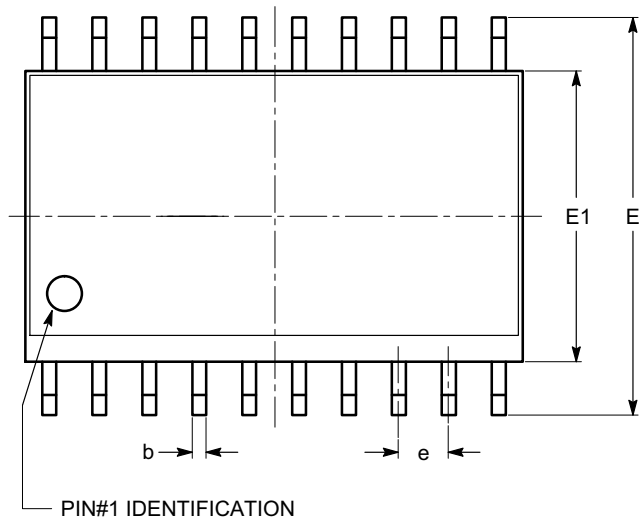

TOP VIEW

SYMBOL	MIN	NOM	MAX
A	2.36	2.49	2.64
A1	0.10		0.30
A2	2.05		2.55
b	0.31	0.41	0.51
c	0.20	0.27	0.33
D	12.60	12.80	13.00
E	10.01	10.30	10.64
E1	7.40	7.50	7.60
e	1.27 BSC		
h	0.25		0.75
L	0.40	0.81	1.27
θ	0°		8°
$\theta 1$	5°		15°

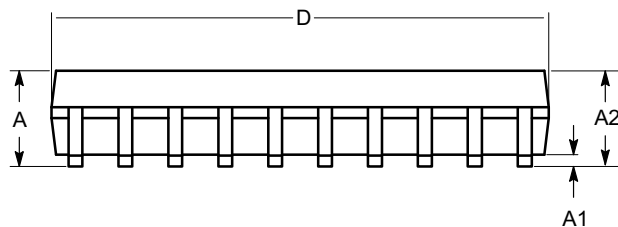

SIDE VIEW

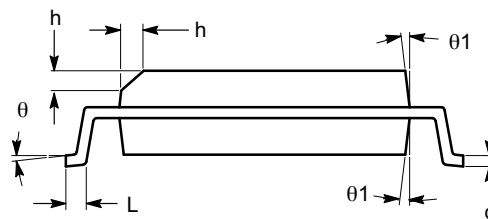

END VIEW

Notes:

- (1) All dimensions are in millimeters. Angles in degrees.
- (2) Complies with JEDEC MS-013.

DOCUMENT NUMBER:	98AON34287E	Electronic versions are uncontrolled except when accessed directly from the Document Repository. Printed versions are uncontrolled except when stamped "CONTROLLED COPY" in red.
DESCRIPTION:	SOIC-20, 300 MILS	PAGE 1 OF 1

ON Semiconductor and are trademarks of Semiconductor Components Industries, LLC dba ON Semiconductor or its subsidiaries in the United States and/or other countries. ON Semiconductor reserves the right to make changes without further notice to any products herein. ON Semiconductor makes no warranty, representation or guarantee regarding the suitability of its products for any particular purpose, nor does ON Semiconductor assume any liability arising out of the application or use of any product or circuit, and specifically disclaims any and all liability, including without limitation special, consequential or incidental damages. ON Semiconductor does not convey any license under its patent rights nor the rights of others.

MECHANICAL CASE OUTLINE PACKAGE DIMENSIONS

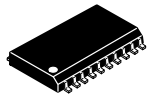

SCALE 1:1

SOIC-20 WB
CASE 751D-05
ISSUE H

DATE 22 APR 2015



NOTES:

1. DIMENSIONS ARE IN MILLIMETERS.
2. INTERPRET DIMENSIONS AND TOLERANCES PER ASME Y14.5M, 1994.
3. DIMENSIONS D AND E DO NOT INCLUDE MOLD PROTRUSION.
4. MAXIMUM MOLD PROTRUSION 0.15 PER SIDE.
5. DIMENSION B DOES NOT INCLUDE DAMBAR PROTRUSION. ALLOWABLE PROTRUSION SHALL BE 0.13 TOTAL IN EXCESS OF B DIMENSION AT MAXIMUM MATERIAL CONDITION.

DIM	MILLIMETERS	
	MIN	MAX
A	2.35	2.65
A1	0.10	0.25
b	0.35	0.49
c	0.23	0.32
D	12.65	12.95
E	7.40	7.60
e	1.27 BSC	
H	10.05	10.55
h	0.25	0.75
L	0.50	0.90
θ	0°	7°

RECOMMENDED
SOLDERING FOOTPRINT*



DIMENSIONS: MILLIMETERS

*For additional information on our Pb-Free strategy and soldering details, please download the ON Semiconductor Soldering and Mounting Techniques Reference Manual, SOLDERRM/D.

GENERIC
MARKING DIAGRAM*

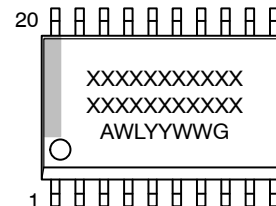

- XXXXXX = Specific Device Code
- A = Assembly Location
- WL = Wafer Lot
- YY = Year
- WW = Work Week
- G = Pb-Free Package

*This information is generic. Please refer to device data sheet for actual part marking. Pb-Free indicator, "G" or microdot "▪", may or may not be present. Some products may not follow the Generic Marking.

DOCUMENT NUMBER:	98ASB42343B	Electronic versions are uncontrolled except when accessed directly from the Document Repository. Printed versions are uncontrolled except when stamped "CONTROLLED COPY" in red.
DESCRIPTION:	SOIC-20 WB	PAGE 1 OF 1

onsemi and ONSEMI are trademarks of Semiconductor Components Industries, LLC dba onsemi or its subsidiaries in the United States and/or other countries. onsemi reserves the right to make changes without further notice to any products herein. onsemi makes no warranty, representation or guarantee regarding the suitability of its products for any particular purpose, nor does onsemi assume any liability arising out of the application or use of any product or circuit, and specifically disclaims any and all liability, including without limitation special, consequential or incidental damages. onsemi does not convey any license under its patent rights nor the rights of others.

MECHANICAL CASE OUTLINE PACKAGE DIMENSIONS

ON Semiconductor®



TSSOP-20 WB
CASE 948E
ISSUE D

DATE 17 FEB 2016

SCALE 2:1



NOTES:

1. DIMENSIONING AND TOLERANCING PER ANSI Y14.5M, 1982.
2. CONTROLLING DIMENSION: MILLIMETER.
3. DIMENSION A DOES NOT INCLUDE MOLD FLASH, PROTRUSIONS OR GATE BURRS. MOLD FLASH OR GATE BURRS SHALL NOT EXCEED 0.15 (0.006) PER SIDE.
4. DIMENSION B DOES NOT INCLUDE INTERLEAD FLASH OR PROTRUSION. INTERLEAD FLASH OR PROTRUSION SHALL NOT EXCEED 0.25 (0.010) PER SIDE.
5. DIMENSION K DOES NOT INCLUDE DAMBAR PROTRUSION. ALLOWABLE DAMBAR PROTRUSION SHALL BE 0.08 (0.003) TOTAL IN EXCESS OF THE K DIMENSION AT MAXIMUM MATERIAL CONDITION.
6. TERMINAL NUMBERS ARE SHOWN FOR REFERENCE ONLY.
7. DIMENSION A AND B ARE TO BE DETERMINED AT DATUM PLANE -W-.

DIM	MILLIMETERS		INCHES	
	MIN	MAX	MIN	MAX
A	6.40	6.60	0.252	0.260
B	4.30	4.50	0.169	0.177
C	---	1.20	---	0.047
D	0.05	0.15	0.002	0.006
F	0.50	0.75	0.020	0.030
G	0.65 BSC		0.026 BSC	
H	0.27	0.37	0.011	0.015
J	0.09	0.20	0.004	0.008
J1	0.09	0.16	0.004	0.006
K	0.19	0.30	0.007	0.012
K1	0.19	0.25	0.007	0.010
L	6.40 BSC		0.252 BSC	
M	0°	8°	0°	8°

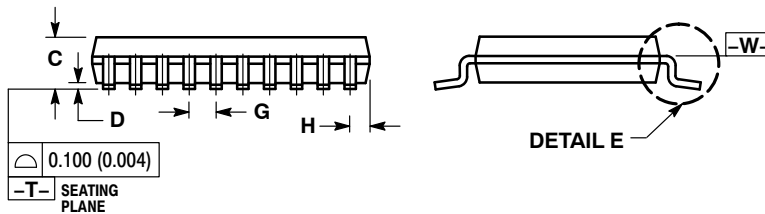

SOLDERING FOOTPRINT



GENERIC MARKING DIAGRAM*



- A = Assembly Location
- L = Wafer Lot
- Y = Year
- W = Work Week
- = Pb-Free Package

(Note: Microdot may be in either location)

*This information is generic. Please refer to device data sheet for actual part marking. Pb-Free indicator, "G" or microdot "▪", may or may not be present.

DOCUMENT NUMBER:	98ASH70169A	Electronic versions are uncontrolled except when accessed directly from the Document Repository. Printed versions are uncontrolled except when stamped "CONTROLLED COPY" in red.
DESCRIPTION:	TSSOP-20 WB	PAGE 1 OF 1

ON Semiconductor and ON are trademarks of Semiconductor Components Industries, LLC dba ON Semiconductor or its subsidiaries in the United States and/or other countries. ON Semiconductor reserves the right to make changes without further notice to any products herein. ON Semiconductor makes no warranty, representation or guarantee regarding the suitability of its products for any particular purpose, nor does ON Semiconductor assume any liability arising out of the application or use of any product or circuit, and specifically disclaims any and all liability, including without limitation special, consequential or incidental damages. ON Semiconductor does not convey any license under its patent rights nor the rights of others.

onsemi, **Onsemi**, and other names, marks, and brands are registered and/or common law trademarks of Semiconductor Components Industries, LLC dba "**onsemi**" or its affiliates and/or subsidiaries in the United States and/or other countries. **onsemi** owns the rights to a number of patents, trademarks, copyrights, trade secrets, and other intellectual property. A listing of **onsemi**'s product/patent coverage may be accessed at www.onsemi.com/site/pdf/Patent-Marking.pdf. **onsemi** reserves the right to make changes at any time to any products or information herein, without notice. The information herein is provided "as-is" and **onsemi** makes no warranty, representation or guarantee regarding the accuracy of the information, product features, availability, functionality, or suitability of its products for any particular purpose, nor does **onsemi** assume any liability arising out of the application or use of any product or circuit, and specifically disclaims any and all liability, including without limitation special, consequential or incidental damages. Buyer is responsible for its products and applications using **onsemi** products, including compliance with all laws, regulations and safety requirements or standards, regardless of any support or applications information provided by **onsemi**. "Typical" parameters which may be provided in **onsemi** data sheets and/or specifications can and do vary in different applications and actual performance may vary over time. All operating parameters, including "Typicals" must be validated for each customer application by customer's technical experts. **onsemi** does not convey any license under any of its intellectual property rights nor the rights of others. **onsemi** products are not designed, intended, or authorized for use as a critical component in life support systems or any FDA Class 3 medical devices or medical devices with a same or similar classification in a foreign jurisdiction or any devices intended for implantation in the human body. Should Buyer purchase or use **onsemi** products for any such unintended or unauthorized application, Buyer shall indemnify and hold **onsemi** and its officers, employees, subsidiaries, affiliates, and distributors harmless against all claims, costs, damages, and expenses, and reasonable attorney fees arising out of, directly or indirectly, any claim of personal injury or death associated with such unintended or unauthorized use, even if such claim alleges that **onsemi** was negligent regarding the design or manufacture of the part. **onsemi** is an Equal Opportunity/Affirmative Action Employer. This literature is subject to all applicable copyright laws and is not for resale in any manner.

PUBLICATION ORDERING INFORMATION

LITERATURE FULFILLMENT:

Email Requests to: orderlit@onsemi.com

onsemi Website: www.onsemi.com

TECHNICAL SUPPORT

North American Technical Support:

Voice Mail: 1 800-282-9855 Toll Free USA/Canada

Phone: 011 421 33 790 2910

Europe, Middle East and Africa Technical Support:

Phone: 00421 33 790 2910

For additional information, please contact your local Sales Representative