

# 300 mA, Ultra-Low Quiescent Current, $I_Q$ 12 $\mu$ A, Ultra-Low Noise, LDO Voltage Regulator

## NCP703

Noise sensitive RF applications such as Power Amplifiers in satellite radios, infotainment equipment, and precision instrumentation require very clean power supplies. The NCP703 is 300 mA LDO that provides the engineer with a very stable, accurate voltage with ultra low noise and very high Power Supply Rejection Ratio (PSRR) suitable for RF applications. The device doesn't require any additional noise bypass capacitor to achieve ultra-low noise performance. In order to optimize performance for battery operated portable applications, the NCP703 employs dynamic  $I_Q$  management for ultra-low quiescent current consumption at light-load conditions and great dynamic performance.

### Features

- Operating Input Voltage Range: 2.0 V to 5.5 V
- Available in Fixed Voltage Options: 0.8 to 3.5 V  
Contact Factory for Other Voltage Options
- Ultra-Low Quiescent Current of Typ. 12  $\mu$ A
- Ultra-Low Noise: 13  $\mu$ V<sub>RMS</sub> from 100 Hz to 100 kHz
- Very Low Dropout: 180 mV Typical at 300 mA
- $\pm 2\%$  Accuracy Over Load/Line/Temperature
- High PSRR: 68 dB at 1 kHz
- Internal Soft-Start to Limit the Turn-On Inrush Current
- Thermal Shutdown and Current Limit Protections
- Stable with a 1  $\mu$ F Ceramic Output Capacitor
- Available in TSOP-5 and XDFN 1.5 x 1.5 mm Package
- Active Output Discharge for Fast Turn-Off
- These are Pb-Free Devices

### Typical Applications

- PDAs, Mobile Phones, GPS, Smartphones
- Wireless Handsets, Wireless LAN, Bluetooth, Zigbee
- Portable Medical Equipment
- Other Battery Powered Applications

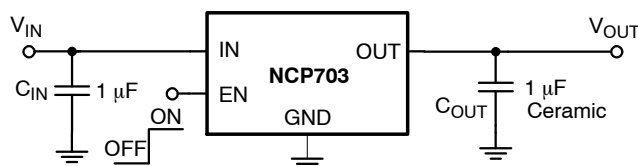
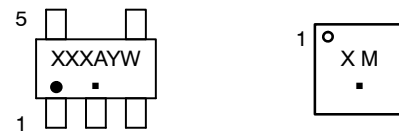

Figure 1. Typical Application Schematic



### MARKING DIAGRAMS



- X, XXX = Specific Device Code
- M = Date Code
- A = Assembly Location
- Y = Year
- W = Work Week
- = Pb-Free Package

### PIN CONNECTIONS

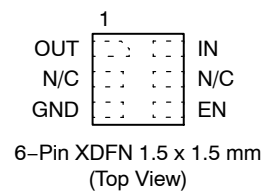
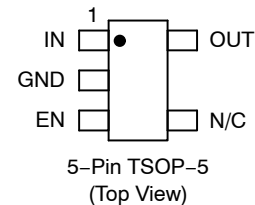

### ORDERING INFORMATION

See detailed ordering and shipping information in the package dimensions section on page 16 of this data sheet.

# NCP703

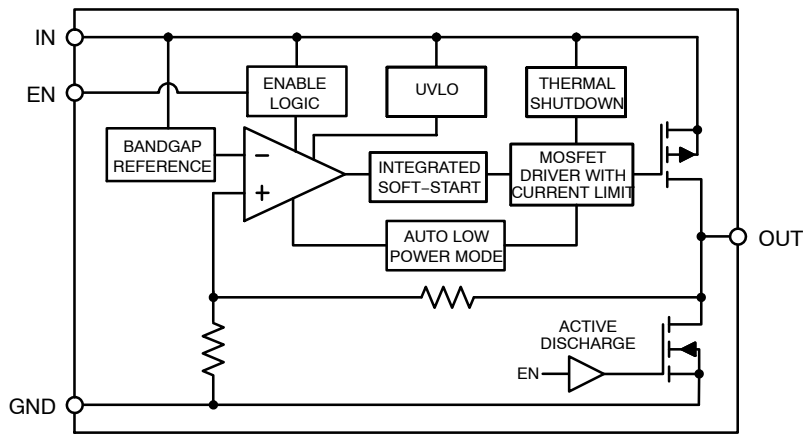

Figure 2. Simplified Schematic Block Diagram

Table 1. PIN FUNCTION DESCRIPTION

Pin No. XDFN6	Pin No. TSOP-5	Pin Name	Description
1	5	OUT	Regulated output voltage pin. A small 1 $\mu$ F ceramic capacitor is needed from this pin to ground to assure stability.
2	4	N/C	Not connected.
3	2	GND	Power supply ground. Connected to the die through the lead frame. Soldered to the copper plane allows for effective heat dissipation.
4	3	EN	Enable pin. Driving EN over 0.9 V turns on the regulator. Driving EN below 0.4 V puts the regulator into shutdown mode.
5		N/C	Not connected. This pin can be tied to ground to improve thermal dissipation.
6	1	IN	Input pin. A small capacitor is needed from this pin to ground to assure stability.

Table 2. ABSOLUTE MAXIMUM RATINGS

Rating	Symbol	Value	Unit
Input Voltage (Note 1)	$V_{IN}$	-0.3 V to 6 V	V
Output Voltage	$V_{OUT}$	-0.3 V to $V_{IN} + 0.3$ V	V
Enable Input	$V_{EN}$	-0.3 V to $V_{IN} + 0.3$ V	V
Output Short Circuit Duration	$t_{SC}$	Indefinite	s
Maximum Junction Temperature	$T_{J(MAX)}$	150	$^{\circ}$ C
Storage Temperature	$T_{STG}$	-55 to 150	$^{\circ}$ C
ESD Capability, Human Body Model (Note 2)	$ESD_{HBM}$	2000	V
ESD Capability, Machine Model (Note 2)	$ESD_{MM}$	200	V

Stresses exceeding those listed in the Maximum Ratings table may damage the device. If any of these limits are exceeded, device functionality should not be assumed, damage may occur and reliability may be affected.

1. Refer to ELECTRICAL CHARACTERISTICS and APPLICATION INFORMATION for Safe Operating Area.
2. This device series incorporates ESD protection and is tested by the following methods:  
 ESD Human Body Model tested per AEC-Q100-002 (EIA/JESD22-A114)  
 ESD Machine Model tested per AEC-Q100-003 (EIA/JESD22-A115)  
 Latchup Current Maximum Rating tested per JEDEC standard: JESD78.

# NCP703

**Table 3. THERMAL CHARACTERISTICS** (Note 3)

Rating	Symbol	Value	Unit
Thermal Characteristics, TSOP-5, Thermal Resistance, Junction-to-Air Thermal Characterization Parameter, Junction-to-Lead (Pin 2)	$\theta_{JA}$ $\psi_{JL}$	241 129	$^{\circ}\text{C}/\text{W}$
Thermal Characteristics, XDFN6 1.5 x 1.5 mm Thermal Resistance, Junction-to-Air Thermal Characterization Parameter, Junction-to-Board	$\theta_{JA}$ $\psi_{JB}$	146 77	$^{\circ}\text{C}/\text{W}$

3. Single component mounted on 1 oz, FR4 PCB with 645 mm<sup>2</sup> Cu area.

**Table 4. ELECTRICAL CHARACTERISTICS**

$-40^{\circ}\text{C} \leq T_J \leq 125^{\circ}\text{C}$ ;  $V_{IN} = V_{OUT(NOM)} + 0.5 \text{ V}$  or  $2.0 \text{ V}$ , whichever is greater;  $V_{EN} = 0.9 \text{ V}$ ,  $I_{OUT} = 10 \text{ mA}$ ,  $C_{IN} = C_{OUT} = 1 \mu\text{F}$  unless otherwise noted. Typical values are at  $T_J = +25^{\circ}\text{C}$ . (Note 4)

Parameter	Test Conditions	Symbol	Min	Typ	Max	Unit
Operating Input Voltage		$V_{IN}$	2.0		5.5	V
Undervoltage Lock-out	$V_{IN}$ rising	UVLO	1.2	1.6	1.9	V
Output Voltage Accuracy	$V_{OUT} + 0.5 \text{ V} \leq V_{IN} \leq 5.5 \text{ V}$ , $I_{OUT} = 0 - 300 \text{ mA}$	$V_{OUT}$	-2		+2	%
Line Regulation	$V_{OUT} + 0.5 \text{ V} \leq V_{IN} \leq 4.5 \text{ V}$ , $I_{OUT} = 10 \text{ mA}$	RegLINE		450		$\mu\text{V}/\text{V}$
	$V_{OUT} + 0.5 \text{ V} \leq V_{IN} \leq 5.5 \text{ V}$ , $I_{OUT} = 10 \text{ mA}$	RegLINE		600		$\mu\text{V}/\text{V}$
Load Regulation	$I_{OUT} = 0 \text{ mA}$ to $300 \text{ mA}$	RegLOAD		20		$\mu\text{V}/\text{mA}$
Load Transient	$I_{OUT} = 1 \text{ mA}$ to $300 \text{ mA}$ or $300 \text{ mA}$ to $1 \text{ mA}$ in $1 \mu\text{s}$ , $C_{OUT} = 1 \mu\text{F}$	TranLOAD		-100/ +150		mV
Dropout Voltage (Note 5)	$I_{OUT} = 300 \text{ mA}$ , $V_{OUT(nom)} = 2.5 \text{ V}$	$V_{DO}$		180	300	mV
Output Current Limit	$V_{OUT} = 90\% V_{OUT(nom)}$	$I_{CL}$	310	450	750	mA
Quiescent Current	$I_{OUT} = 0 \text{ mA}$	$I_Q$		12	20	$\mu\text{A}$
Ground Current	$I_{OUT} = 300 \text{ mA}$	$I_{GND}$		200		$\mu\text{A}$
Shutdown Current	$V_{EN} \leq 0.4 \text{ V}$ , $T_J = +25^{\circ}\text{C}$	$I_{DIS}$		0.12		$\mu\text{A}$
	$V_{EN} \leq 0 \text{ V}$ , $V_{IN} = 2.0$ to $4.5 \text{ V}$ , $T_J = -40$ to $+85^{\circ}\text{C}$	$I_{DIS}$		0.55	2	$\mu\text{A}$
EN Pin Threshold Voltage						V
High Threshold	$V_{EN}$ Voltage increasing	$V_{EN\_HI}$	0.9			
Low Threshold	$V_{EN}$ Voltage decreasing	$V_{EN\_LO}$			0.4	
EN Pin Input Current	$V_{EN} = 5.5 \text{ V}$	$I_{EN}$		100	500	nA
Turn-On Time	$C_{OUT} = 1.0 \mu\text{F}$ , from assertion EN pin to 98% $V_{OUT(nom)}$	$t_{ON}$		200		$\mu\text{s}$
Power Supply Rejection Ratio	$V_{IN} = 3 \text{ V}$ , $V_{OUT} = 2.5 \text{ V}$ $I_{OUT} = 300 \text{ mA}$	PSRR	$f = 100 \text{ Hz}$	70		dB
			$f = 1 \text{ kHz}$	68		
			$f = 10 \text{ kHz}$	53		
Output Noise Voltage	$V_{OUT} = 2.5 \text{ V}$ , $V_{IN} = 3 \text{ V}$ , $I_{OUT} = 300 \text{ mA}$ $f = 100 \text{ Hz}$ to $100 \text{ kHz}$	$V_N$		13		$\mu\text{V}_{\text{rms}}$
Thermal Shutdown Temperature	Temperature increasing from $T_J = +25^{\circ}\text{C}$	$T_{SD}$		160		$^{\circ}\text{C}$
Thermal Shutdown Hysteresis	Temperature falling from $T_{SD}$	$T_{SDH}$	-	20	-	$^{\circ}\text{C}$

Product parametric performance is indicated in the Electrical Characteristics for the listed test conditions, unless otherwise noted. Product performance may not be indicated by the Electrical Characteristics if operated under different conditions.

- Performance guaranteed over the indicated operating temperature range by design and/or characterization. Production tested at  $T_J = T_A = 25^{\circ}\text{C}$ . Low duty cycle pulse techniques are used during testing to maintain the junction temperature as close to ambient as possible.
- Characterized when  $V_{OUT}$  falls 100 mV below the regulated voltage at  $V_{IN} = V_{OUT(NOM)} + 0.5 \text{ V}$ .

TYPICAL CHARACTERISTICS

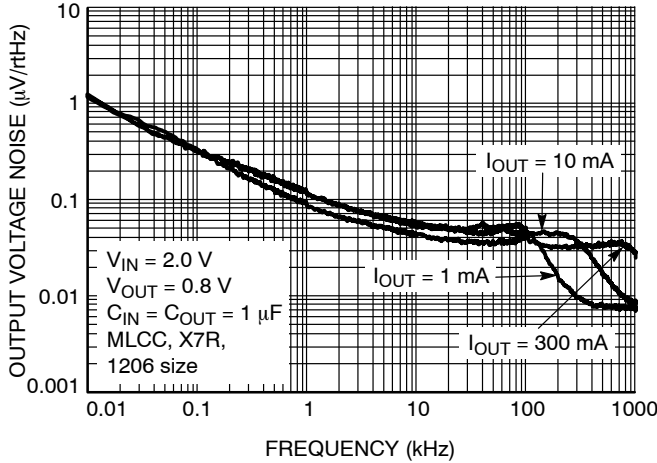

I <sub>OUT</sub>	RMS Output Noise (μV)	
	10 Hz – 100 kHz	100 Hz – 100 kHz
1 mA	18.45	17.77
10 mA	17.18	16.43
300 mA	14.14	13.11

Figure 3. Output Voltage Noise Spectral Density for V<sub>OUT</sub> = 0.8 V, C<sub>OUT</sub> = 1 μF

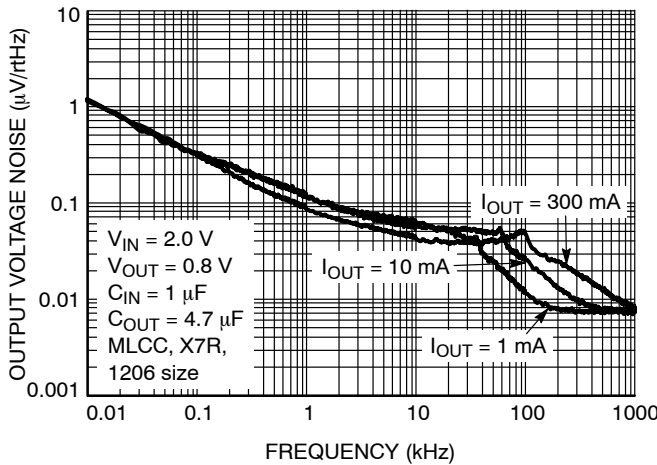

I <sub>OUT</sub>	RMS Output Noise (μV)	
	10 Hz – 100 kHz	100 Hz – 100 kHz
1 mA	14.07	13.14
10 mA	16.59	15.83
300 mA	15.46	14.53

Figure 4. Output Voltage Noise Spectral Density for V<sub>OUT</sub> = 0.8 V, C<sub>OUT</sub> = 4.7 μF

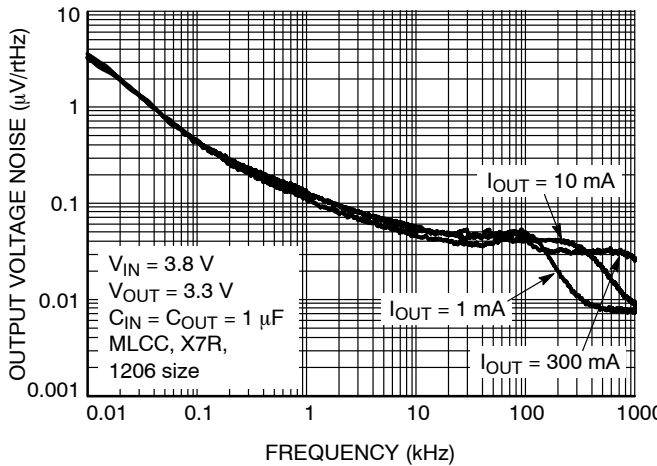

I <sub>OUT</sub>	RMS Output Noise (μV)	
	10 Hz – 100 kHz	100 Hz – 100 kHz
1 mA	20.29	17.06
10 mA	19.76	16.11
300 mA	18.74	15.46

Figure 5. Output Voltage Noise Spectral Density for V<sub>OUT</sub> = 3.3 V, C<sub>OUT</sub> = 1 μF

TYPICAL CHARACTERISTICS

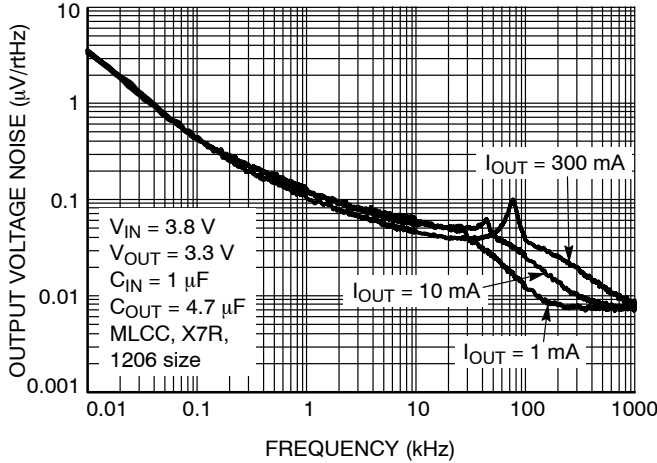

I <sub>OUT</sub>	RMS Output Noise (µV)	
	10 Hz – 100 kHz	100 Hz – 100 kHz
1 mA	17.64	13.52
10 mA	19.54	15.96
300 mA	21.50	18.71

Figure 6. Output Voltage Noise Spectral Density for V<sub>OUT</sub> = 3.3 V, C<sub>OUT</sub> = 4.7 µF

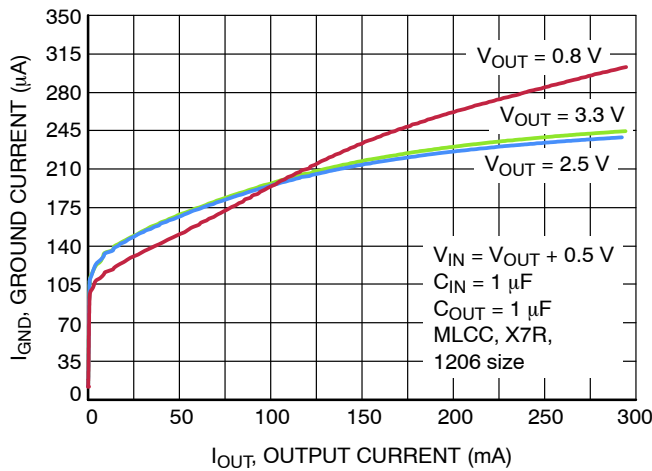

Figure 7. Ground Current vs. Output Current

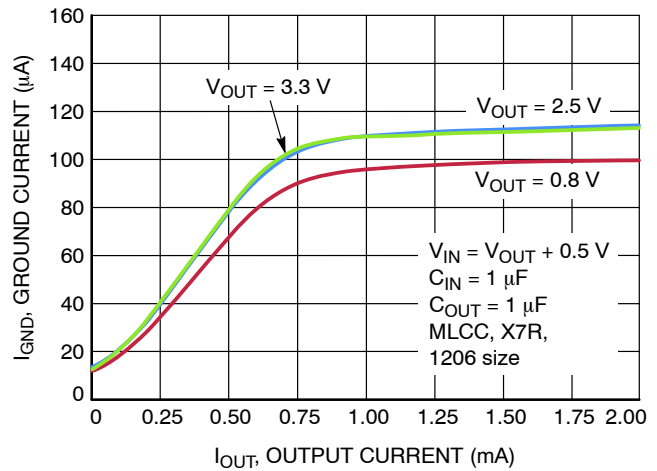

Figure 8. Ground Current vs. Output Current from 0 mA to 2 mA

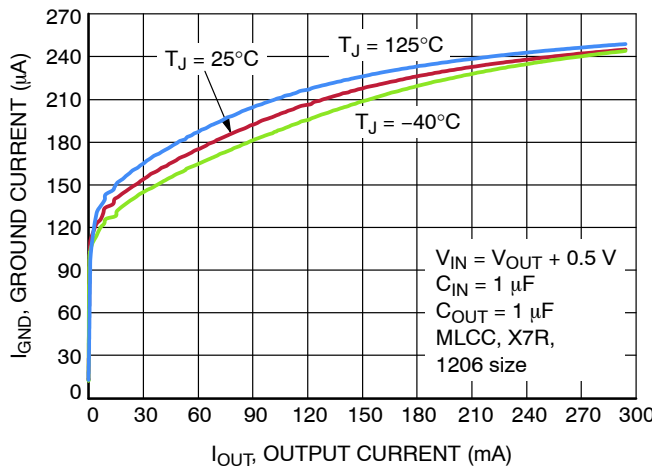

Figure 9. Ground Current vs. Output Current at Temperatures

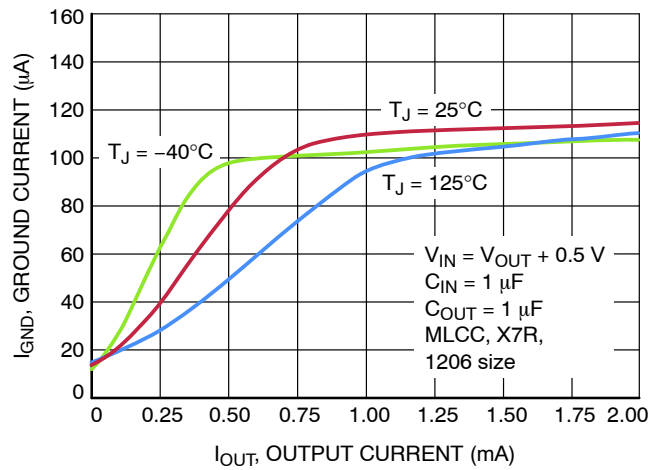

Figure 10. Ground Current vs. Output Current 0 mA to 2 mA at Temperatures

TYPICAL CHARACTERISTICS

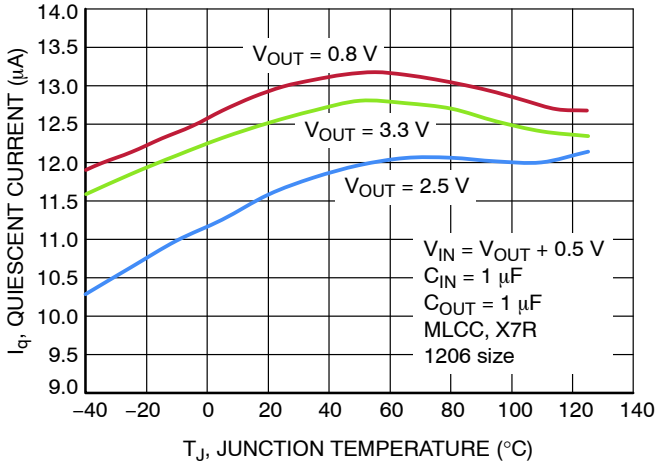

Figure 11. Quiescent Current vs. Temperature

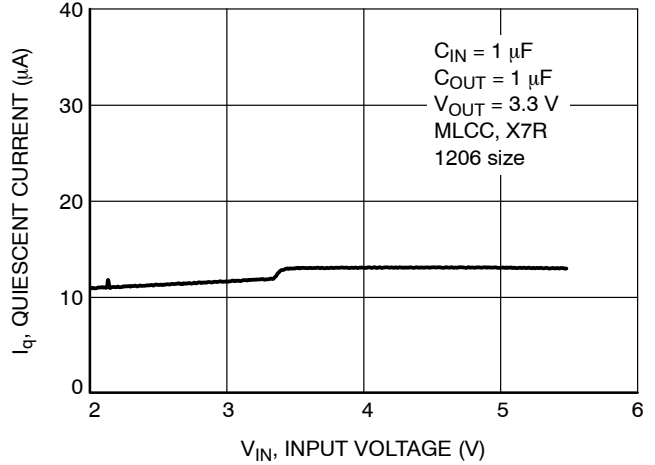

Figure 12. Quiescent Current vs. Input Voltage

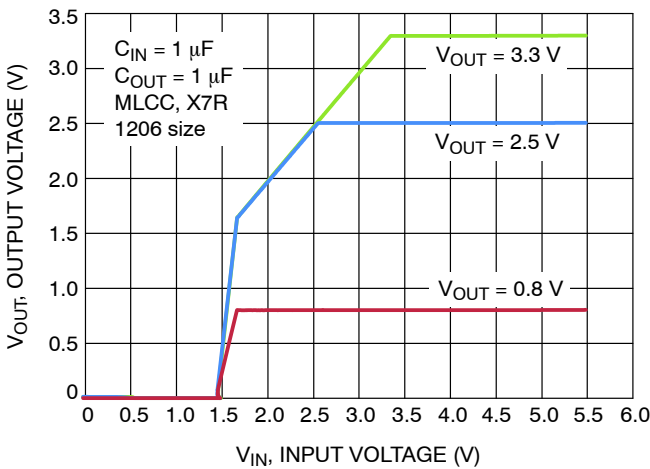

Figure 13. Output Voltage vs. Input Voltage

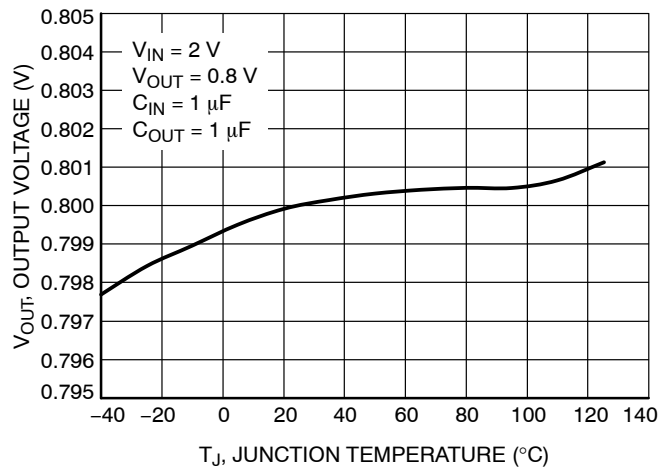

Figure 14. Output Voltage vs. Temperature – 0.8 V

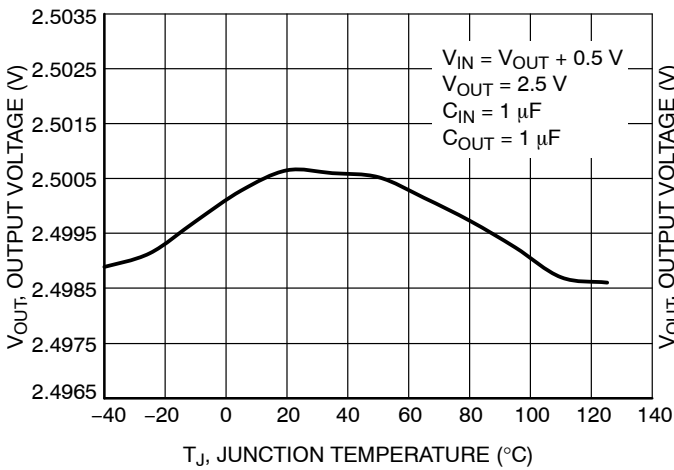

Figure 15. Output Voltage vs. Temperature – 2.5 V

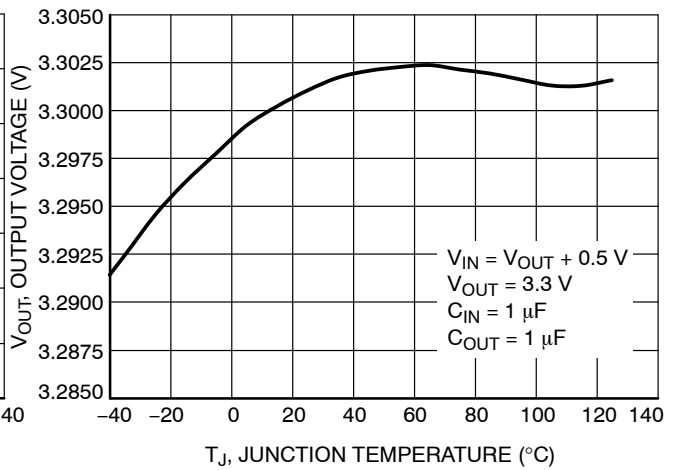
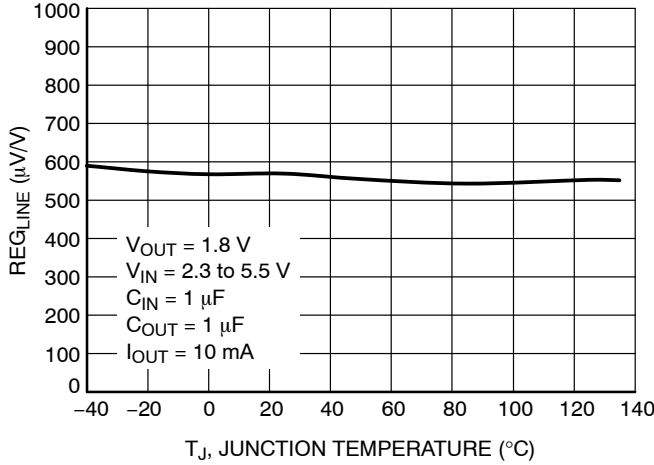

Figure 16. Output Voltage vs. Temperature – 3.3 V

# NCP703

## TYPICAL CHARACTERISTICS



**Figure 17. Line Regulation vs. Temperature – 1.8 V**

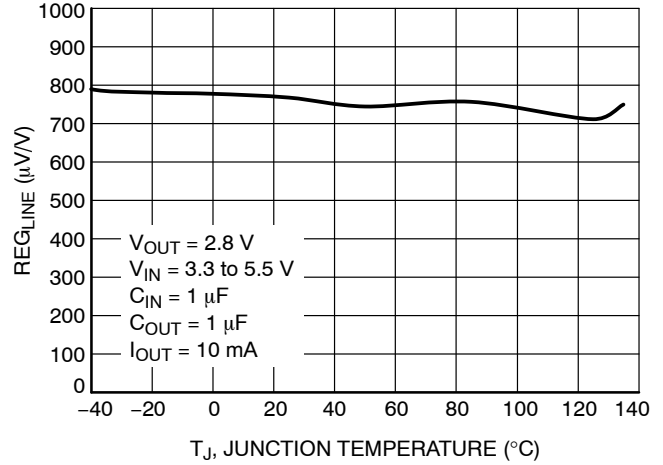

**Figure 18. Line Regulation vs. Temperature – 2.8 V**

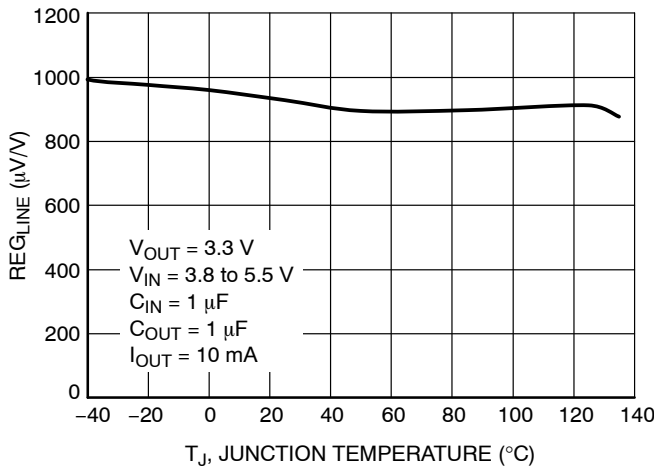

**Figure 19. Line Regulation vs. Temperature – 3.3 V**

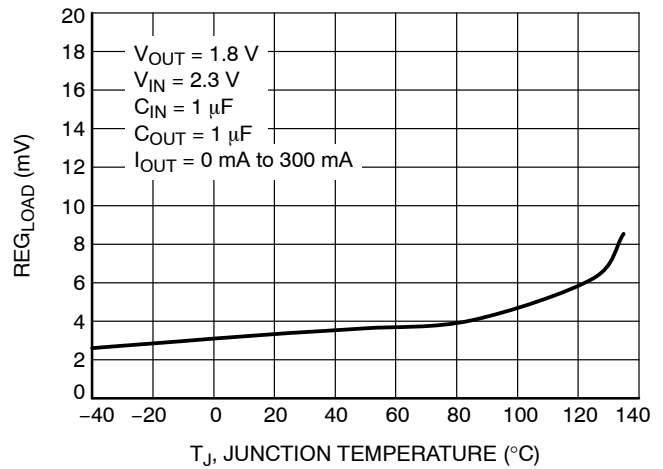

**Figure 20. Load Regulation vs. Temperature – 1.8 V**

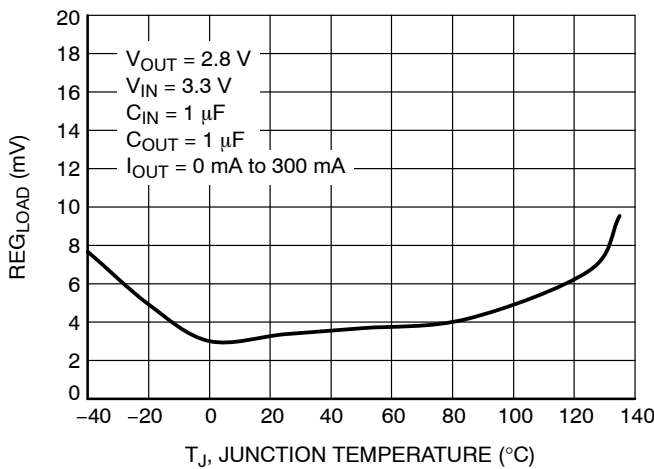

**Figure 21. Load Regulation vs. Temperature – 2.8 V**

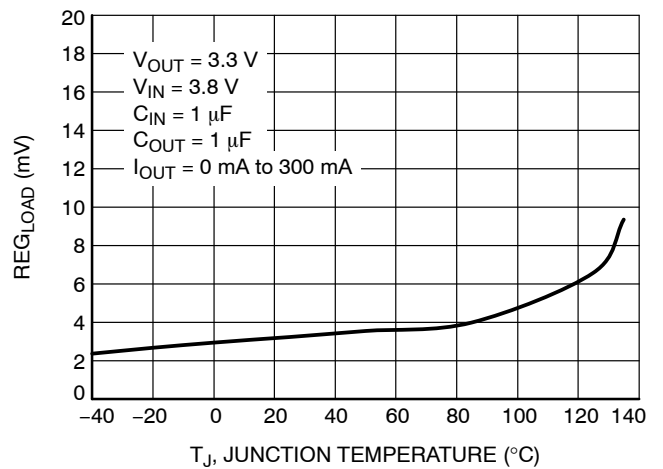

**Figure 22. Load Regulation vs. Temperature – 3.3 V**

TYPICAL CHARACTERISTICS

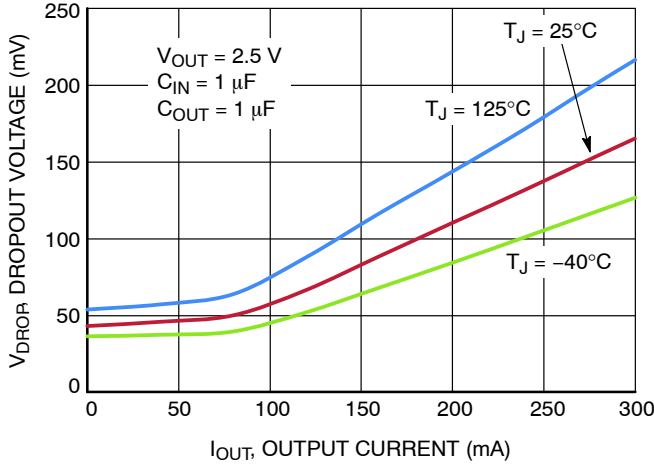

Figure 23. Dropout vs. Output Current – 2.5 V

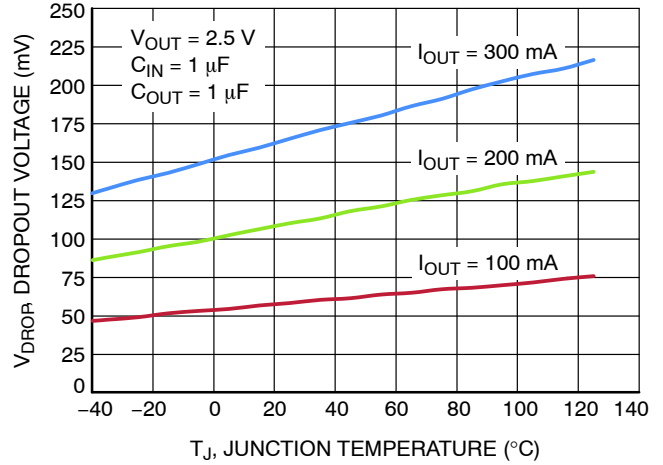

Figure 24. Dropout vs. Temperature – 2.5 V

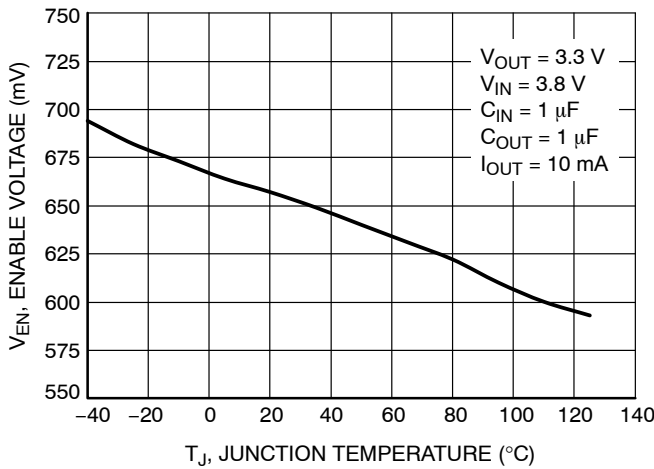

Figure 25. Enable Threshold – High

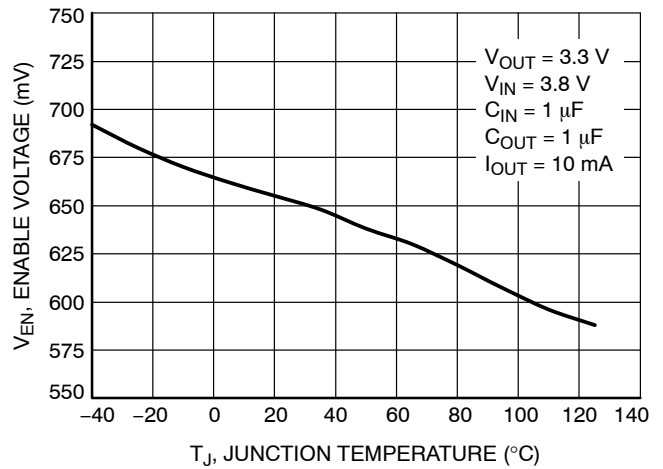

Figure 26. Enable Threshold – Low

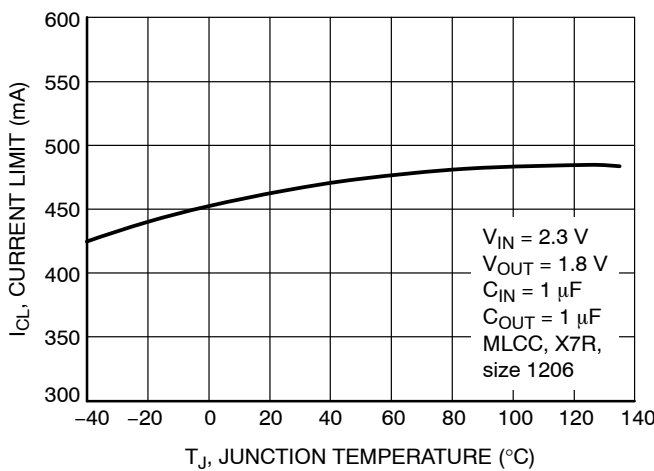

Figure 27. Output Current Limit

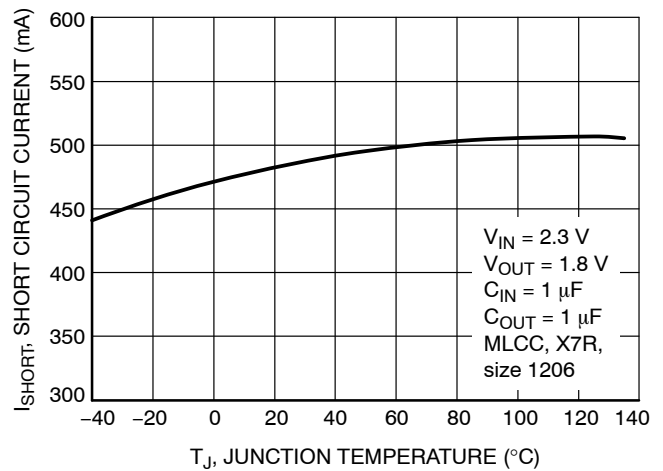

Figure 28. Short Circuit Limit



TYPICAL CHARACTERISTICS

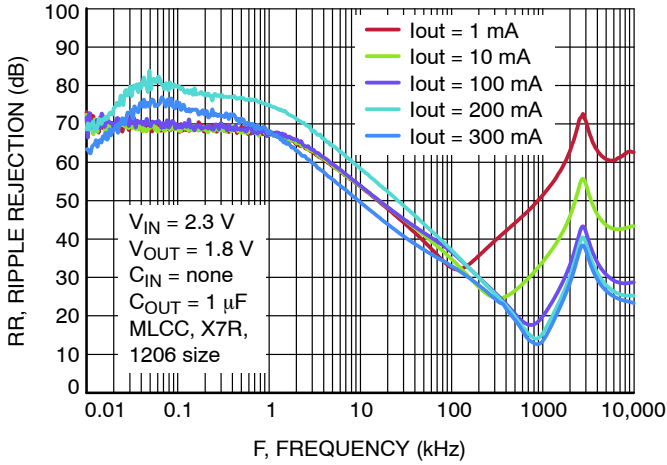

Figure 29. Power Supply Rejection Ratio,  $V_{OUT} = 1.8\text{ V}$

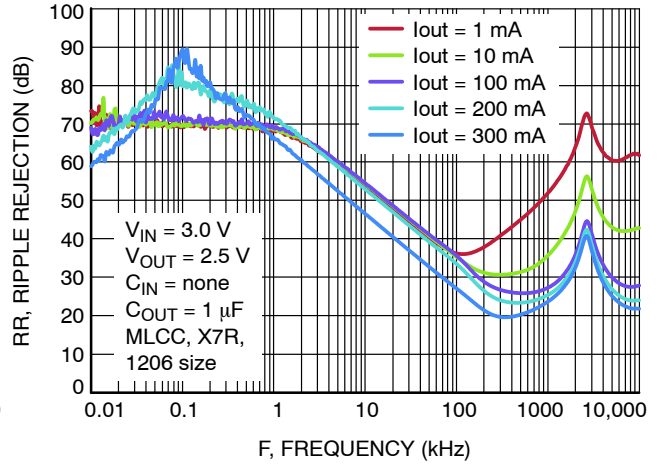

Figure 30. Power Supply Rejection Ratio,  $V_{OUT} = 2.5\text{ V}$

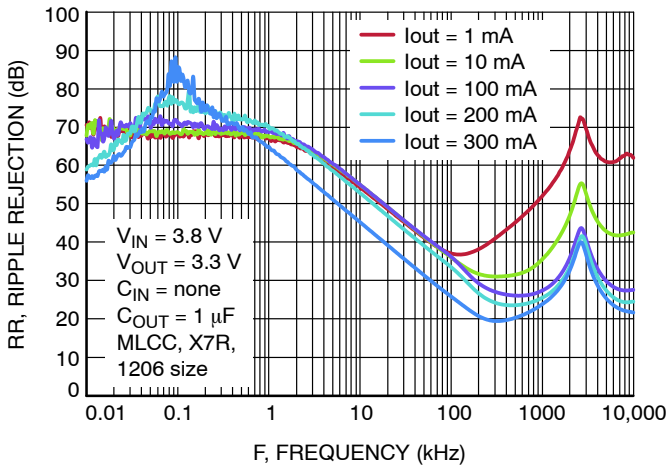

Figure 31. Power Supply Rejection Ratio,  $V_{OUT} = 3.3\text{ V}$

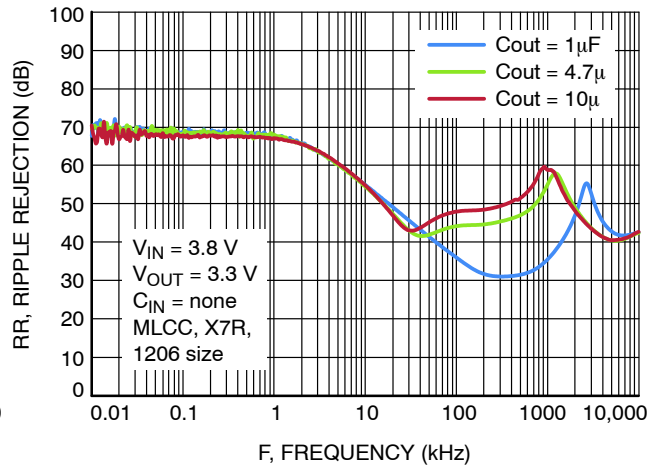

Figure 32. Power Supply Rejection Ratio,  $V_{OUT} = 3.3\text{ V}$ ,  $I_{OUT} = 10\text{ mA}$

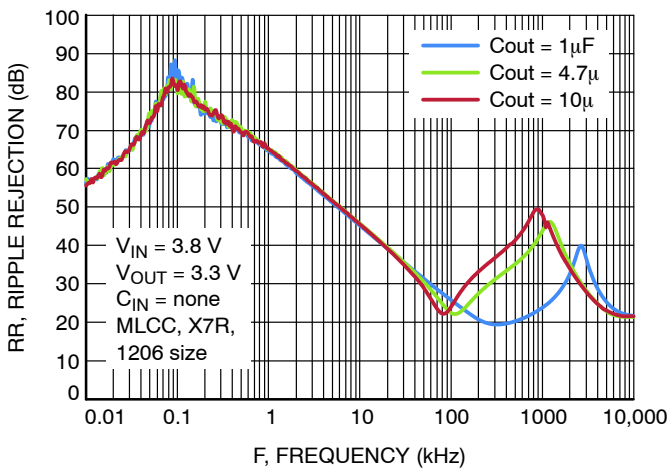

Figure 33. Power Supply Rejection Ratio,  $V_{OUT} = 3.3\text{ V}$ ,  $I_{OUT} = 300\text{ mA}$

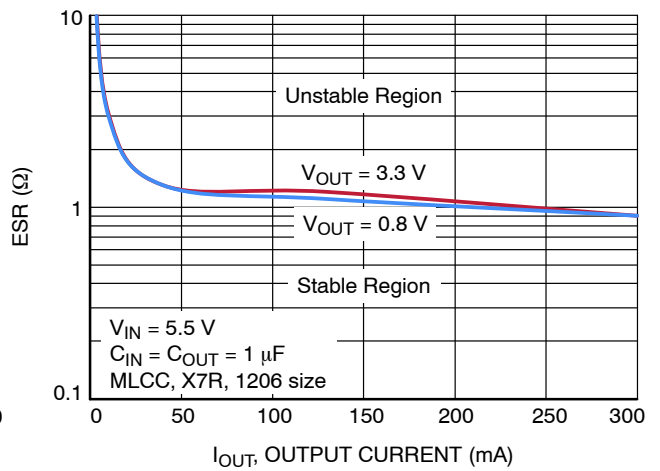

Figure 34. Output Capacitor ESR vs. Output Current

TYPICAL CHARACTERISTICS

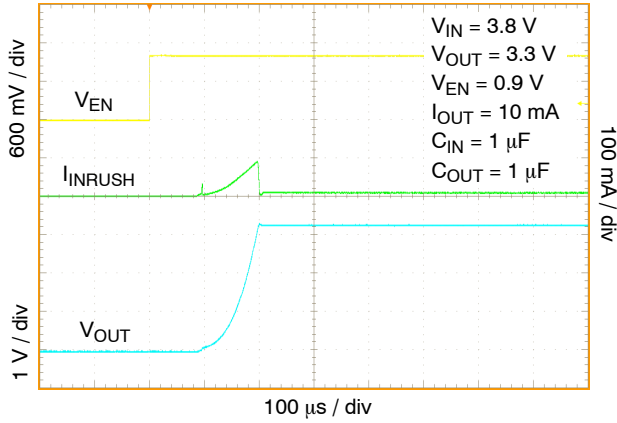

Figure 35. Enable Turn-on Response –  $C_{OUT} = 1 \mu F$

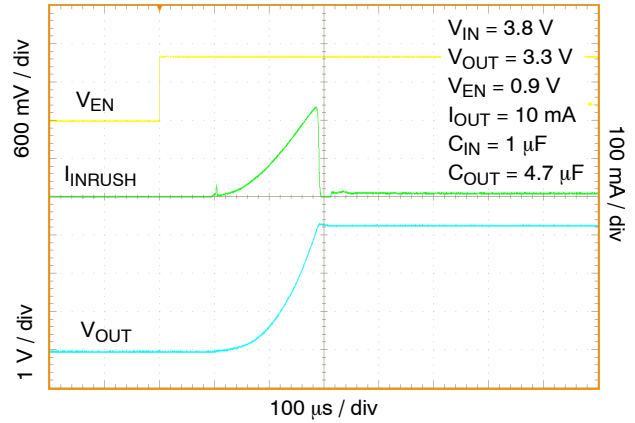

Figure 36. Enable Turn-on Response –  $C_{OUT} = 4.7 \mu F$

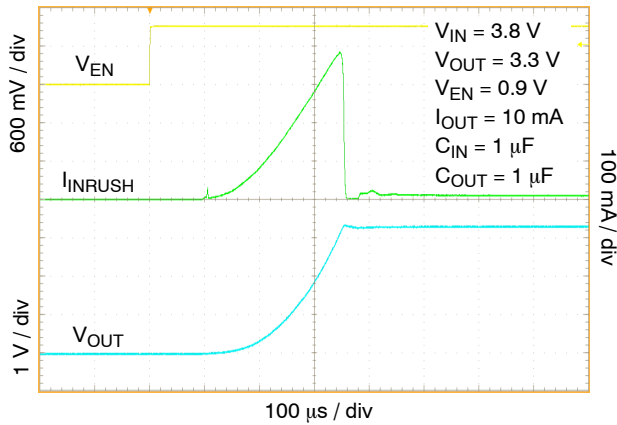

Figure 37. Enable Turn-on Response –  $C_{OUT} = 10 \mu F$

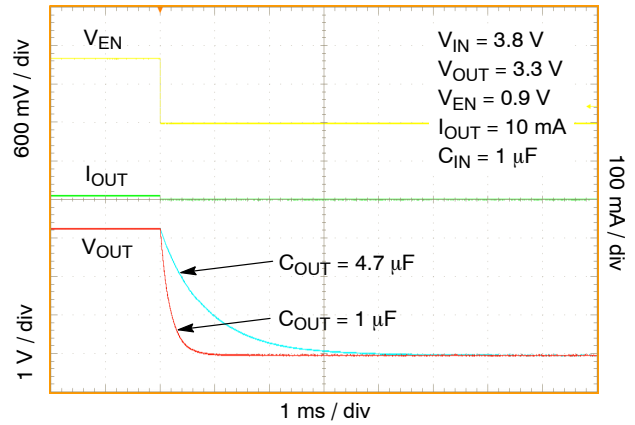

Figure 38. Enable Turn-off Response

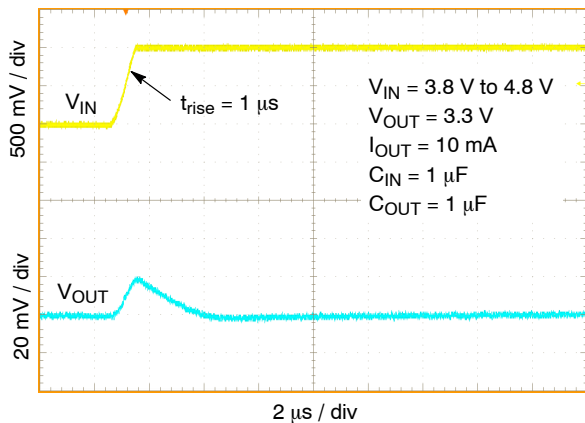

Figure 39. Line Transient Response – Rising Edge,  $V_{OUT} = 3.3 V$

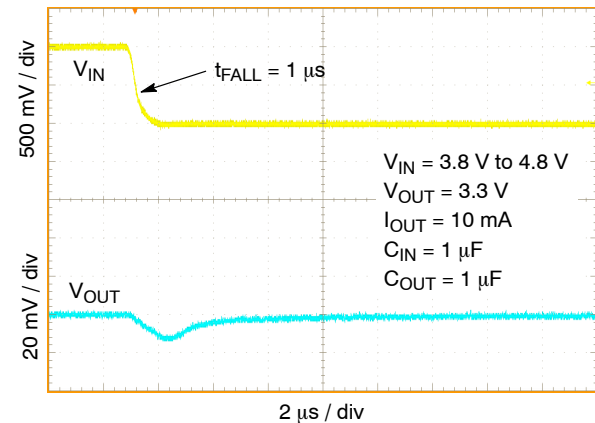
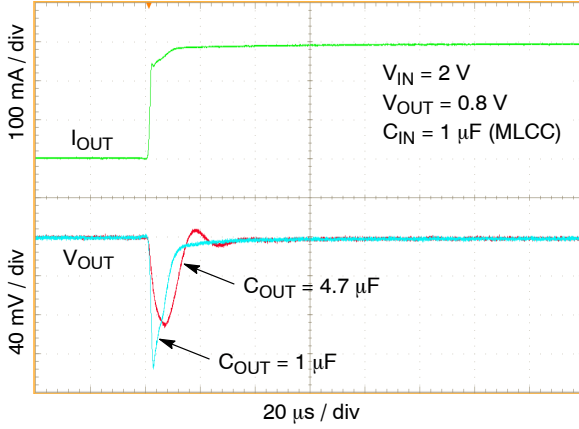
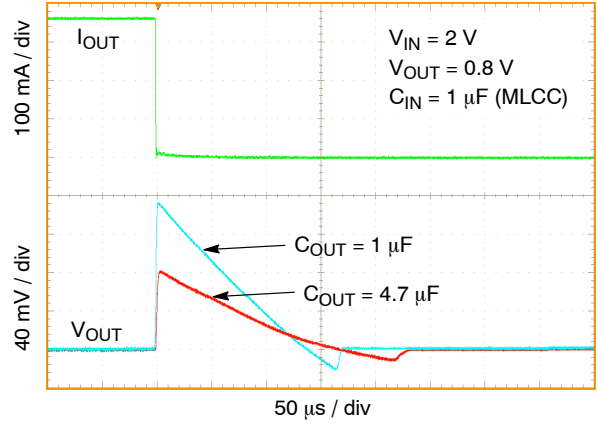

Figure 40. Line Transient Response – Falling Edge,  $V_{OUT} = 3.3 V$

TYPICAL CHARACTERISTICS



**Figure 41. Load Transient Response – Rising Edge,  $V_{OUT} = 0.8 V$ ,  $I_{OUT} = 1 mA$  to  $300 mA$ ,  $C_{OUT} = 1 \mu F$ ,  $4.7 \mu F$**



**Figure 42. Load Transient Response – Falling Edge,  $V_{OUT} = 0.8 V$ ,  $I_{OUT} = 1 mA$  to  $300 mA$ ,  $C_{OUT} = 1 \mu F$ ,  $4.7 \mu F$**

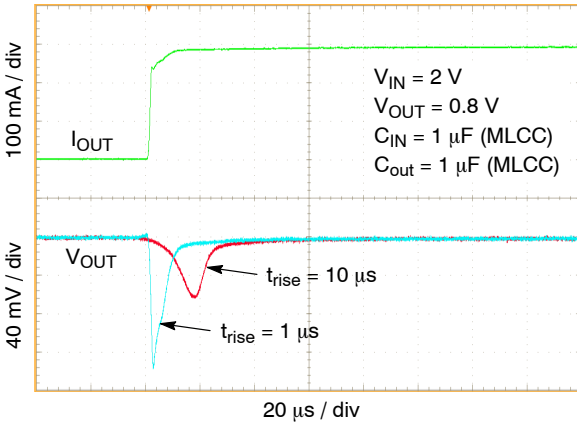

**Figure 43. Load Transient Response – Rising Edge,  $V_{OUT} = 0.8 V$ ,  $I_{OUT} = 1 mA$  to  $300 mA$ ,  $t_{RISE} = 1 \mu s$ ,  $10 \mu s$**

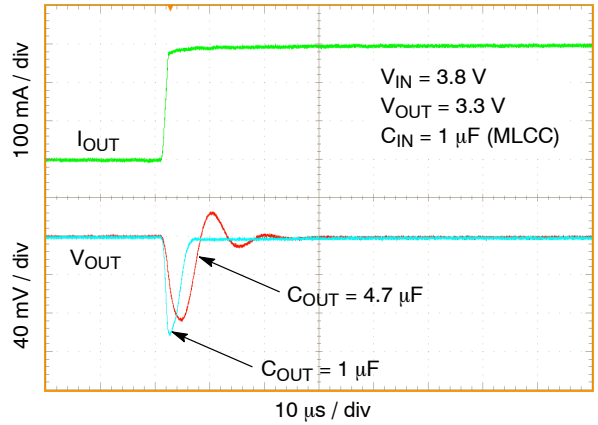

**Figure 44. Load Transient Response – Rising Edge,  $V_{OUT} = 3.3 V$ ,  $I_{OUT} = 1 mA$  to  $300 mA$ ,  $C_{OUT} = 1 \mu F$ ,  $4.7 \mu F$**

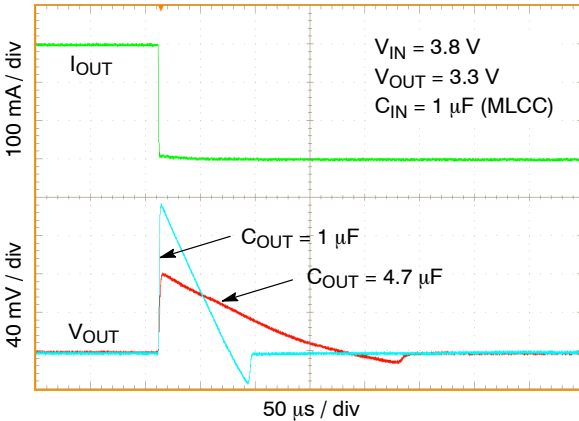

**Figure 45. Load Transient Response – Falling Edge,  $V_{OUT} = 3.3 V$ ,  $I_{OUT} = 1 mA$  to  $300 mA$ ,  $C_{OUT} = 1 \mu F$ ,  $4.7 \mu F$**

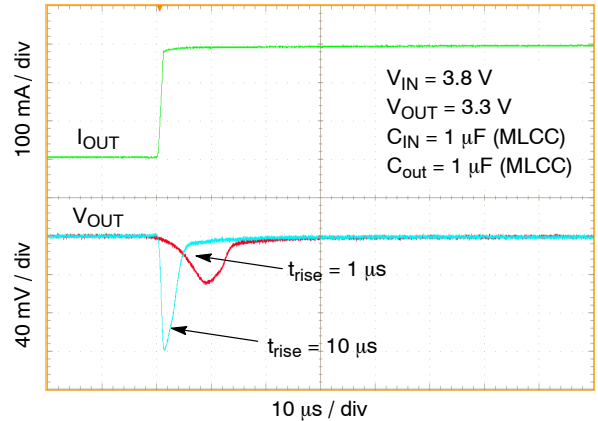

**Figure 46. Load Transient Response – Rising Edge,  $V_{OUT} = 3.3 V$ ,  $I_{OUT} = 1 mA$  to  $300 mA$ ,  $t_{RISE} = 1 \mu s$ ,  $10 \mu s$**

TYPICAL CHARACTERISTICS

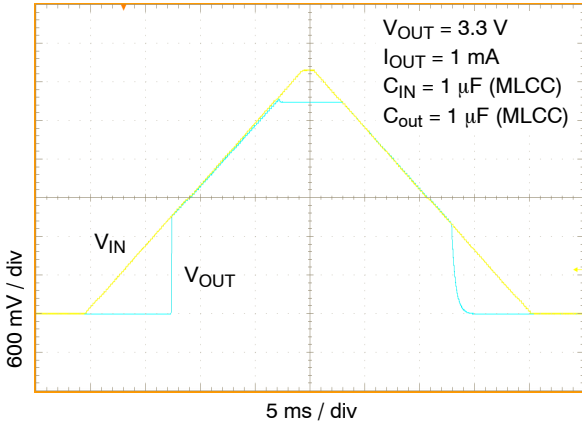

Figure 47. Turn-on/off – Slow Rising  $V_{IN}$

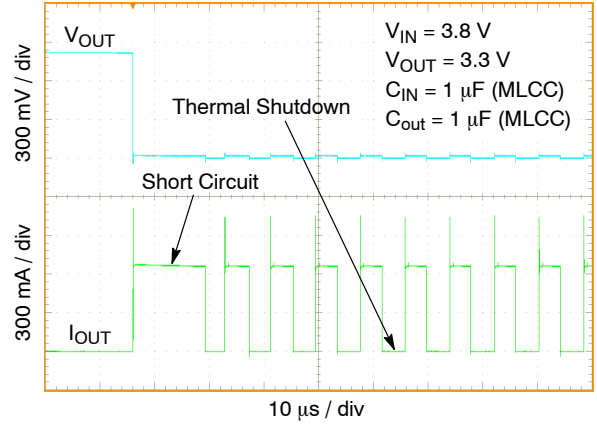

Figure 48. Short Circuit and Thermal Shutdown

APPLICATIONS INFORMATION

**General**

The NCP703 is a high performance 300 mA Low Dropout Linear Regulator. This device delivers excellent noise and dynamic performance. Thanks to its adaptive ground current feature the device consumes only 12  $\mu$ A of quiescent current at no-load condition. The regulator features ultra-low noise of 13  $\mu$ V<sub>RMS</sub>, PSRR of 68 dB at 1 kHz and very good load/line transient performance. Such excellent dynamic parameters and small package size make the device an ideal choice for powering the precision analog and noise sensitive circuitry in portable applications. The LDO achieves this ultra low noise level output without the need for a noise bypass capacitor. A logic EN input provides ON/OFF control of the output voltage. When the EN is low the device consumes as low as typ. 120 nA from the IN pin. The device is fully protected in case of output overload, output short circuit condition and overheating, assuring a very robust design.

**Input Capacitor Selection (CIN)**

It is recommended to connect a minimum of 1  $\mu$ F Ceramic X5R or X7R capacitor close to the IN pin of the device. This capacitor will provide a low impedance path for unwanted AC signals or noise modulated onto constant input voltage. There is no requirement for the min. /max. ESR of the input capacitor but it is recommended to use ceramic capacitors for their low ESR and ESL. A good input capacitor will limit the influence of input trace inductance and source resistance during sudden load current changes. Larger input capacitor may be necessary if fast and large load transients are encountered in the application.

**Output Decoupling (COUT)**

The NCP703 requires an output capacitor connected as close as possible to the output pin of the regulator. The recommended capacitor value is 1  $\mu$ F and X7R or X5R dielectric due to its low capacitance variations over the specified temperature range. The NCP703 is designed to remain stable with minimum effective capacitance of 0.1  $\mu$ F to account for changes with temperature, DC bias and package size. Especially for small package size capacitors such as 0402 the effective capacitance drops rapidly with the applied DC bias. Refer to the Figure 49, for the capacitance vs. package size and DC bias voltage dependence.

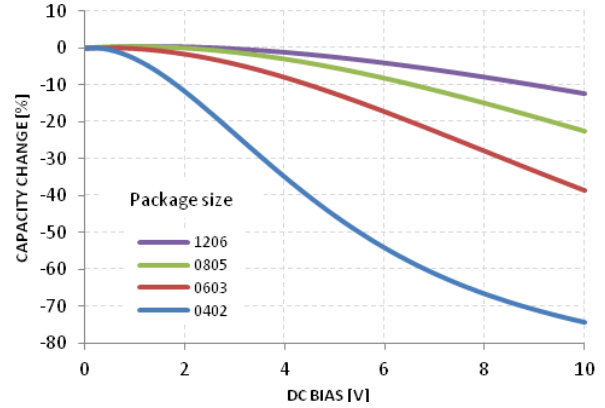

**Figure 49. Capacitance Change vs. DC Bias**

There is no requirement for the minimum value of Equivalent Series Resistance (ESR) for the C<sub>OUT</sub> but the maximum value of ESR should be less than 900 m $\Omega$ . Larger output capacitors and lower ESR could improve the load transient response or high frequency PSRR as shown in typical characteristics. It is not recommended to use tantalum capacitors on the output due to their large ESR. The equivalent series resistance of tantalum capacitors is also strongly dependent on the temperature, increasing at low temperature. The tantalum capacitors are generally more costly than ceramic capacitors.

**No-load Operation**

The regulator remains stable and regulates the output voltage properly within the  $\pm 2\%$  tolerance limits even with no external load applied to the output.

**Enable Operation**

The EN pin is used to enable/disable the LDO and to deactivate/activate the active discharge function.

If the EN pin voltage is <0.4 V the device is guaranteed to be disabled. The pass transistor is turned-off so that there is virtually no current flow between the IN and OUT. The active discharge transistor is active so that the output voltage V<sub>OUT</sub> is pulled to GND through a 320  $\Omega$  resistor. In the disable state the device consumes as low as typ. 120 nA from the V<sub>IN</sub>.

If the EN pin voltage >0.9 V the device is guaranteed to be enabled. The NCP703 regulates the output voltage and the active discharge transistor is turned-off.

APPLICATIONS INFORMATION

The EN pin has internal pull-down current source with typ. value of 110 nA which assures that the device is turned-off when the EN pin is not connected. Built in 2 mV hysteresis into the EN prevents from periodic on/off oscillations that can occur due to noise.

In the case where the EN function isn't required the EN should be tied directly to IN.

**Undervoltage Lockout**

The internal UVLO circuitry assures that the device becomes disabled when the  $V_{IN}$  falls below typ. 1.5 V. When the  $V_{IN}$  voltage ramps-up the NCP703 becomes enabled, if  $V_{IN}$  rises above typ. 1.6 V. The 100 mV hysteresis prevents from on/off oscillations that can occur due to noise on  $V_{IN}$  line.

**Output Current Limit**

Output Current is internally limited within the IC to a typical 490 mA. The NCP703 will source this amount of current if the output voltage drops down to 90% of the nominal  $V_{OUT}$ . When the Output Voltage is directly shorted to ground ( $V_{OUT} = 0$  V), the short circuit protection will limit the output current to 520 mA (typ). The current limit and short circuit protection will work properly up to  $V_{IN} = 5.5$  V at  $T_A = 25^\circ\text{C}$ . There is no limitation for the short circuit duration.

**Internal Soft-Start circuit**

NCP703 contains an internal soft-start circuitry to protect against large inrush currents which could otherwise flow during the start-up of the regulator. Soft-start feature protects against power bus disturbances and assures a controlled and monotonic rise of the output voltage.

**Thermal Shutdown**

When the die temperature exceeds the Thermal Shutdown threshold ( $T_{SD} - 160^\circ\text{C}$  typical), Thermal Shutdown event is detected and the device is disabled. The IC will remain in this state until the die temperature decreases below the Thermal Shutdown Reset threshold ( $T_{SDU} - 140^\circ\text{C}$  typical). Once the IC temperature falls below the  $140^\circ\text{C}$  the LDO is enabled again. The thermal shutdown feature provides the protection from a catastrophic device failure due to accidental overheating. This protection is not intended to be used as a substitute for proper heat sinking. For reliable operation junction temperature should be limited to  $+125^\circ\text{C}$  maximum.

**Power Dissipation**

As power dissipated in the NCP703 increases, it might become necessary to provide some thermal relief. The maximum power dissipation supported by the device is dependent upon board design and layout. Mounting pad configuration on the PCB, the board material, and the ambient temperature affect the rate of junction temperature rise for the part.

The maximum power dissipation the NCP703 can handle is given by:

$$P_{D(MAX)} = \frac{[+125^\circ\text{C} - T_A]}{\theta_{JA}} \quad (\text{eq. 1})$$

The power dissipated by the NCP703 for given application conditions can be calculated from the following equations:

$$P_D \approx V_{IN}(I_{GND@I_{OUT}}) + I_{OUT}(V_{IN} - V_{OUT}) \quad (\text{eq. 2})$$

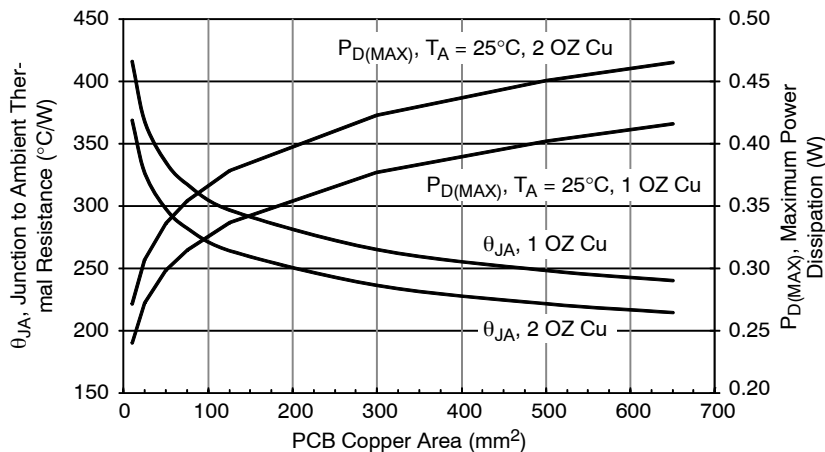

Figure 50.  $\theta_{JA}$  and  $P_{D(MAX)}$  vs. Copper Area (TSOP-5)

APPLICATIONS INFORMATION

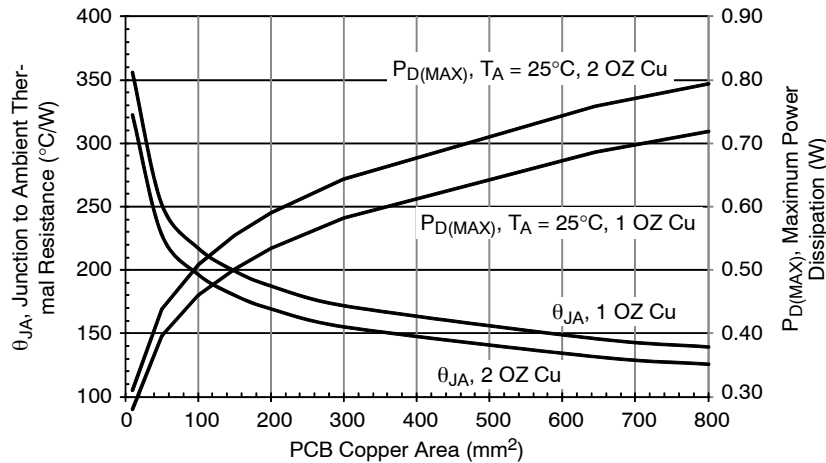

Figure 51.  $\theta_{JA}$  vs. Copper Area (XDFN6)

**Reverse Current**

The PMOS pass transistor has an inherent body diode which will be forward biased in the case that  $V_{OUT} > V_{IN}$ . Due to this fact in cases, where the extended reverse current condition can be anticipated the device may require additional external protection.

**Load Regulation**

The NCP703 features very good load regulation of typically 6 mV in 0 mA to 300 mA range. In order to achieve this very good load regulation a special attention to PCB design is necessary. The trace resistance from the OUT pin to the point of load can easily approach 100 m $\Omega$  which will cause 30 mV voltage drop at full load current, deteriorating the excellent load regulation.

**Line Regulation**

The IC features very good line regulation of 0.6 mV/V measured from  $V_{IN} = V_{OUT} + 0.5$  V to 5.5 V. For battery operated applications it may be important that the line regulation from  $V_{IN} = V_{OUT} + 0.5$  V up to 4.5 V is only 0.45 mV/V.

**Power Supply Rejection Ratio**

The NCP703 features very good Power Supply Rejection ratio. If desired the PSRR at higher frequencies in the range 100 kHz – 10 MHz can be tuned by the selection of  $C_{OUT}$  capacitor and proper PCB layout.

**Output Noise**

The IC is designed for ultra-low noise output voltage without external noise filter capacitor ( $C_{nr}$ ). Figures 3 – 6 shows NCP703 noise performance. Generally the noise performance in the indicated frequency range improves with increasing output current.

Although even at  $I_{OUT} = 1$  mA the noise levels are below 20  $\mu V_{RMS}$ .

**Turn-On Time**

The turn-on time is defined as the time period from EN assertion to the point in which  $V_{OUT}$  will reach 98% of its nominal value. This time is dependent on various application conditions such as  $V_{OUT(NOM)}$ ,  $C_{OUT}$ ,  $T_A$ .

**PCB Layout Recommendations**

To obtain good transient performance and good regulation characteristics place  $C_{IN}$  and  $C_{OUT}$  capacitors close to the device pins and make the PCB traces wide. In order to minimize the solution size, use 0402 capacitors. Larger copper area connected to the pins will also improve the device thermal resistance. The actual power dissipation can be calculated from Equation 2.

# NCP703

## ORDERING INFORMATION

Device	Voltage Option	Marking	Package	Shipping †
NCP703MX18TCG (Note 6)	1.8 V	J	XDFN6	3000 or 5000 / Tape & Reel (Note 6)
NCP703MX28TCG (Note 6)	2.8 V	K		
NCP703MX30TCG	3.0 V	L		
NCP703MX33TCG	3.3 V	P		
NCP703SN18T1G	1.8 V	AEC	TSOP5	3000 / Tape & Reel
NCP703SN19T1G	1.9 V	AEG		
NCP703SN28T1G	2.8 V	AED		
NCP703SN30T1G	3.0 V	AEE		
NCP703SN33T1G	3.3 V	AEF		
NCP703SN35T1G	3.5 V	AEH		

†For information on tape and reel specifications, including part orientation and tape sizes, please refer to our Tape and Reel Packaging Specifications Brochure, BRD8011/D.

6. Product processed after October 1, 2022 are shipped with quantity 5000 units / tape & reel.



# MECHANICAL CASE OUTLINE

## PACKAGE DIMENSIONS

ON Semiconductor®

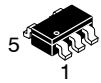

SCALE 2:1

### TSOP-5 CASE 483 ISSUE N

DATE 12 AUG 2020



NOTES:

1. DIMENSIONING AND TOLERANCING PER ASME Y14.5M, 1994.
2. CONTROLLING DIMENSION: MILLIMETERS.
3. MAXIMUM LEAD THICKNESS INCLUDES LEAD FINISH THICKNESS. MINIMUM LEAD THICKNESS IS THE MINIMUM THICKNESS OF BASE MATERIAL.
4. DIMENSIONS A AND B DO NOT INCLUDE MOLD FLASH, PROTRUSIONS, OR GATE BURRS. MOLD FLASH, PROTRUSIONS, OR GATE BURRS SHALL NOT EXCEED 0.15 PER SIDE. DIMENSION A.
5. OPTIONAL CONSTRUCTION: AN ADDITIONAL TRIMMED LEAD IS ALLOWED IN THIS LOCATION. TRIMMED LEAD NOT TO EXTEND MORE THAN 0.2 FROM BODY.

DIM	MILLIMETERS	
	MIN	MAX
A	2.85	3.15
B	1.35	1.65
C	0.90	1.10
D	0.25	0.50
G	0.95 BSC	
H	0.01	0.10
J	0.10	0.26
K	0.20	0.60
M	0°	10°
S	2.50	3.00

#### SOLDERING FOOTPRINT\*



\*For additional information on our Pb-Free strategy and soldering details, please download the ON Semiconductor Soldering and Mounting Techniques Reference Manual, SOLDERRM/D.

#### GENERIC MARKING DIAGRAM\*



- XXX = Specific Device Code
- A = Assembly Location
- Y = Year
- W = Work Week
- = Pb-Free Package
- XXX = Specific Device Code
- M = Date Code
- = Pb-Free Package

(Note: Microdot may be in either location)

\*This information is generic. Please refer to device data sheet for actual part marking. Pb-Free indicator, "G" or microdot "■", may or may not be present.

<b>DOCUMENT NUMBER:</b>	<b>98ARB18753C</b>	Electronic versions are uncontrolled except when accessed directly from the Document Repository. Printed versions are uncontrolled except when stamped "CONTROLLED COPY" in red.
<b>DESCRIPTION:</b>	<b>TSOP-5</b>	<b>PAGE 1 OF 1</b>

ON Semiconductor and ON are trademarks of Semiconductor Components Industries, LLC dba ON Semiconductor or its subsidiaries in the United States and/or other countries. ON Semiconductor reserves the right to make changes without further notice to any products herein. ON Semiconductor makes no warranty, representation or guarantee regarding the suitability of its products for any particular purpose, nor does ON Semiconductor assume any liability arising out of the application or use of any product or circuit, and specifically disclaims any and all liability, including without limitation special, consequential or incidental damages. ON Semiconductor does not convey any license under its patent rights nor the rights of others.

# MECHANICAL CASE OUTLINE

## PACKAGE DIMENSIONS

ON Semiconductor®



SCALE 4:1

XDFN6 1.5x1.5, 0.5P  
CASE 711AE  
ISSUE B

DATE 27 AUG 2015

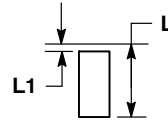
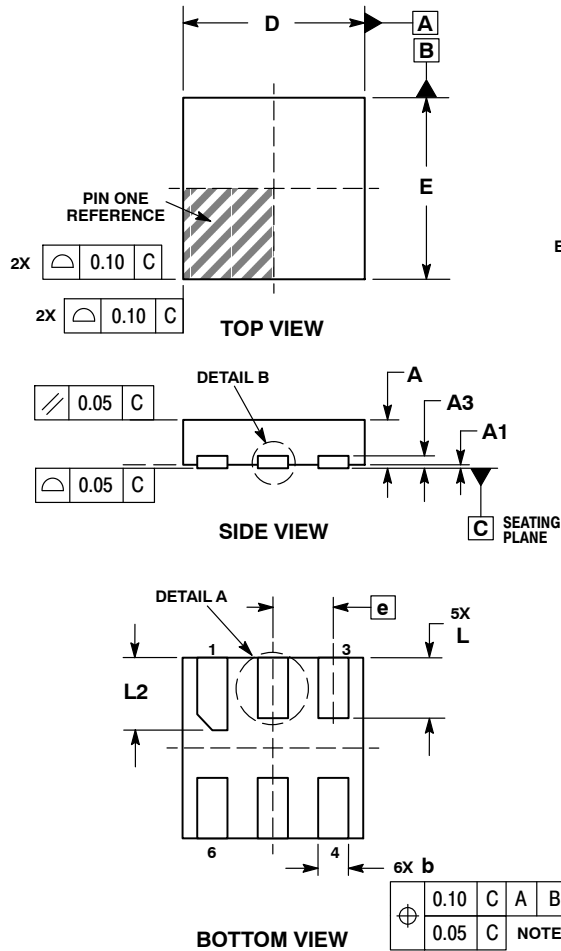

**DETAIL A**  
ALTERNATE TERMINAL  
CONSTRUCTIONS

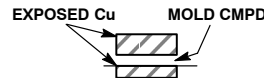

**DETAIL B**  
ALTERNATE  
CONSTRUCTIONS

- NOTES:
- DIMENSIONING AND TOLERANCING PER ASME Y14.5M, 1994.
  - CONTROLLING DIMENSION: MILLIMETERS.
  - DIMENSION b APPLIES TO PLATED TERMINAL AND IS MEASURED BETWEEN 0.10 AND 0.20mm FROM TERMINAL TIP.

DIM	MILLIMETERS	
	MIN	MAX
A	0.35	0.45
A1	0.00	0.05
A3	0.13 REF	
b	0.20	0.30
D	1.50 BSC	
E	1.50 BSC	
e	0.50 BSC	
L	0.40	0.60
L1	---	0.15
L2	0.50	0.70

### GENERIC MARKING DIAGRAM\*

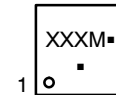

XXX = Specific Device Code

M = Date Code

▪ = Pb-Free Package

(Note: Microdot may be in either location)

\*This information is generic. Please refer to device data sheet for actual part marking. Pb-Free indicator, "G" or microdot "▪", may or may not be present.

### RECOMMENDED MOUNTING FOOTPRINT\*

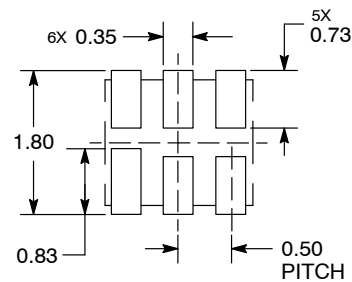

DIMENSIONS: MILLIMETERS

\*For additional information on our Pb-Free strategy and soldering details, please download the ON Semiconductor Soldering and Mounting Techniques Reference Manual, SOLDERRM/D.

<b>DOCUMENT NUMBER:</b>	<b>98AON56376E</b>	Electronic versions are uncontrolled except when accessed directly from the Document Repository. Printed versions are uncontrolled except when stamped "CONTROLLED COPY" in red.
<b>DESCRIPTION:</b>	<b>XDFN6, 1.5 X 1.5, 0.5 P</b>	<b>PAGE 1 OF 1</b>

ON Semiconductor and are trademarks of Semiconductor Components Industries, LLC dba ON Semiconductor or its subsidiaries in the United States and/or other countries. ON Semiconductor reserves the right to make changes without further notice to any products herein. ON Semiconductor makes no warranty, representation or guarantee regarding the suitability of its products for any particular purpose, nor does ON Semiconductor assume any liability arising out of the application or use of any product or circuit, and specifically disclaims any and all liability, including without limitation special, consequential or incidental damages. ON Semiconductor does not convey any license under its patent rights nor the rights of others.

**onsemi**, **Onsemi**, and other names, marks, and brands are registered and/or common law trademarks of Semiconductor Components Industries, LLC dba "**onsemi**" or its affiliates and/or subsidiaries in the United States and/or other countries. **onsemi** owns the rights to a number of patents, trademarks, copyrights, trade secrets, and other intellectual property. A listing of **onsemi**'s product/patent coverage may be accessed at [www.onsemi.com/site/pdf/Patent-Marking.pdf](http://www.onsemi.com/site/pdf/Patent-Marking.pdf). **onsemi** reserves the right to make changes at any time to any products or information herein, without notice. The information herein is provided "as-is" and **onsemi** makes no warranty, representation or guarantee regarding the accuracy of the information, product features, availability, functionality, or suitability of its products for any particular purpose, nor does **onsemi** assume any liability arising out of the application or use of any product or circuit, and specifically disclaims any and all liability, including without limitation special, consequential or incidental damages. Buyer is responsible for its products and applications using **onsemi** products, including compliance with all laws, regulations and safety requirements or standards, regardless of any support or applications information provided by **onsemi**. "Typical" parameters which may be provided in **onsemi** data sheets and/or specifications can and do vary in different applications and actual performance may vary over time. All operating parameters, including "Typicals" must be validated for each customer application by customer's technical experts. **onsemi** does not convey any license under any of its intellectual property rights nor the rights of others. **onsemi** products are not designed, intended, or authorized for use as a critical component in life support systems or any FDA Class 3 medical devices or medical devices with a same or similar classification in a foreign jurisdiction or any devices intended for implantation in the human body. Should Buyer purchase or use **onsemi** products for any such unintended or unauthorized application, Buyer shall indemnify and hold **onsemi** and its officers, employees, subsidiaries, affiliates, and distributors harmless against all claims, costs, damages, and expenses, and reasonable attorney fees arising out of, directly or indirectly, any claim of personal injury or death associated with such unintended or unauthorized use, even if such claim alleges that **onsemi** was negligent regarding the design or manufacture of the part. **onsemi** is an Equal Opportunity/Affirmative Action Employer. This literature is subject to all applicable copyright laws and is not for resale in any manner.

## PUBLICATION ORDERING INFORMATION

### LITERATURE FULFILLMENT:

Email Requests to: [orderlit@onsemi.com](mailto:orderlit@onsemi.com)

**onsemi Website:** [www.onsemi.com](http://www.onsemi.com)

### TECHNICAL SUPPORT

**North American Technical Support:**  
Voice Mail: 1 800-282-9855 Toll Free USA/Canada  
Phone: 011 421 33 790 2910

**Europe, Middle East and Africa Technical Support:**

Phone: 00421 33 790 2910

For additional information, please contact your local Sales Representative