

# ON Semiconductor

## Is Now

# onsemi™

To learn more about onsemi™, please visit our website at  
[www.onsemi.com](http://www.onsemi.com)

---

**onsemi** and **onsemi** and other names, marks, and brands are registered and/or common law trademarks of Semiconductor Components Industries, LLC dba "**onsemi**" or its affiliates and/or subsidiaries in the United States and/or other countries. **onsemi** owns the rights to a number of patents, trademarks, copyrights, trade secrets, and other intellectual property. A listing of **onsemi** product/patent coverage may be accessed at [www.onsemi.com/site/pdf/Patent-Marking.pdf](http://www.onsemi.com/site/pdf/Patent-Marking.pdf). **onsemi** reserves the right to make changes at any time to any products or information herein, without notice. The information herein is provided "as-is" and **onsemi** makes no warranty, representation or guarantee regarding the accuracy of the information, product features, availability, functionality, or suitability of its products for any particular purpose, nor does **onsemi** assume any liability arising out of the application or use of any product or circuit, and specifically disclaims any and all liability, including without limitation special, consequential or incidental damages. Buyer is responsible for its products and applications using **onsemi** products, including compliance with all laws, regulations and safety requirements or standards, regardless of any support or applications information provided by **onsemi**. "Typical" parameters which may be provided in **onsemi** data sheets and/or specifications can and do vary in different applications and actual performance may vary over time. All operating parameters, including "Typicals" must be validated for each customer application by customer's technical experts. **onsemi** does not convey any license under any of its intellectual property rights nor the rights of others. **onsemi** products are not designed, intended, or authorized for use as a critical component in life support systems or any FDA Class 3 medical devices or medical devices with a same or similar classification in a foreign jurisdiction or any devices intended for implantation in the human body. Should Buyer purchase or use **onsemi** products for any such unintended or unauthorized application, Buyer shall indemnify and hold **onsemi** and its officers, employees, subsidiaries, affiliates, and distributors harmless against all claims, costs, damages, and expenses, and reasonable attorney fees arising out of, directly or indirectly, any claim of personal injury or death associated with such unintended or unauthorized use, even if such claim alleges that **onsemi** was negligent regarding the design or manufacture of the part. **onsemi** is an Equal Opportunity/Affirmative Action Employer. This literature is subject to all applicable copyright laws and is not for resale in any manner. Other names and brands may be claimed as the property of others.

# TVS8814, TVS8818

## Transient Voltage Suppressors

### Low Capacitance TVS Protection for High Speed Data

The TVS8814 and TVS8818 transient voltage suppressors are designed specifically to protect 10/100 and GbE Ethernet signals from high levels of surge current. Low clamping voltage under high surge conditions make this device an ideal solution for protecting voltage sensitive lines leading to Ethernet transceiver chips. Low capacitance combined with flow-through style packaging allows for easy PCB layout and matched trace lengths necessary to maintain consistent impedance between high-speed differential lines. The integrated 4 and 8 lines of protection in flow-thru type packages offer a simplified solution with premier performance for 10/100 and GbE Ethernet applications.

#### Features

- Protection for the Following IEC Standards:  
IEC 61000-4-2 (ESD)  $\pm 30$  kV (Contact)  
IEC61000-4-5 (Lightning) 35 A (8/20  $\mu$ s)
- Flow-Thru Routing Scheme
- 2 pF Max, I/O to I/O
- UL Flammability Rating of 94 V-0
- This is a Pb-Free Device

#### Typical Applications

- 10/100 and GbE Ethernet
- MagJacks® / Integrated Magnetics
- Notebooks/Desktops/Servers

#### MAXIMUM RATINGS ( $T_J = 25^\circ\text{C}$ unless otherwise noted)

Rating	Symbol	Value	Unit
Operating Junction Temperature Range	$T_J$	-55 to +125	$^\circ\text{C}$
Storage Temperature Range	$T_{stg}$	-55 to +150	$^\circ\text{C}$
Lead Solder Temperature – Maximum (10 Seconds)	$T_L$	260	$^\circ\text{C}$
IEC 61000-4-2 Contact (ESD) IEC 61000-4-2 Air (ESD)	ESD	$\pm 30$ $\pm 30$	kV kV
Maximum Peak Pulse Current 8/20 $\mu$ s @ $T_A = 25^\circ\text{C}$ 10/700 $\mu$ s @ $T_A = 25^\circ\text{C}$	$I_{PP}$	35 20	A

Stresses exceeding those listed in the Maximum Ratings table may damage the device. If any of these limits are exceeded, device functionality should not be assumed, damage may occur and reliability may be affected.

See Application Note AND8308/D for further description of survivability specs.



ON Semiconductor®

[www.onsemi.com](http://www.onsemi.com)

#### MARKING DIAGRAMS

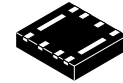

UDFN8  
CASE 506CV

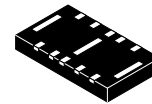

UDFN10  
CASE 506CU

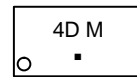

- XX = Specific Device Code
- M = Date Code
- = Pb-Free Package

#### ORDERING INFORMATION

Device	Package	Shipping
TVS8814MUTAG	UDFN8 (Pb-Free)	3000 / Tape & Reel
TVS8818MUTAG	UDFN10 (Pb-Free)	3000 / Tape & Reel

†For information on tape and reel specifications, including part orientation and tape sizes, please refer to our Tape and Reel Packaging Specification Brochure, BRD8011/D.

# TVS8814, TVS8818

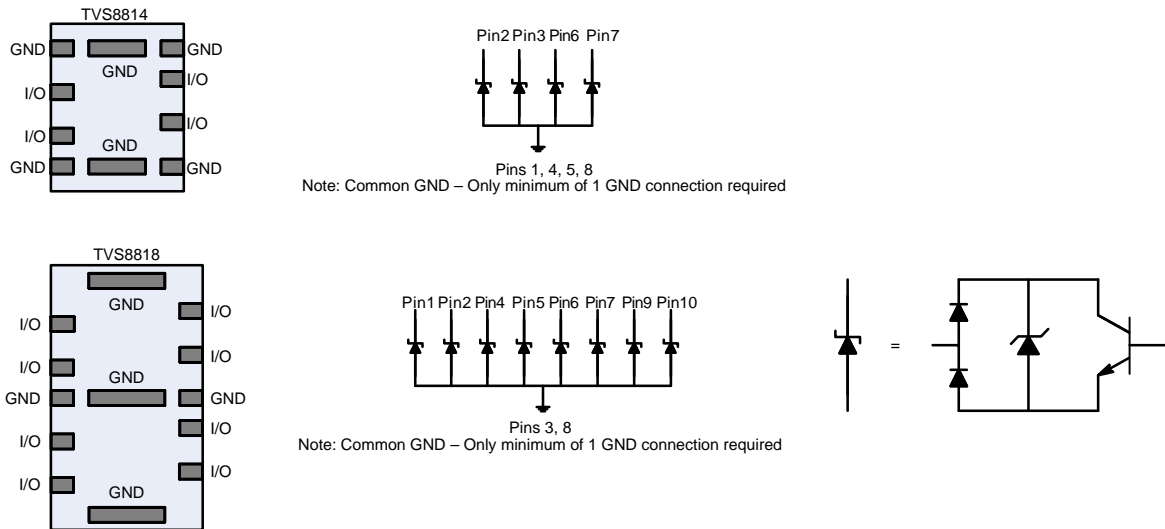
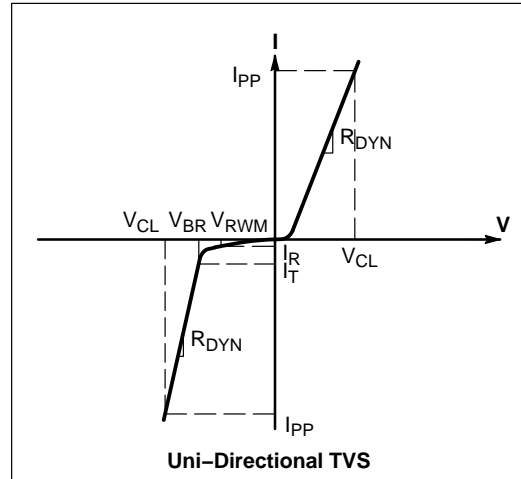

Figure 1. Pin Schematic

## ELECTRICAL CHARACTERISTICS

( $T_A = 25^\circ\text{C}$  unless otherwise noted)

Symbol	Parameter
$V_{RWM}$	Working Peak Voltage
$I_R$	Maximum Reverse Leakage Current @ $V_{RWM}$
$V_{BR}$	Breakdown Voltage @ $I_T$
$I_T$	Test Current
$V_{HOLD}$	Holding Reverse Voltage
$I_{HOLD}$	Holding Reverse Current
$R_{DYN}$	Dynamic Resistance
$I_{PP}$	Maximum Peak Pulse Current
$V_C$	Clamping Voltage @ $I_{PP}$ $V_C = V_{HOLD} + (I_{PP} * R_{DYN})$



## ELECTRICAL CHARACTERISTICS ( $T_A = 25^\circ\text{C}$ unless otherwise specified)

Parameter	Symbol	Conditions	Min	Typ	Max	Unit
Reverse Working Voltage	$V_{RWM}$	Any I/O to GND (Note 1)			3.0	V
Forward Voltage	$V_F$	$I_F = 10\text{ mA}$ , GND to All IO Pins	0.5	0.85	1.1	V
Breakdown Voltage	$V_{BR}$	$I_T = 1\text{ mA}$ , I/O to GND	3.2	3.5	5.0	V
Reverse Leakage Current	$I_R$	$V_{RWM} = 3.0\text{ V}$ , I/O to GND			0.5	$\mu\text{A}$
Clamping Voltage	$V_C$	$I_{PP} = 1\text{ A}$ , Any I/O to GND (8/20 $\mu\text{s}$ pulse)			5.0	V
Clamping Voltage	$V_C$	$I_{PP} = 10\text{ A}$ , Any I/O to GND (8/20 $\mu\text{s}$ pulse)			6.0	V
Clamping Voltage	$V_C$	$I_{PP} = 25\text{ A}$ , Any I/O to GND (8/20 $\mu\text{s}$ pulse)			10	V
Clamping Voltage	$V_C$	$I_{PP} = 35\text{ A}$ , Any I/O to GND (8/20 $\mu\text{s}$ pulse)			15	V
Clamping Voltage	$V_C$	IEC61000-4-2, $\pm 8\text{ kV}$ Contact	See Figures 7 and 8			V
Junction Capacitance	$C_J$	$V_R = 0\text{ V}$ , $f = 1\text{ MHz}$ between I/O Pins		1.5	2.0	pF
Junction Capacitance	$C_J$	$V_R = 0\text{ V}$ , $f = 1\text{ MHz}$ between I/O Pins and GND			5.0	pF

Product parametric performance is indicated in the Electrical Characteristics for the listed test conditions, unless otherwise noted. Product performance may not be indicated by the Electrical Characteristics if operated under different conditions.

- TVS devices are normally selected according to the working peak reverse voltage ( $V_{RWM}$ ), which should be equal or greater than the DC or continuous peak operating voltage level.

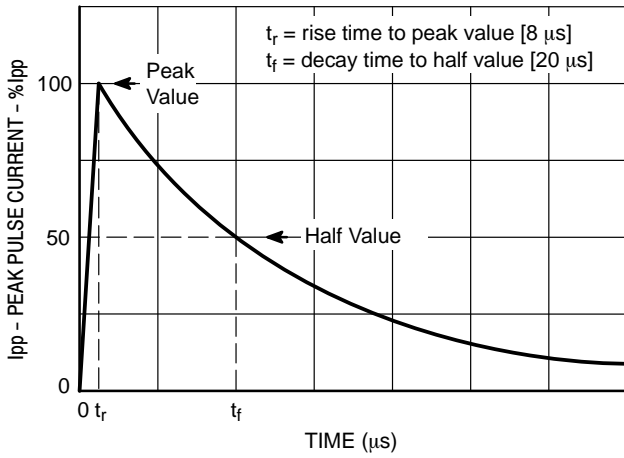

Figure 2. IEC61000-4-5 8/20  $\mu$ s Pulse Waveform

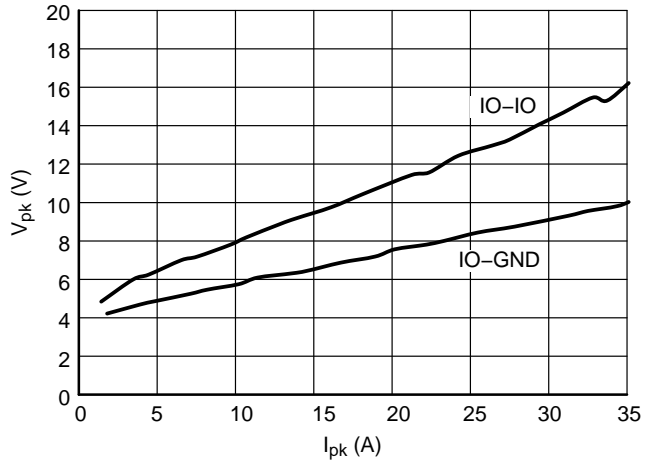

Figure 3. Clamping Voltage vs. Peak Pulse Current ( $t_p = 8/20 \mu$ s per Figure 2)

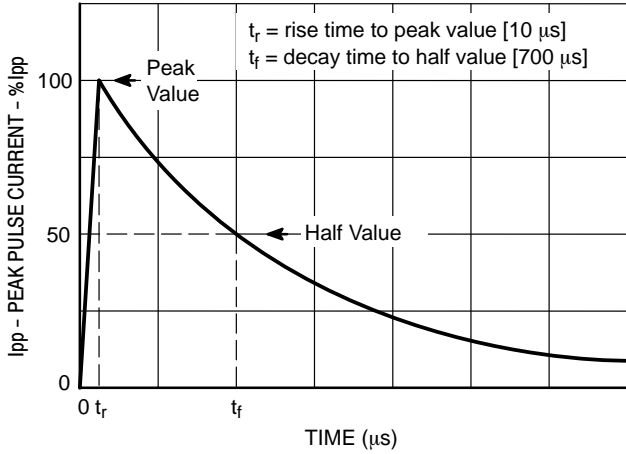

Figure 4. IEC61000-4-5 10/700  $\mu$ s Pulse Waveform

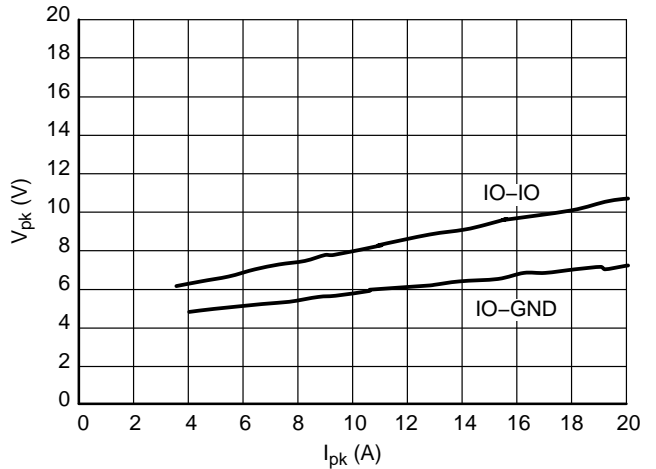

Figure 5. Clamping Voltage vs. Peak Pulse Current ( $t_p = 10/700 \mu$ s per Figure 4)

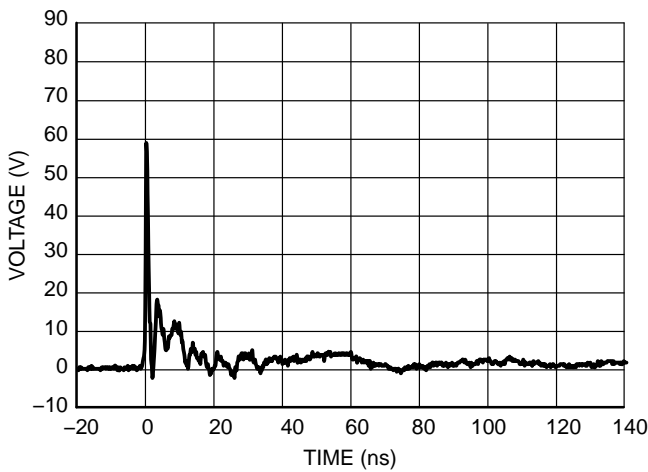

Figure 6. IEC61000-2-4 +8 kV Contact Clamping Voltage

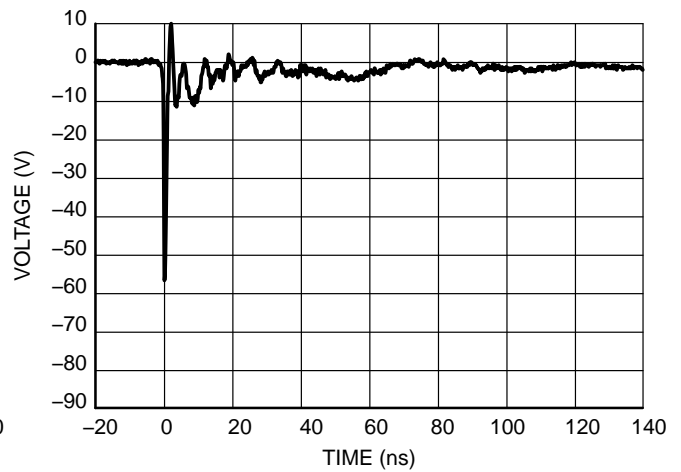

Figure 7. IEC61000-2-4 -8 kV Contact Clamping Voltage

# TVS8814, TVS8818

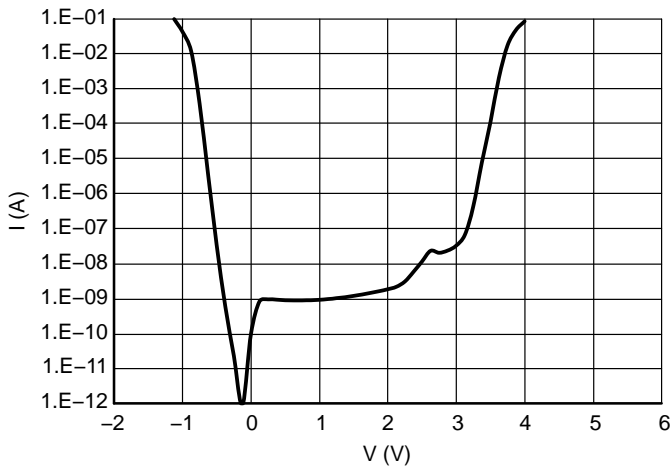

Figure 8. IV Characteristics

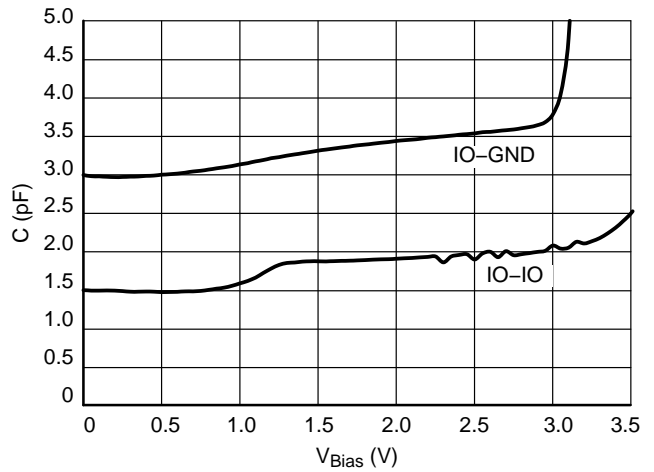

Figure 9. CV Characteristics

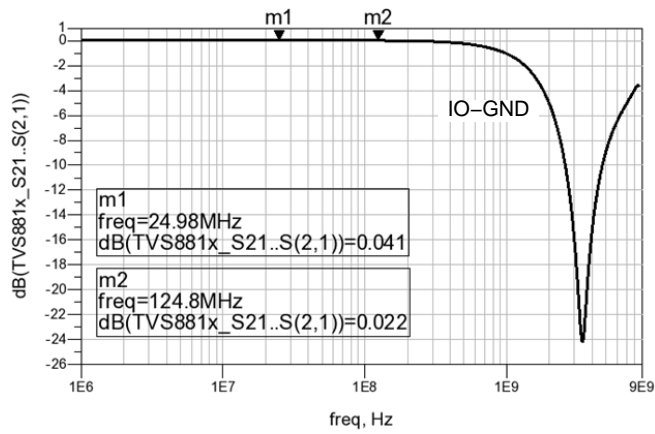

Figure 10. RF Insertion Loss

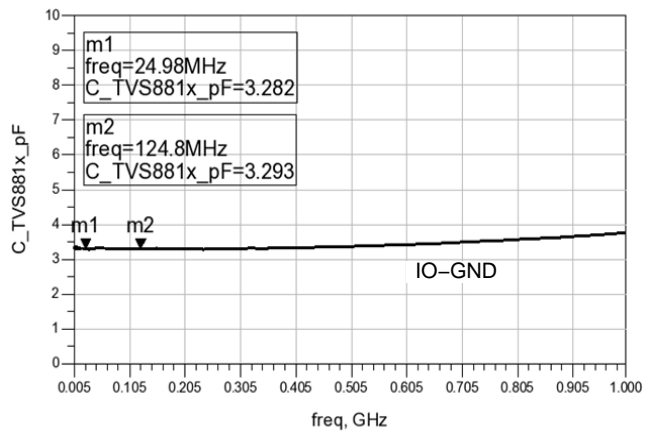

Figure 11. Capacitance Over Frequency

# TVS8814, TVS8818

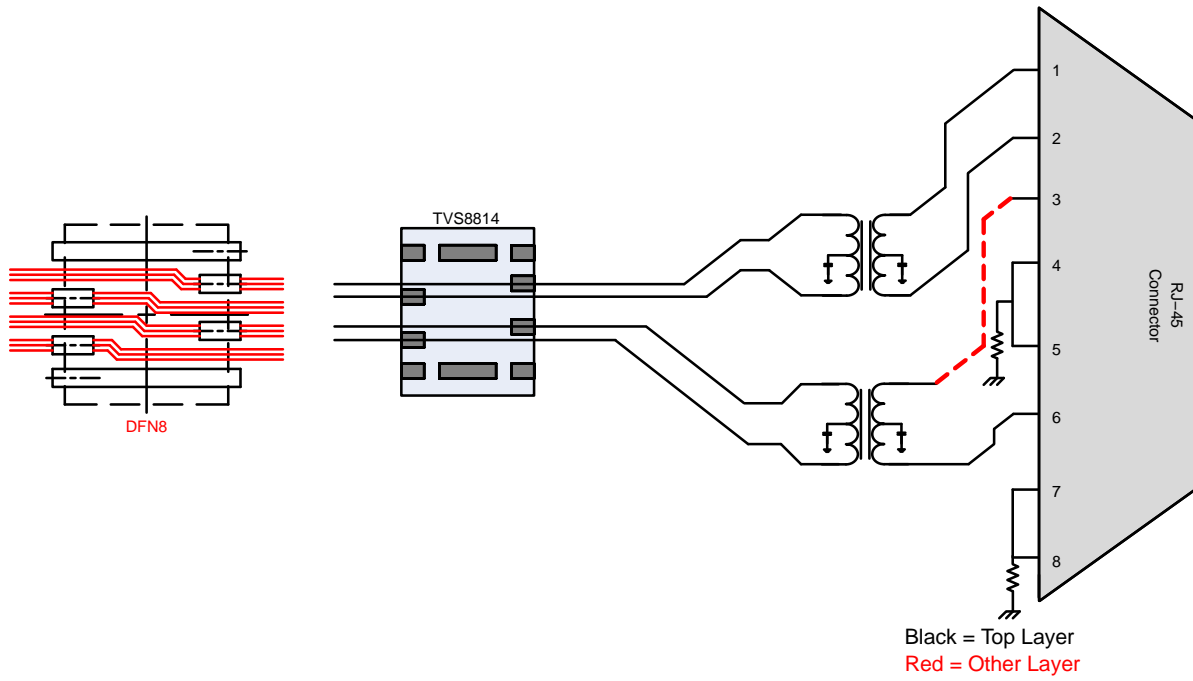

Figure 12. 10/100 Ethernet Layout Diagram and Flow-thru Routing Scheme

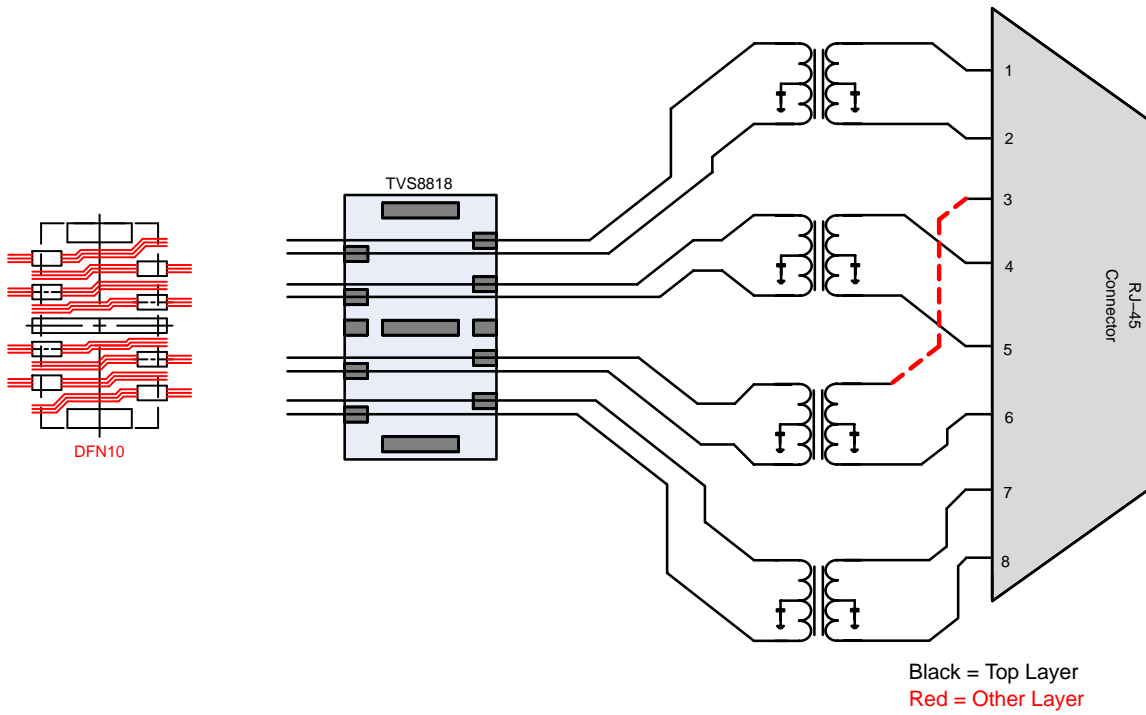
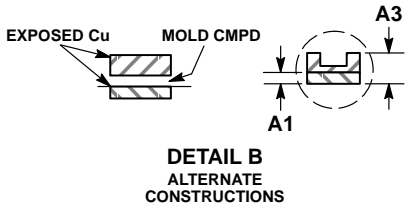
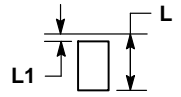
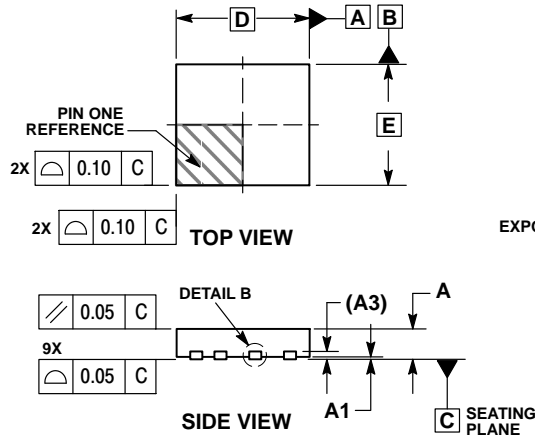

Figure 13. GbE Ethernet Layout Diagram and Flow-thru Routing Scheme

# TVS8814, TVS8818

## PACKAGE DIMENSIONS

UDFN8 2.2x2, 0.575P  
CASE 506CV  
ISSUE A



- NOTES:
1. DIMENSIONING AND TOLERANCING PER ASME Y14.5M, 1994.
  2. CONTROLLING DIMENSION: MILLIMETERS.
  3. DIMENSIONS b APPLIES TO PLATED TERMINAL AND IS MEASURED BETWEEN 0.15 AND 0.25 MM FROM TERMINAL TIP.

DIM	MILLIMETERS	
	MIN	MAX
A	0.45	0.55
A1	0.00	0.05
A3	0.127 REF	
b	0.15	0.25
D	2.20 BSC	
E	2.00 BSC	
E3	0.20 BSC	
e	0.575 BSC	
e2	0.40 BSC	
L	0.25	0.35
L1	0.05	0.15
L2	0.95	1.05

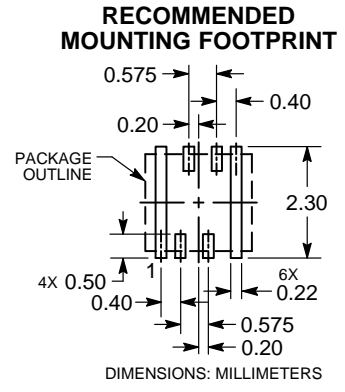
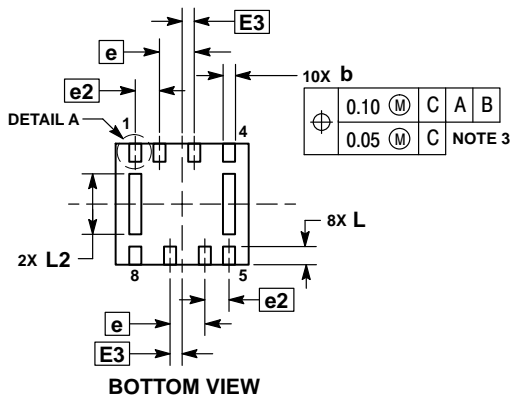

\*For additional information on our Pb-Free strategy and soldering details, please download the ON Semiconductor Soldering and Mounting Techniques Reference Manual, SOLDERRM/D.

# TVS8814, TVS8818

## PACKAGE DIMENSIONS

UDFN10 3.5x2, 0.575P  
CASE 506CU  
ISSUE O

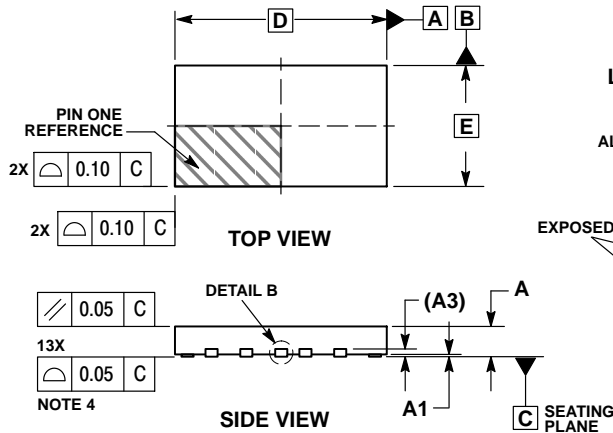

**NOTES:**

1. DIMENSIONING AND TOLERANCING PER ASME Y14.5M, 1994.
2. CONTROLLING DIMENSION: MILLIMETERS.
3. DIMENSIONS b APPLIES TO PLATED TERMINAL AND IS MEASURED BETWEEN 0.15 AND 0.25 MM FROM TERMINAL TIP.
4. COPLANARITY APPLIES TO THE EXPOSED PAD AS WELL AS THE TERMINALS.

DIM	MILLIMETERS	
	MIN	MAX
A	0.45	0.55
A1	0.00	0.05
A3	0.127 REF	
b	0.15	0.25
D	3.50 BSC	
E	2.00 BSC	
e	0.575 BSC	
e2	0.40 BSC	
e3	3.10 BSC	
L	0.25	0.35
L1	0.05	0.15
L2	0.95	1.05

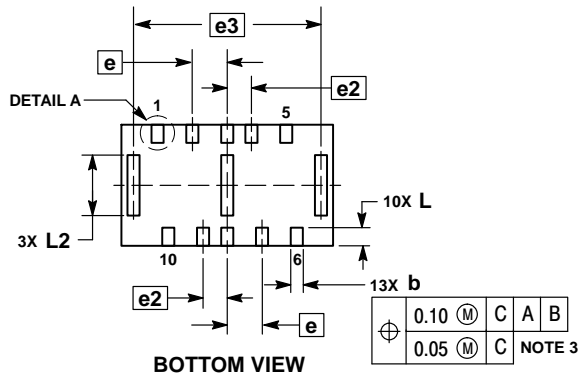

**RECOMMENDED MOUNTING FOOTPRINT\***

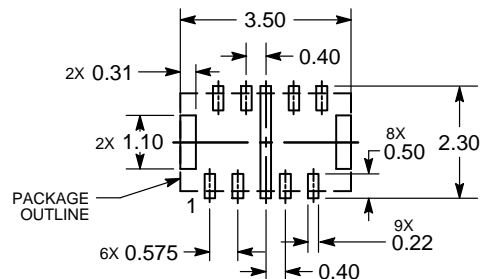

\*For additional information on our Pb-Free strategy and soldering details, please download the ON Semiconductor Soldering and Mounting Techniques Reference Manual, SOLDERRM/D.

MagJack is a trademark of Bel Fuse Inc.

ON Semiconductor and the are registered trademarks of Semiconductor Components Industries, LLC (SCILLC) or its subsidiaries in the United States and/or other countries. SCILLC owns the rights to a number of patents, trademarks, copyrights, trade secrets, and other intellectual property. A listing of SCILLC's product/patent coverage may be accessed at [www.onsemi.com/site/pdf/Patent-Marking.pdf](http://www.onsemi.com/site/pdf/Patent-Marking.pdf). SCILLC reserves the right to make changes without further notice to any products herein. SCILLC makes no warranty, representation or guarantee regarding the suitability of its products for any particular purpose, nor does SCILLC assume any liability arising out of the application or use of any product or circuit, and specifically disclaims any and all liability, including without limitation special, consequential or incidental damages. "Typical" parameters which may be provided in SCILLC data sheets and/or specifications can and do vary in different applications and actual performance may vary over time. All operating parameters, including "Typicals" must be validated for each customer application by customer's technical experts. SCILLC does not convey any license under its patent rights nor the rights of others. SCILLC products are not designed, intended, or authorized for use as components in systems intended for surgical implant into the body, or other applications intended to support or sustain life, or for any other application in which the failure of the SCILLC product could create a situation where personal injury or death may occur. Should Buyer purchase or use SCILLC products for any such unintended or unauthorized application, Buyer shall indemnify and hold SCILLC and its officers, employees, subsidiaries, affiliates, and distributors harmless against all claims, costs, damages, and expenses, and reasonable attorney fees arising out of, directly or indirectly, any claim of personal injury or death associated with such unintended or unauthorized use, even if such claim alleges that SCILLC was negligent regarding the design or manufacture of the part. SCILLC is an Equal Opportunity/Affirmative Action Employer. This literature is subject to all applicable copyright laws and is not for resale in any manner.

**PUBLICATION ORDERING INFORMATION**

**LITERATURE FULFILLMENT:**  
Literature Distribution Center for ON Semiconductor  
19521 E. 32nd Pkwy, Aurora, Colorado 80011 USA  
Phone: 303-675-2175 or 800-344-3860 Toll Free USA/Canada  
Fax: 303-675-2176 or 800-344-3867 Toll Free USA/Canada  
Email: [orderlit@onsemi.com](mailto:orderlit@onsemi.com)

**N. American Technical Support:** 800-282-9855 Toll Free USA/Canada  
**Europe, Middle East and Africa Technical Support:** Phone: 421 33 790 2910  
**Japan Customer Focus Center** Phone: 81-3-5817-1050

**ON Semiconductor Website:** [www.onsemi.com](http://www.onsemi.com)  
**Order Literature:** <http://www.onsemi.com/orderlit>  
For additional information, please contact your local Sales Representative