

PNP Epitaxial Silicon Transistor

KSA1015

Features

- Low-Frequency Amplifier
- Collector-Base Voltage: $V_{CB0} = -50\text{ V}$
- Complement to KSC1815
- These Devices are Pb-Free, Halogen Free/BFR Free and are RoHS Compliant

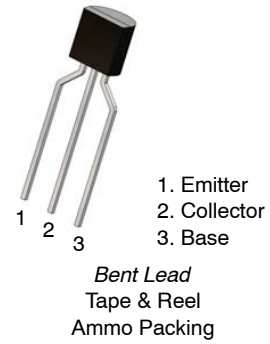

TO-92 3 4.83x4.76 LEADFORMED
CASE 135AR

ABSOLUTE MAXIMUM RATINGS ($T_A = 25^\circ\text{C}$ unless otherwise noted)

Symbol	Parameter	Value	Unit
V_{CB0}	Collector-Base Voltage	-50	V
V_{CEO}	Collector-Emitter Voltage	-50	V
V_{EBO}	Emitter-Base Voltage	-5	V
I_C	Collector Current	-150	mA
I_B	Base Current	-50	mA
T_J	Junction Temperature	150	$^\circ\text{C}$
T_{STG}	Storage Temperature Range	-55 to 150	$^\circ\text{C}$

Stresses exceeding those listed in the Maximum Ratings table may damage the device. If any of these limits are exceeded, device functionality should not be assumed, damage may occur and reliability may be affected.

THERMAL CHARACTERISTICS (Note 1)

($T_A = 25^\circ\text{C}$ unless otherwise noted)

Symbol	Parameter	Max	Unit
P_D	Total Device Dissipation	400	mW
	Derate Above 25°C	3.2	mW/ $^\circ\text{C}$
$R_{\theta JA}$	Thermal Resistance, Junction to Ambient	312	$^\circ\text{C}/\text{W}$

1. PCB size: FR-4, 76 mm x 114 mm x 1.57 mm (3.0 inch x 4.5 inch x 0.062 inch) with minimum land pattern size.

MARKING DIAGRAM

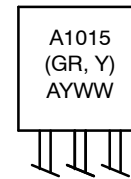

A = Assembly Site
A1015(GR, Y) = Device Code
Y = Year of Production,
WW = Work Week Number

ORDERING INFORMATION

Device	Marking	Package	Packing Method
KSA1015GRTA	A1015GR	TO-92 3L (Pb-Free)	Ammo
KSA1015YTA	A1015Y	TO-92 3L (Pb-Free)	Ammo

KSA1015

ELECTRICAL CHARACTERISTICS ($T_A = 25^\circ\text{C}$ unless otherwise noted)

Symbol	Parameter	Conditions	Min	Typ	Max	Unit
BV_{CBO}	Collector-Base Breakdown Voltage	$I_C = -100 \mu\text{A}, I_E = 0$	-50	-	-	V
BV_{CEO}	Collector-Emitter Breakdown Voltage	$I_C = -10 \text{ mA}, I_B = 0$	-50	-	-	V
BV_{EBO}	Emitter-Base Breakdown Voltage	$I_E = -10 \mu\text{A}, I_C = 0$	-5	-	-	V
I_{CBO}	Collector Cut-Off Current	$V_{CB} = -50 \text{ V}, I_E = 0$	-	-	-0.1	μA
I_{EBO}	Emitter Cut-Off Current	$V_{EB} = -5 \text{ V}, I_C = 0$	-	-	-0.1	μA
h_{FE1}	DC Current Gain	$V_{CE} = -6 \text{ V}, I_C = -2 \text{ mA}$	70	-	400	
h_{FE2}	DC Current Gain	$V_{CE} = -6 \text{ V}, I_C = -150 \text{ mA}$	25	-	-	
$V_{CE(sat)}$	Collector-Emitter Saturation Voltage	$I_C = -100 \text{ mA}, I_B = -10 \text{ mA}$	-	-0.1	-0.3	V
$V_{BE(sat)}$	Base-Emitter Saturation Voltage	$I_C = -100 \text{ mA}, I_B = -10 \text{ mA}$	-	-	-1.1	V
f_T	Current Gain Bandwidth Product	$V_{CE} = -10 \text{ V}, I_C = -1 \text{ mA}$	80	-	-	MHz
C_{ob}	Output Capacitance	$V_{CB} = -10 \text{ V}, I_E = 0, f = 1 \text{ MHz}$	-	4	7	pF
NF	Noise Figure	$V_{CE} = -6 \text{ V}, I_C = -0.1 \text{ mA}, f = 100 \text{ Hz}, R_G = 10 \text{ k}\Omega$	-	0.5	6	dB

Product parametric performance is indicated in the Electrical Characteristics for the listed test conditions, unless otherwise noted. Product performance may not be indicated by the Electrical Characteristics if operated under different conditions.

h_{FE} CLASSIFICATION

Classification	O	Y	GR
h_{FE1}	70~140	120~240	200~400

TYPICAL PERFORMANCE CHARACTERISTICS

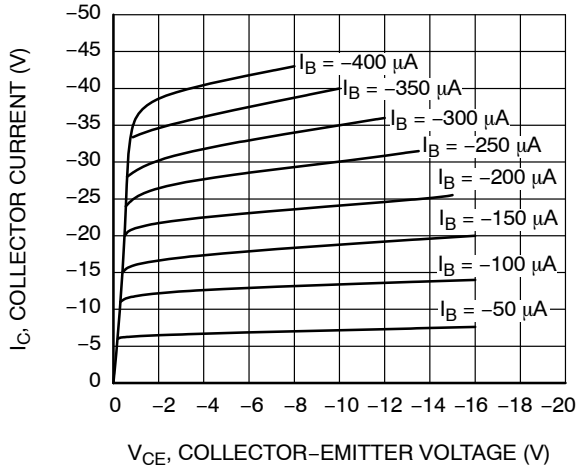

Figure 1. Static Characteristic

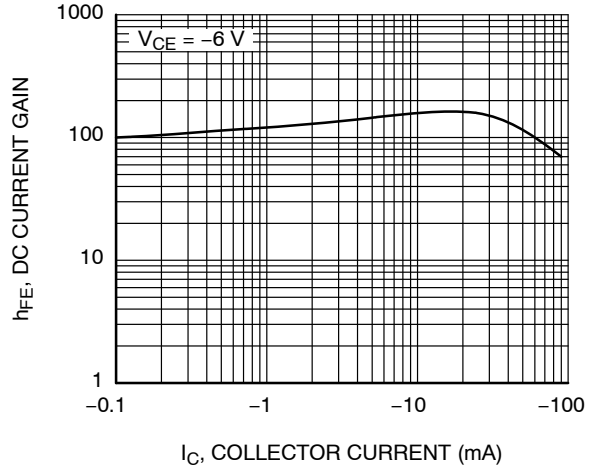

Figure 2. DC Current Gain

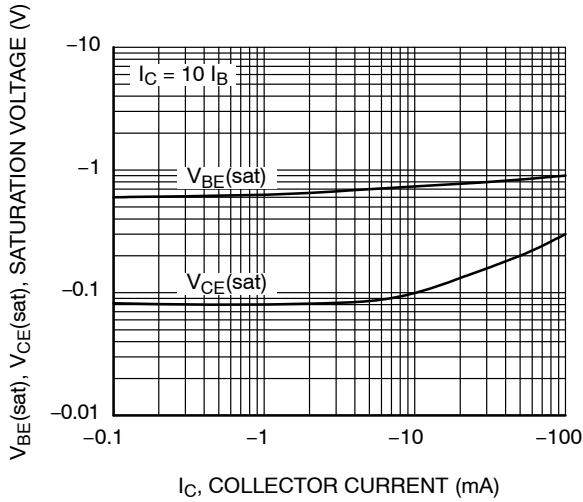

Figure 3. Base-Emitter Saturation Voltage and Collector-Emitter Saturation Voltage

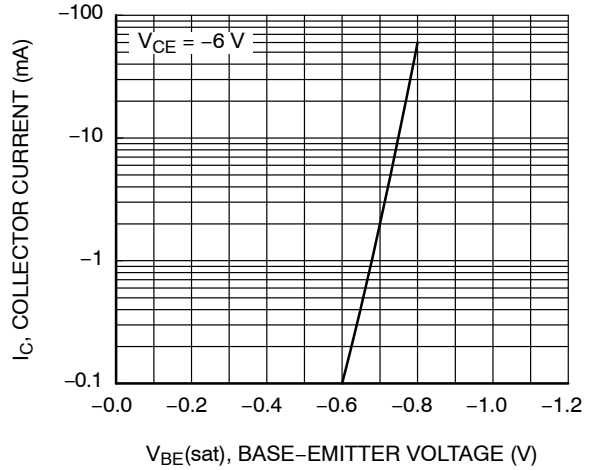

Figure 4. Base-Emitter On Voltage

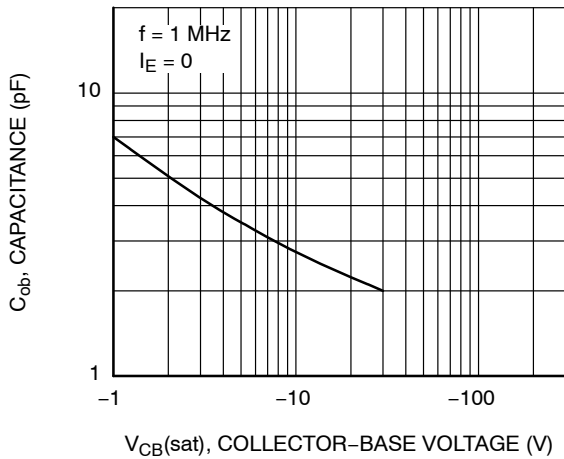

Figure 5. Collector Output Capacitance

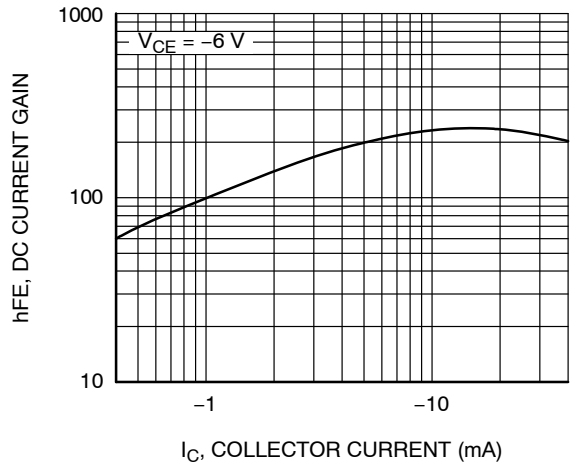
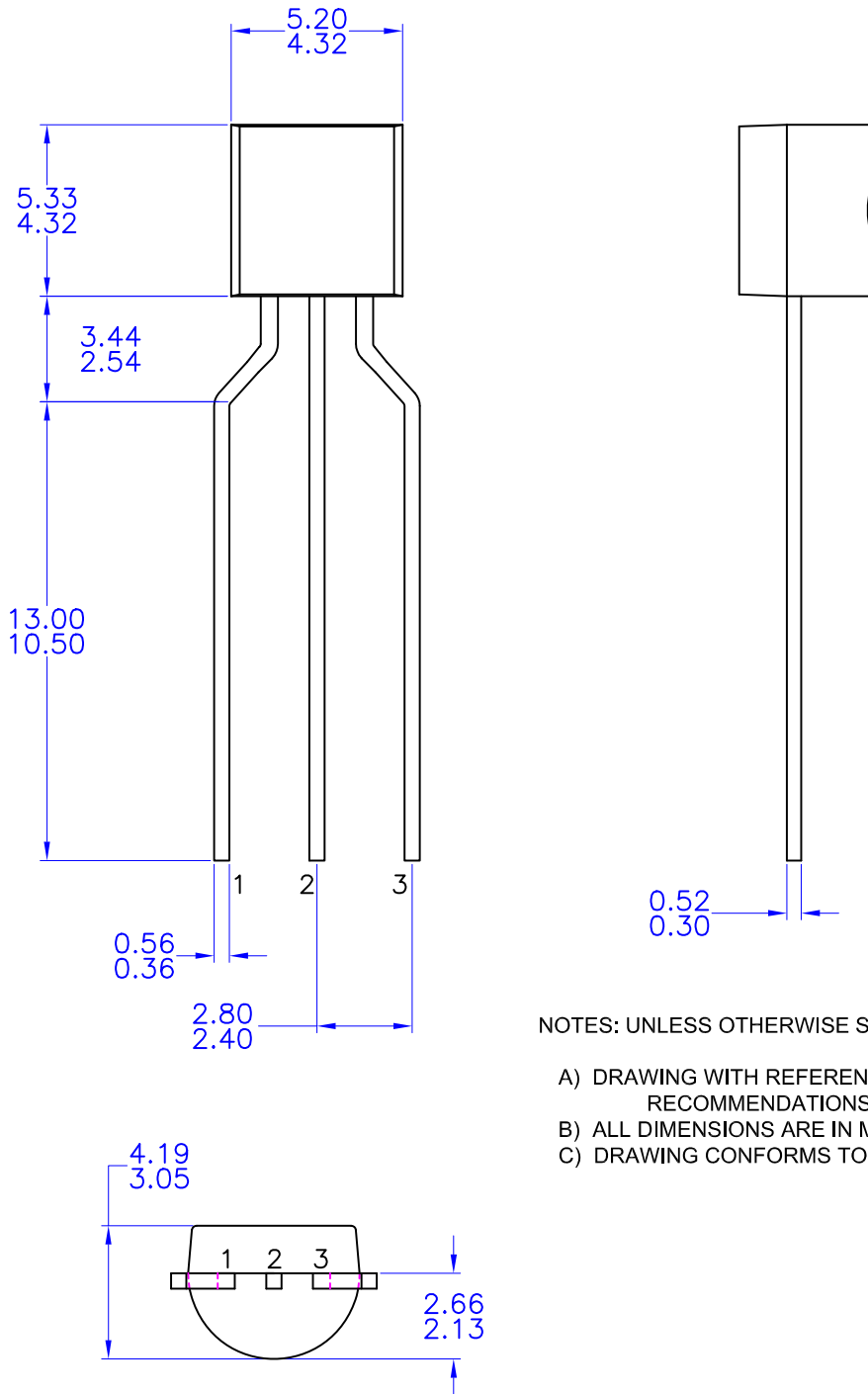

Figure 6. Current Gain Bandwidth Product

TO-92 3 4.83x4.76 LEADFORMED
CASE 135AR
ISSUE O

DATE 30 SEP 2016



NOTES: UNLESS OTHERWISE SPECIFIED

- A) DRAWING WITH REFERENCE TO JEDEC TO-92 RECOMMENDATIONS.
- B) ALL DIMENSIONS ARE IN MILLIMETERS.
- C) DRAWING CONFORMS TO ASME Y14.5M-1994

DOCUMENT NUMBER:	98AON13879G	Electronic versions are uncontrolled except when accessed directly from the Document Repository. Printed versions are uncontrolled except when stamped "CONTROLLED COPY" in red.
DESCRIPTION:	TO-92 3 4.83X4.76 LEADFORMED	PAGE 1 OF 1

ON Semiconductor and  are trademarks of Semiconductor Components Industries, LLC dba ON Semiconductor or its subsidiaries in the United States and/or other countries. ON Semiconductor reserves the right to make changes without further notice to any products herein. ON Semiconductor makes no warranty, representation or guarantee regarding the suitability of its products for any particular purpose, nor does ON Semiconductor assume any liability arising out of the application or use of any product or circuit, and specifically disclaims any and all liability, including without limitation special, consequential or incidental damages. ON Semiconductor does not convey any license under its patent rights nor the rights of others.

onsemi, **Onsemi**, and other names, marks, and brands are registered and/or common law trademarks of Semiconductor Components Industries, LLC dba "**onsemi**" or its affiliates and/or subsidiaries in the United States and/or other countries. **onsemi** owns the rights to a number of patents, trademarks, copyrights, trade secrets, and other intellectual property. A listing of **onsemi**'s product/patent coverage may be accessed at www.onsemi.com/site/pdf/Patent-Marking.pdf. **onsemi** reserves the right to make changes at any time to any products or information herein, without notice. The information herein is provided "as-is" and **onsemi** makes no warranty, representation or guarantee regarding the accuracy of the information, product features, availability, functionality, or suitability of its products for any particular purpose, nor does **onsemi** assume any liability arising out of the application or use of any product or circuit, and specifically disclaims any and all liability, including without limitation special, consequential or incidental damages. Buyer is responsible for its products and applications using **onsemi** products, including compliance with all laws, regulations and safety requirements or standards, regardless of any support or applications information provided by **onsemi**. "Typical" parameters which may be provided in **onsemi** data sheets and/or specifications can and do vary in different applications and actual performance may vary over time. All operating parameters, including "Typicals" must be validated for each customer application by customer's technical experts. **onsemi** does not convey any license under any of its intellectual property rights nor the rights of others. **onsemi** products are not designed, intended, or authorized for use as a critical component in life support systems or any FDA Class 3 medical devices or medical devices with a same or similar classification in a foreign jurisdiction or any devices intended for implantation in the human body. Should Buyer purchase or use **onsemi** products for any such unintended or unauthorized application, Buyer shall indemnify and hold **onsemi** and its officers, employees, subsidiaries, affiliates, and distributors harmless against all claims, costs, damages, and expenses, and reasonable attorney fees arising out of, directly or indirectly, any claim of personal injury or death associated with such unintended or unauthorized use, even if such claim alleges that **onsemi** was negligent regarding the design or manufacture of the part. **onsemi** is an Equal Opportunity/Affirmative Action Employer. This literature is subject to all applicable copyright laws and is not for resale in any manner.

PUBLICATION ORDERING INFORMATION

LITERATURE FULFILLMENT:

Email Requests to: orderlit@onsemi.com

onsemi Website: www.onsemi.com

TECHNICAL SUPPORT

North American Technical Support:

Voice Mail: 1 800-282-9855 Toll Free USA/Canada

Phone: 011 421 33 790 2910

Europe, Middle East and Africa Technical Support:

Phone: 00421 33 790 2910

For additional information, please contact your local Sales Representative