

NTST30U100CT, NTSB30U100CT-1, NTSJ30U100CTG, NTSB30U100CTG



ON Semiconductor®

www.onsemi.com

Very Low Forward Voltage Trench-based Schottky Rectifier

Exceptionally Low $V_F = 0.42\text{ V}$ at $I_F = 5\text{ A}$

Features

- Fine Lithography Trench-based Schottky Technology for Very Low Forward Voltage and Low Leakage
- Fast Switching with Exceptional Temperature Stability
- Low Power Loss and Lower Operating Temperature
- Higher Efficiency for Achieving Regulatory Compliance
- Low Thermal Resistance
- High Surge Capability
- Pb-Free and Halide-Free Packages are Available

Typical Applications

- Switching Power Supplies including Notebook / Netbook Adapters, ATX and Flat Panel Display
- High Frequency and DC-DC Converters
- Freewheeling and OR-ing diodes
- Reverse Battery Protection
- Instrumentation

Mechanical Characteristics

- Case: Epoxy, Molded
- Epoxy Meets Flammability Rating UL 94-0 @ 0.125 in
- Finish: All External Surfaces Corrosion Resistant and Terminal Leads are Readily Solderable
- Lead Temperature for Soldering Purposes: 260°C Maximum for 10 sec

VERY LOW FORWARD VOLT-
AGE, LOW LEAKAGE SCHOT-
TKY BARRIER
RECTIFIERS 30 AMPERES,
100 VOLTS

PIN CONNECTIONS

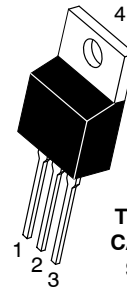
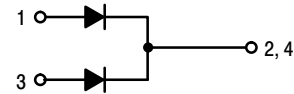

TO-220AB
CASE 221A
STYLE 6

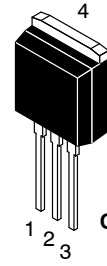

I2PAK
CASE 418D
STYLE 3

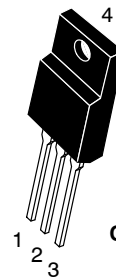

TO-220FP
CASE 221AH

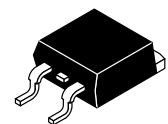

D2PAK
CASE 418B

ORDERING INFORMATION

See detailed ordering and shipping information on page 5 of this data sheet.

NTST30U100CT, NTSB30U100CT-1, NTSJ30U100CTG, NTSB30U100CTG

MAXIMUM RATINGS

Rating	Symbol	Value	Unit
Peak Repetitive Reverse Voltage Working Peak Reverse Voltage DC Blocking Voltage	V_{RRM} V_{RWM} V_R	100	V
Average Rectified Forward Current (Rated V_R , $T_C = 125^\circ\text{C}$)	$I_{F(AV)}$ Per device Per diode	30 15	A
Peak Repetitive Forward Current (Rated V_R , Square Wave, 20 kHz, $T_C = 120^\circ\text{C}$)	I_{FRM} Per device Per diode	60 30	A
Nonrepetitive Peak Surge Current (Surge applied at rated load conditions halfwave, single phase, 60 Hz)	I_{FSM}	160	A
Operating Junction Temperature	T_J	-40 to +150	$^\circ\text{C}$
Storage Temperature	T_{stg}	-40 to +150	$^\circ\text{C}$
Voltage Rate of Change (Rated V_R)	dv/dt	10,000	V/ μs

Stresses exceeding those listed in the Maximum Ratings table may damage the device. If any of these limits are exceeded, device functionality should not be assumed, damage may occur and reliability may be affected.

THERMAL CHARACTERISTICS

Rating	Symbol	NTST30U100CTG, NTSB30U100CT-1G	NTSB30U100CTG	NTSJ30U100CTG	Unit
Maximum Thermal Resistance per Diode Junction-to-Case Junction-to-Ambient	$R_{\theta JC}$ $R_{\theta JA}$	2.5 70	0.93 46.5	3.81 105	$^\circ\text{C}/\text{W}$ $^\circ\text{C}/\text{W}$

ELECTRICAL CHARACTERISTICS (Per Leg unless otherwise noted)

Rating	Symbol	Typ	Max	Unit
Maximum Instantaneous Forward Voltage (Note 1) ($I_F = 5\text{ A}$, $T_J = 25^\circ\text{C}$) ($I_F = 7.5\text{ A}$, $T_J = 25^\circ\text{C}$) ($I_F = 15\text{ A}$, $T_J = 25^\circ\text{C}$) ($I_F = 5\text{ A}$, $T_J = 125^\circ\text{C}$) ($I_F = 7.5\text{ A}$, $T_J = 125^\circ\text{C}$) ($I_F = 15\text{ A}$, $T_J = 125^\circ\text{C}$)	V_F	0.47 0.52 0.66 0.42 0.48 0.60	- - 0.80 - - 0.65	V
Maximum Instantaneous Reverse Current (Note 1) ($V_R = 70\text{ V}$, $T_J = 25^\circ\text{C}$) ($V_R = 70\text{ V}$, $T_J = 125^\circ\text{C}$) (Rated dc Voltage, $T_J = 25^\circ\text{C}$) (Rated dc Voltage, $T_J = 125^\circ\text{C}$)	I_R	15 12 65 32	 675 60	μA mA μA mA

Product parametric performance is indicated in the Electrical Characteristics for the listed test conditions, unless otherwise noted. Product performance may not be indicated by the Electrical Characteristics if operated under different conditions.

1. Pulse Test: Pulse Width = 300 μs , Duty Cycle $\leq 2.0\%$

TYPICAL CHARACTERISTICS

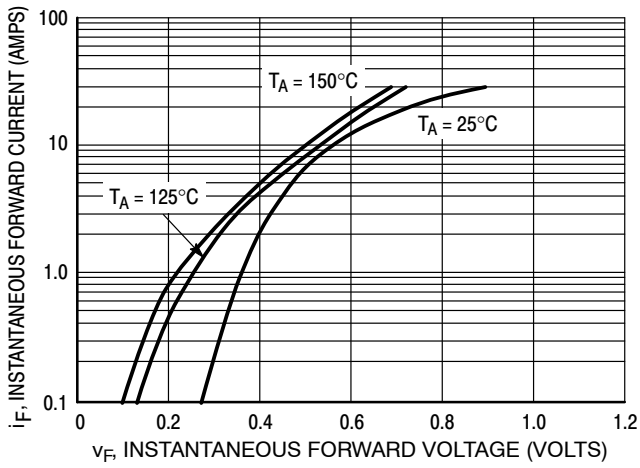

Figure 1. Typical Forward Voltage

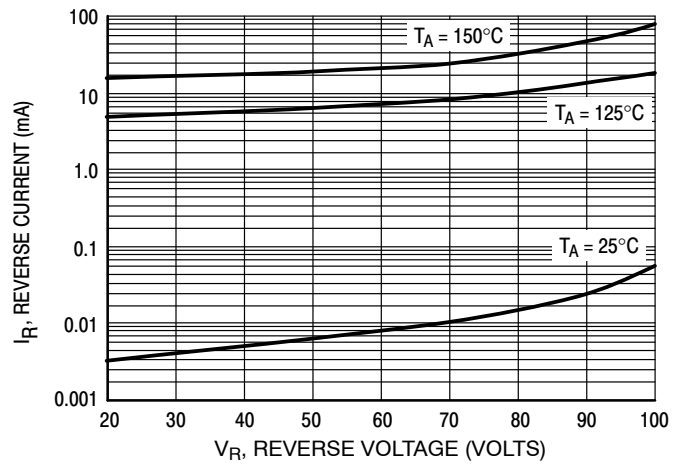

Figure 2. Typical Reverse Current

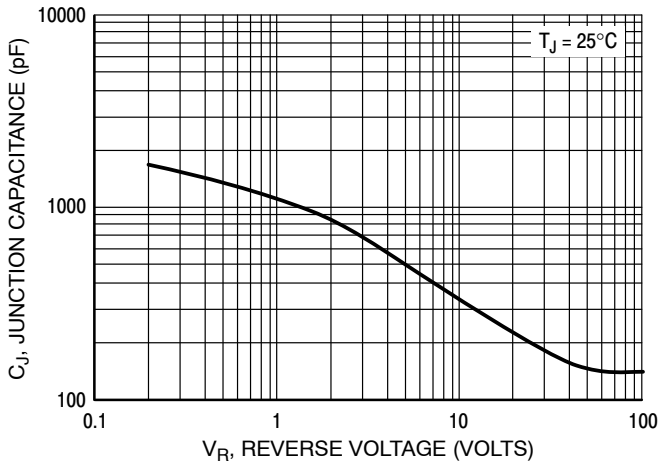

Figure 3. Typical Junction Capacitance

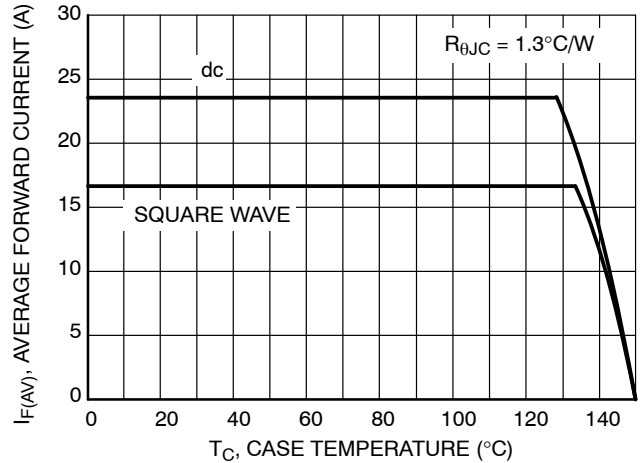

Figure 4. Current Derating per Leg

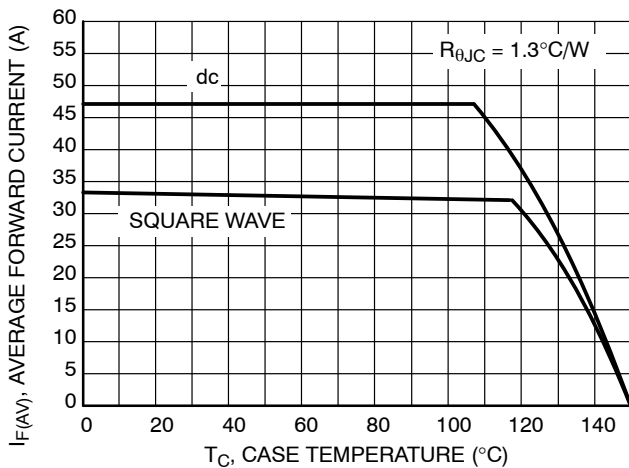

Figure 5. Current Derating, Case

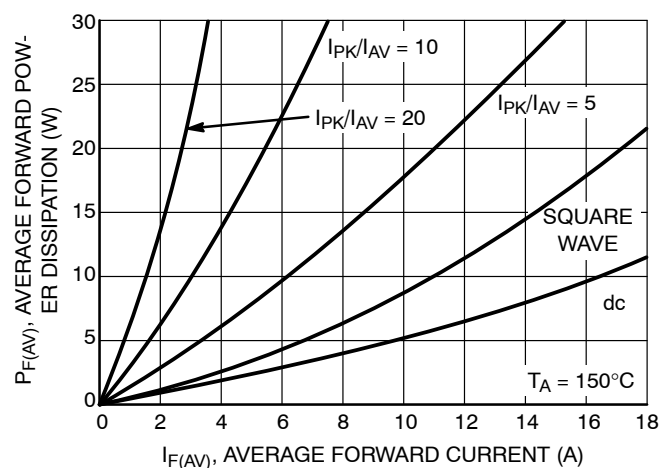

Figure 6. Forward Power Dissipation

TYPICAL CHARACTERISTICS

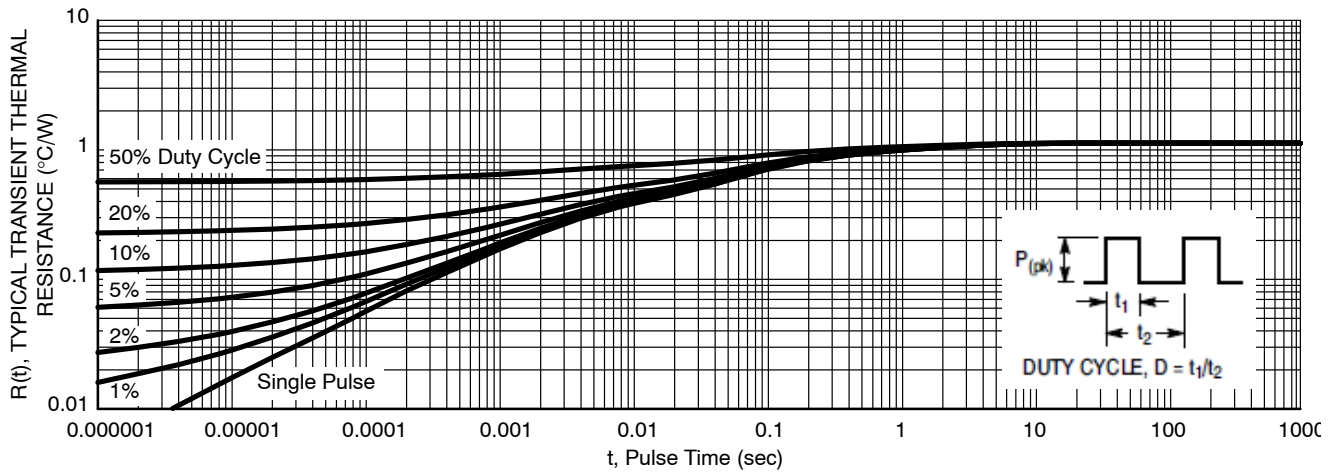

Figure 7. Typical Transient Thermal Response, Junction-to-Case for NTST30U100CT and NTSB30U100CT-1G

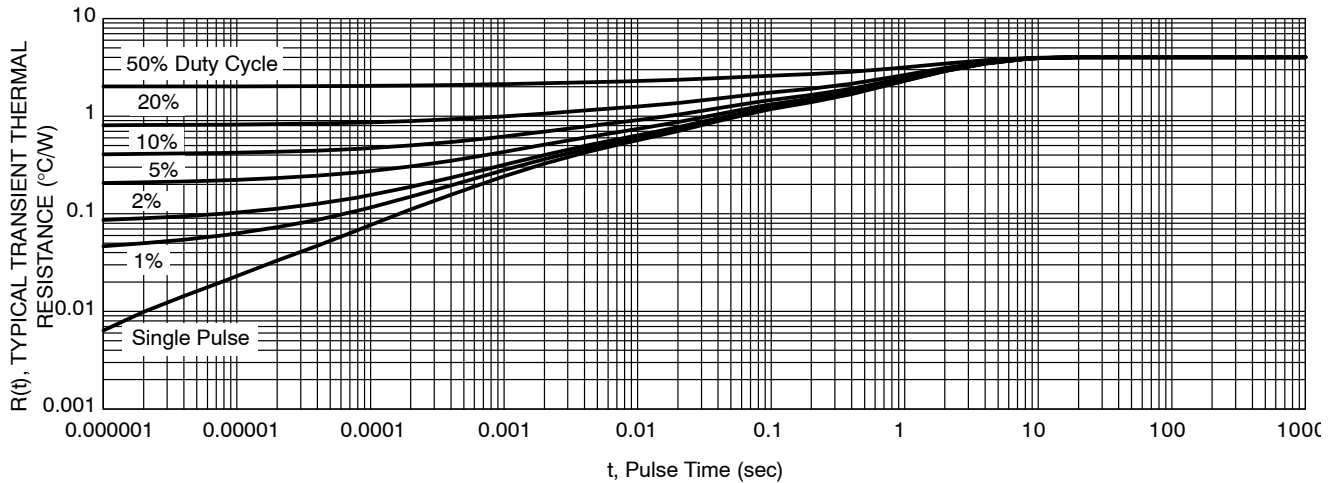

Figure 8. Typical Transient Thermal Response, Junction-to-Case for NTSJ30U100CTG

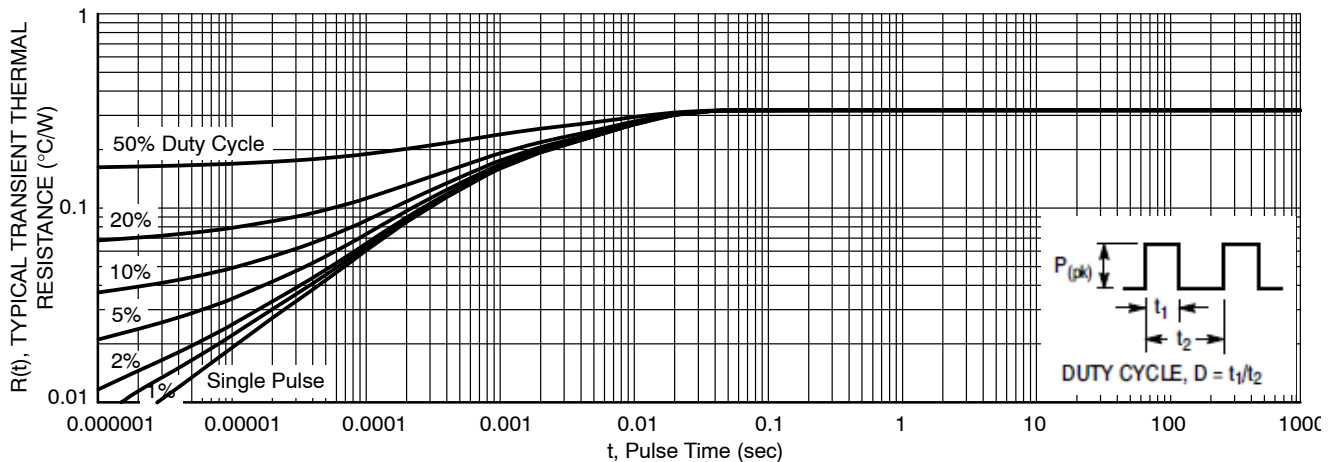

Figure 9. Typical Transient Thermal Response, Junction-to-Case for NTSB30U100CTG

NTST30U100CT, NTSB30U100CT-1, NTSJ30U100CTG, NTSB30U100CTG

ORDERING INFORMATION

Device	Package	Shipping†
NTST30U100CTG	TO-220AB (Pb-Free)	50 Units / Rail
NTST30U100CTH	TO-220AB (Halide-Free)	50 Units / Rail
NTSB30U100CT-1G	I ² PAK (Pb-Free)	50 Units / Rail
NTSJ30U100CTG	TO-220FP (Halide-Free)	50 Units / Rail
NTSB30U100CTG	D ² PAK (Pb-Free)	50 Units / Rail
NTSB30U100CTT4G	D ² PAK (Pb-Free)	800 / Tape & Reel

†For information on tape and reel specifications, including part orientation and tape sizes, please refer to our Tape and Reel Packaging Specifications Brochure, BRD8011/D.

MARKING DIAGRAMS

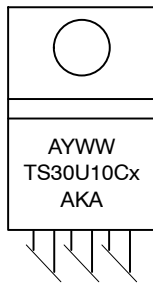

TO-220AB

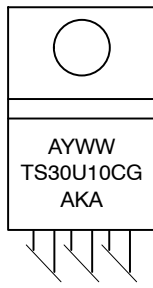

TO-220FP

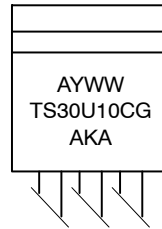

I²PAK



D²PAK

A = Assembly Location
 Y = Year
 WW = Work Week
 AKA = Polarity Designator
 x = G or H
 G = Pb-Free Package
 H = Halide-Free Package

MECHANICAL CASE OUTLINE PACKAGE DIMENSIONS

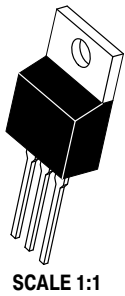

TO-220 CASE 221A ISSUE AK

DATE 13 JAN 2022



NOTES:

1. DIMENSIONING AND TOLERANCING PER ANSI Y14.5M, 2009.
2. CONTROLLING DIMENSION: INCHES
3. DIMENSION Z DEFINES A ZONE WHERE ALL BODY AND LEAD IRREGULARITIES ARE ALLOWED.
4. MAX WIDTH FOR F102 DEVICE = 1.35MM

DIM	INCHES		MILLIMETERS	
	MIN.	MAX.	MIN.	MAX.
A	0.570	0.620	14.48	15.75
B	0.380	0.415	9.66	10.53
C	0.160	0.190	4.07	4.83
D	0.025	0.038	0.64	0.96
F	0.142	0.161	3.60	4.09
G	0.095	0.105	2.42	2.66
H	0.110	0.161	2.80	4.10
J	0.014	0.024	0.36	0.61
K	0.500	0.562	12.70	14.27
L	0.045	0.060	1.15	1.52
N	0.190	0.210	4.83	5.33
Q	0.100	0.120	2.54	3.04
R	0.080	0.110	2.04	2.79
S	0.045	0.055	1.15	1.41
T	0.235	0.255	5.97	6.47
U	0.000	0.050	0.00	1.27
V	0.045	---	1.15	---
Z	---	0.080	---	2.04

STYLE 1:
PIN 1. BASE
2. COLLECTOR
3. EMITTER
4. COLLECTOR

STYLE 2:
PIN 1. BASE
2. EMITTER
3. COLLECTOR
4. EMITTER

STYLE 3:
PIN 1. CATHODE
2. ANODE
3. GATE
4. ANODE

STYLE 4:
PIN 1. MAIN TERMINAL 1
2. MAIN TERMINAL 2
3. GATE
4. MAIN TERMINAL 2

STYLE 5:
PIN 1. GATE
2. DRAIN
3. SOURCE
4. DRAIN

STYLE 6:
PIN 1. ANODE
2. CATHODE
3. ANODE
4. CATHODE

STYLE 7:
PIN 1. CATHODE
2. ANODE
3. CATHODE
4. ANODE

STYLE 8:
PIN 1. CATHODE
2. ANODE
3. EXTERNAL TRIP/DELAY
4. ANODE

STYLE 9:
PIN 1. GATE
2. COLLECTOR
3. EMITTER
4. COLLECTOR

STYLE 10:
PIN 1. GATE
2. SOURCE
3. DRAIN
4. SOURCE

STYLE 11:
PIN 1. DRAIN
2. SOURCE
3. GATE
4. SOURCE

STYLE 12:
PIN 1. MAIN TERMINAL 1
2. MAIN TERMINAL 2
3. GATE
4. NOT CONNECTED

DOCUMENT NUMBER:	98ASB42148B	Electronic versions are uncontrolled except when accessed directly from the Document Repository. Printed versions are uncontrolled except when stamped "CONTROLLED COPY" in red.
DESCRIPTION:	TO-220	PAGE 1 OF 1

onsemi and onsemi are trademarks of Semiconductor Components Industries, LLC dba onsemi or its subsidiaries in the United States and/or other countries. onsemi reserves the right to make changes without further notice to any products herein. onsemi makes no warranty, representation or guarantee regarding the suitability of its products for any particular purpose, nor does onsemi assume any liability arising out of the application or use of any product or circuit, and specifically disclaims any and all liability, including without limitation special, consequential or incidental damages. onsemi does not convey any license under its patent rights nor the rights of others.

MECHANICAL CASE OUTLINE

PACKAGE DIMENSIONS

ON Semiconductor®



TO-220 FULLPACK, 3-LEAD CASE 221AH ISSUE F

DATE 30 SEP 2014

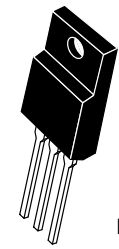

SCALE 1:1

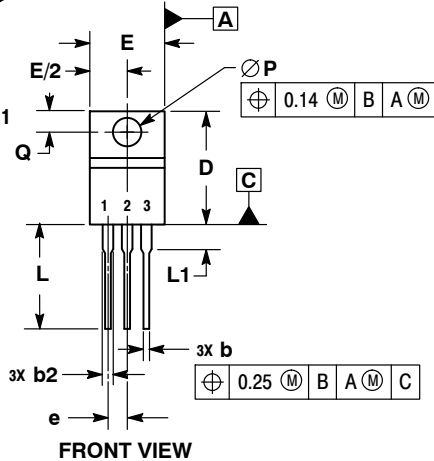

FRONT VIEW



SECTION D-D

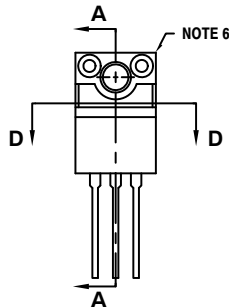

ALTERNATE CONSTRUCTION

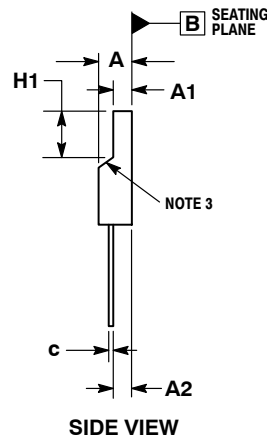

SIDE VIEW

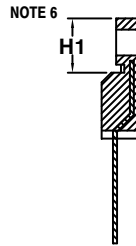

SECTION A-A

NOTES:

1. DIMENSIONING AND TOLERANCING PER ASME Y14.5M, 1994.
2. CONTROLLING DIMENSION: MILLIMETERS.
3. CONTOUR UNCONTROLLED IN THIS AREA.
4. DIMENSIONS D AND E DO NOT INCLUDE MOLD FLASH AND GATE PROTRUSIONS. MOLD FLASH AND GATE PROTRUSIONS NOT TO EXCEED 0.13 PER SIDE. THESE DIMENSIONS ARE TO BE MEASURED AT OUTERMOST EXTREME OF THE PLASTIC BODY.
5. DIMENSION b2 DOES NOT INCLUDE DAMBAR PROTRUSION. LEAD WIDTH INCLUDING PROTRUSION SHALL NOT EXCEED 2.00.
6. CONTOURS AND FEATURES OF THE MOLDED PACKAGE BODY MAY VARY WITHIN THE ENVELOPE DEFINED BY DIMENSIONS A1 AND H1 FOR MANUFACTURING PURPOSES.

MILLIMETERS		
DIM	MIN	MAX
A	4.30	4.70
A1	2.50	2.90
A2	2.50	2.90
b	0.54	0.84
b2	1.10	1.40
c	0.49	0.79
D	14.70	15.30
E	9.70	10.30
e	2.54 BSC	
H1	6.60	7.10
L	12.50	14.73
L1	---	2.80
P	3.00	3.40
Q	2.80	3.20

GENERIC MARKING DIAGRAM*

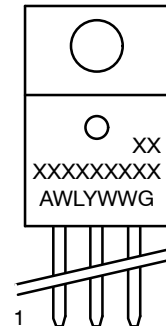

- A = Assembly Location
- WL = Wafer Lot
- Y = Year
- WW = Work Week
- G = Pb-Free Package

*This information is generic. Please refer to device data sheet for actual part marking. Pb-Free indicator, "G" or microdot "▪", may or may not be present.

STYLE 1:

1. MAIN TERMINAL 1
2. MAIN TERMINAL 2
3. GATE

STYLE 2:

1. CATHODE
2. ANODE
3. GATE

DOCUMENT NUMBER:	98AON52577E	Electronic versions are uncontrolled except when accessed directly from the Document Repository. Printed versions are uncontrolled except when stamped "CONTROLLED COPY" in red.
DESCRIPTION:	TO-220 FULLPACK, 3-LEAD	PAGE 1 OF 1

ON Semiconductor and are trademarks of Semiconductor Components Industries, LLC dba ON Semiconductor or its subsidiaries in the United States and/or other countries. ON Semiconductor reserves the right to make changes without further notice to any products herein. ON Semiconductor makes no warranty, representation or guarantee regarding the suitability of its products for any particular purpose, nor does ON Semiconductor assume any liability arising out of the application or use of any product or circuit, and specifically disclaims any and all liability, including without limitation special, consequential or incidental damages. ON Semiconductor does not convey any license under its patent rights nor the rights of others.

MECHANICAL CASE OUTLINE

PACKAGE DIMENSIONS

ON Semiconductor®

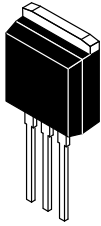

SCALE 1:1

I²PAK (TO-262)
CASE 418D-01
ISSUE D

DATE 16 OCT 2007

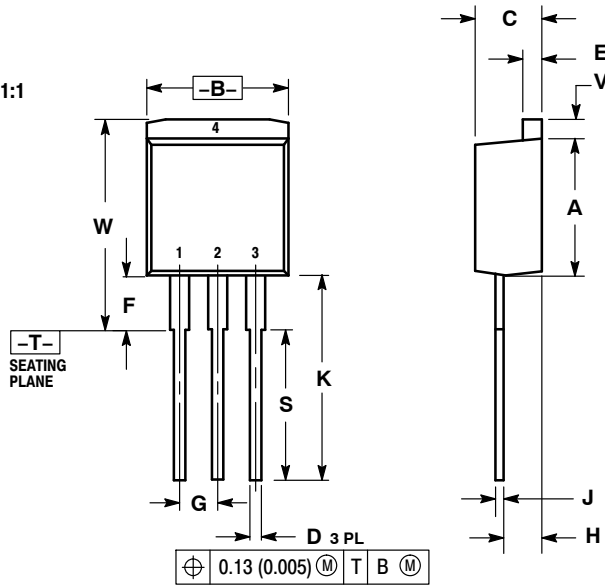

- NOTES:
1. DIMENSIONING AND TOLERANCING PER ANSI Y14.5M, 1982.
 2. CONTROLLING DIMENSION: INCH.

DIM	INCHES		MILLIMETERS	
	MIN	MAX	MIN	MAX
A	0.335	0.380	8.51	9.65
B	0.380	0.406	9.65	10.31
C	0.160	0.185	4.06	4.70
D	0.026	0.035	0.66	0.89
E	0.045	0.055	1.14	1.40
F	0.122 REF		3.10 REF	
G	0.100 BSC		2.54 BSC	
H	0.094	0.110	2.39	2.79
J	0.013	0.025	0.33	0.64
K	0.500	0.562	12.70	14.27
S	0.390 REF		9.90 REF	
V	0.045	0.070	1.14	1.78
W	0.522	0.551	13.25	14.00

STYLE 1:

- PIN 1. BASE
2. COLLECTOR
3. EMITTER
4. COLLECTOR

STYLE 2:

- PIN 1. GATE
2. DRAIN
3. SOURCE
4. DRAIN

STYLE 3:

- PIN 1. ANODE
2. CATHODE
3. ANODE
4. CATHODE

STYLE 4:

- PIN 1. GATE
2. COLLECTOR
3. EMITTER
4. COLLECTOR

DOCUMENT NUMBER:	98ASB16716C	Electronic versions are uncontrolled except when accessed directly from the Document Repository. Printed versions are uncontrolled except when stamped "CONTROLLED COPY" in red.
DESCRIPTION:	I ² PAK (TO-262)	PAGE 1 OF 1

ON Semiconductor and are trademarks of Semiconductor Components Industries, LLC dba ON Semiconductor or its subsidiaries in the United States and/or other countries. ON Semiconductor reserves the right to make changes without further notice to any products herein. ON Semiconductor makes no warranty, representation or guarantee regarding the suitability of its products for any particular purpose, nor does ON Semiconductor assume any liability arising out of the application or use of any product or circuit, and specifically disclaims any and all liability, including without limitation special, consequential or incidental damages. ON Semiconductor does not convey any license under its patent rights nor the rights of others.

MECHANICAL CASE OUTLINE

PACKAGE DIMENSIONS

ON Semiconductor®



D²PAK 3
CASE 418B-04
ISSUE L

DATE 17 FEB 2015

SCALE 1:1

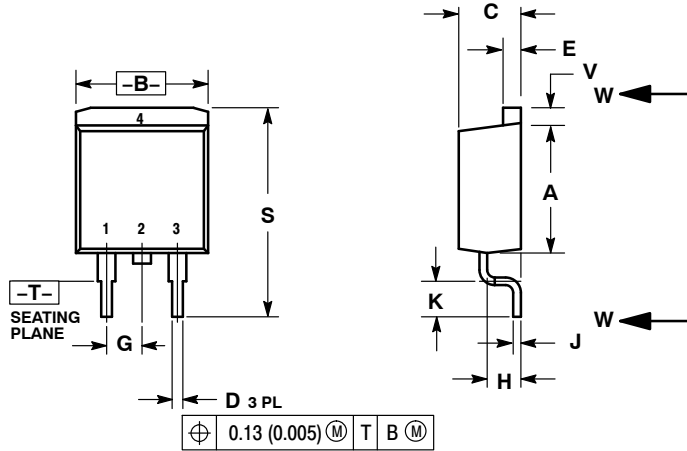

NOTES:

- DIMENSIONING AND TOLERANCING PER ANSI Y14.5M, 1982.
- CONTROLLING DIMENSION: INCH.
- 418B-01 THRU 418B-03 OBSOLETE, NEW STANDARD 418B-04.

DIM	INCHES		MILLIMETERS	
	MIN	MAX	MIN	MAX
A	0.340	0.380	8.64	9.65
B	0.380	0.405	9.65	10.29
C	0.160	0.190	4.06	4.83
D	0.020	0.035	0.51	0.89
E	0.045	0.055	1.14	1.40
F	0.310	0.350	7.87	8.89
G	0.100	BSC	2.54	BSC
H	0.080	0.110	2.03	2.79
J	0.018	0.025	0.46	0.64
K	0.090	0.110	2.29	2.79
L	0.052	0.072	1.32	1.83
M	0.280	0.320	7.11	8.13
N	0.197	REF	5.00	REF
P	0.079	REF	2.00	REF
R	0.039	REF	0.99	REF
S	0.575	0.625	14.60	15.88
V	0.045	0.055	1.14	1.40

VARIABLE CONFIGURATION ZONE

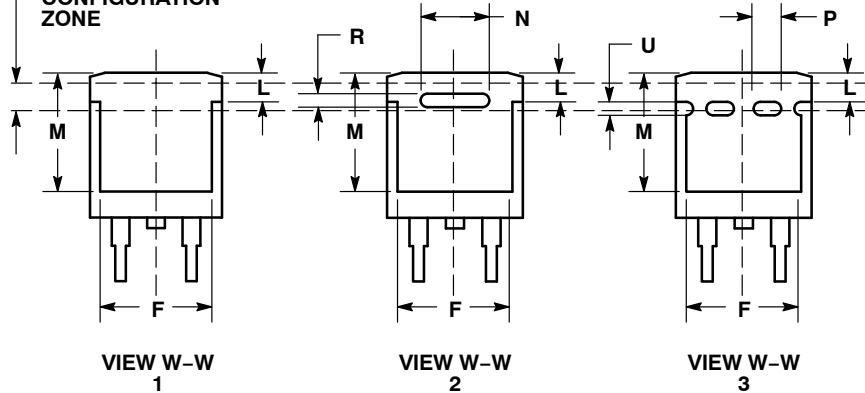

- | | | | | | |
|--|---|---|--|---|--|
| STYLE 1:
PIN 1. BASE
2. COLLECTOR
3. EMITTER
4. COLLECTOR | STYLE 2:
PIN 1. GATE
2. DRAIN
3. SOURCE
4. DRAIN | STYLE 3:
PIN 1. ANODE
2. CATHODE
3. ANODE
4. CATHODE | STYLE 4:
PIN 1. GATE
2. COLLECTOR
3. EMITTER
4. COLLECTOR | STYLE 5:
PIN 1. CATHODE
2. ANODE
3. CATHODE
4. ANODE | STYLE 6:
PIN 1. NO CONNECT
2. CATHODE
3. ANODE
4. CATHODE |
|--|---|---|--|---|--|

MARKING INFORMATION AND FOOTPRINT ON PAGE 2

DOCUMENT NUMBER:	98ASB42761B	Electronic versions are uncontrolled except when accessed directly from the Document Repository. Printed versions are uncontrolled except when stamped "CONTROLLED COPY" in red.
DESCRIPTION:	D²PAK 3	PAGE 1 OF 2

ON Semiconductor and are trademarks of Semiconductor Components Industries, LLC dba ON Semiconductor or its subsidiaries in the United States and/or other countries. ON Semiconductor reserves the right to make changes without further notice to any products herein. ON Semiconductor makes no warranty, representation or guarantee regarding the suitability of its products for any particular purpose, nor does ON Semiconductor assume any liability arising out of the application or use of any product or circuit, and specifically disclaims any and all liability, including without limitation special, consequential or incidental damages. ON Semiconductor does not convey any license under its patent rights nor the rights of others.

D²PAK 3
CASE 418B-04
ISSUE L

DATE 17 FEB 2015

**GENERIC
MARKING DIAGRAM***

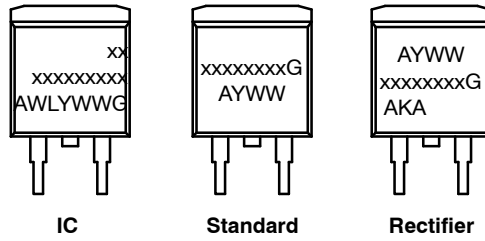

- xx = Specific Device Code
- A = Assembly Location
- WL = Wafer Lot
- Y = Year
- WW = Work Week
- G = Pb-Free Package
- AKA = Polarity Indicator

*This information is generic. Please refer to device data sheet for actual part marking. Pb-Free indicator, "G" or microdot "▪", may or may not be present.

SOLDERING FOOTPRINT*

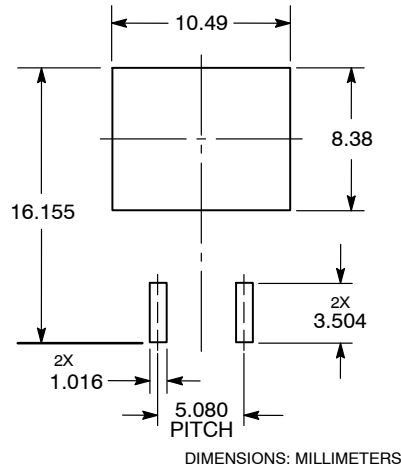

*For additional information on our Pb-Free strategy and soldering details, please download the ON Semiconductor Soldering and Mounting Techniques Reference Manual, SOLDERRM/D.

DOCUMENT NUMBER:	98ASB42761B	Electronic versions are uncontrolled except when accessed directly from the Document Repository. Printed versions are uncontrolled except when stamped "CONTROLLED COPY" in red.
DESCRIPTION:	D²PAK 3	PAGE 2 OF 2

ON Semiconductor and are trademarks of Semiconductor Components Industries, LLC dba ON Semiconductor or its subsidiaries in the United States and/or other countries. ON Semiconductor reserves the right to make changes without further notice to any products herein. ON Semiconductor makes no warranty, representation or guarantee regarding the suitability of its products for any particular purpose, nor does ON Semiconductor assume any liability arising out of the application or use of any product or circuit, and specifically disclaims any and all liability, including without limitation special, consequential or incidental damages. ON Semiconductor does not convey any license under its patent rights nor the rights of others.

onsemi, **Onsemi**, and other names, marks, and brands are registered and/or common law trademarks of Semiconductor Components Industries, LLC dba "**onsemi**" or its affiliates and/or subsidiaries in the United States and/or other countries. **onsemi** owns the rights to a number of patents, trademarks, copyrights, trade secrets, and other intellectual property. A listing of **onsemi**'s product/patent coverage may be accessed at www.onsemi.com/site/pdf/Patent-Marking.pdf. **onsemi** reserves the right to make changes at any time to any products or information herein, without notice. The information herein is provided "as-is" and **onsemi** makes no warranty, representation or guarantee regarding the accuracy of the information, product features, availability, functionality, or suitability of its products for any particular purpose, nor does **onsemi** assume any liability arising out of the application or use of any product or circuit, and specifically disclaims any and all liability, including without limitation special, consequential or incidental damages. Buyer is responsible for its products and applications using **onsemi** products, including compliance with all laws, regulations and safety requirements or standards, regardless of any support or applications information provided by **onsemi**. "Typical" parameters which may be provided in **onsemi** data sheets and/or specifications can and do vary in different applications and actual performance may vary over time. All operating parameters, including "Typicals" must be validated for each customer application by customer's technical experts. **onsemi** does not convey any license under any of its intellectual property rights nor the rights of others. **onsemi** products are not designed, intended, or authorized for use as a critical component in life support systems or any FDA Class 3 medical devices or medical devices with a same or similar classification in a foreign jurisdiction or any devices intended for implantation in the human body. Should Buyer purchase or use **onsemi** products for any such unintended or unauthorized application, Buyer shall indemnify and hold **onsemi** and its officers, employees, subsidiaries, affiliates, and distributors harmless against all claims, costs, damages, and expenses, and reasonable attorney fees arising out of, directly or indirectly, any claim of personal injury or death associated with such unintended or unauthorized use, even if such claim alleges that **onsemi** was negligent regarding the design or manufacture of the part. **onsemi** is an Equal Opportunity/Affirmative Action Employer. This literature is subject to all applicable copyright laws and is not for resale in any manner.

PUBLICATION ORDERING INFORMATION

LITERATURE FULFILLMENT:

Email Requests to: orderlit@onsemi.com

onsemi Website: www.onsemi.com

TECHNICAL SUPPORT

North American Technical Support:

Voice Mail: 1 800-282-9855 Toll Free USA/Canada

Phone: 011 421 33 790 2910

Europe, Middle East and Africa Technical Support:

Phone: 00421 33 790 2910

For additional information, please contact your local Sales Representative