

NTLTS3107P

Power MOSFET

-20 V, -8.3 A, Single P-Channel, Micro8 Leadless Package

Features

- Low $R_{DS(on)}$ for Extended Battery Life
- Surface Mount Micro8 Leadless for Improved Thermal Performance
- Low Profile (<1.0 mm) Optimal for Portable Designs
- Low Turn-On Voltage
- This is a Pb-Free Device

Applications

- Optimized for Load Management Applications
- Charge Control in Battery Powered Systems
- Cell Phones, DSC, Notebooks, Portable Games, etc.

MAXIMUM RATINGS ($T_J = 25^\circ\text{C}$ unless otherwise stated)

Parameter		Symbol	Value	Unit	
Drain-to-Source Voltage		V_{DSS}	-20	V	
Gate-to-Source Voltage		V_{GS}	± 8.0	V	
Continuous Drain Current (Note 1)	Steady State	$T_A = 25^\circ\text{C}$	I_D	-8.3	A
			$T_A = 85^\circ\text{C}$	-6.0	
	$t \leq 10\text{ s}$	$T_A = 25^\circ\text{C}$		-12	
Power Dissipation (Note 1)	Steady State	$T_A = 25^\circ\text{C}$	P_D	1.6	W
			$t \leq 10\text{ s}$	3.3	
Continuous Drain Current (Note 2)	Steady State	$T_A = 25^\circ\text{C}$	I_D	-5.9	A
		$T_A = 85^\circ\text{C}$		-3.7	
Power Dissipation (Note 2)		$T_A = 25^\circ\text{C}$	P_D	0.8	W
Pulsed Drain Current (Note 1)	$t_p = 10\ \mu\text{s}$	I_{DM}	-25	A	
Operating Junction and Storage Temperature		T_J, T_{STG}	-55 to 150	$^\circ\text{C}$	
Source Current (Body Diode)		I_S	-1.6	A	
Lead Temperature for Soldering Purposes (1/8 in from case for 10 s)		T_L	260	$^\circ\text{C}$	

THERMAL RESISTANCE RATINGS

Parameter	Symbol	Max	Unit
Junction-to-Ambient – Steady State (Note 1)	$R_{\theta JA}$	80	$^\circ\text{C}/\text{W}$
Junction-to-Ambient – $t \leq 10\text{ s}$ (Note 1)	$R_{\theta JA}$	38	$^\circ\text{C}/\text{W}$
Junction-to-Ambient – Steady State (Note 2)	$R_{\theta JA}$	160	$^\circ\text{C}/\text{W}$

Stresses exceeding Maximum Ratings may damage the device. Maximum Ratings are stress ratings only. Functional operation above the Recommended Operating Conditions is not implied. Extended exposure to stresses above the Recommended Operating Conditions may affect device reliability.

1. Surface-mounted on FR4 board using 1 sq. in. pad size (Cu. area = 1.127 sq. in. [1 oz] including traces).
2. Surface-mounted on FR4 board using minimum recommended pad size (Cu. area = TBD sq. in.).



ON Semiconductor[®]

<http://onsemi.com>

$V_{(BR)DSS}$	$R_{DS(on)}$ TYP	I_D MAX
-20 V	12.2 m Ω @ -4.5 V	-8.3 A
	15.6 m Ω @ -2.5 V	
	26.2 m Ω @ -1.8 V	

P-Channel MOSFET

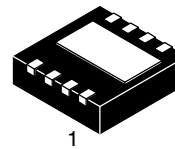
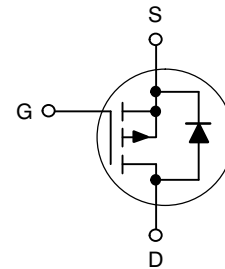

Micro8 Leadless CASE 846C

MARKING DIAGRAM

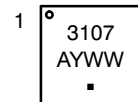

- A = Assembly Location
- Y = Year
- WW = Work Week
- = Pb-Free Package

PIN ASSIGNMENT

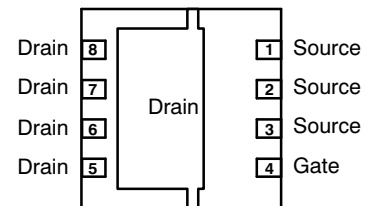

(Bottom View)

ORDERING INFORMATION

Device	Package	Shipping [†]
NTLTS3107PR2G	Micro8 (Pb-Free)	2500/Tape & Reel

[†]For information on tape and reel specifications, including part orientation and tape sizes, please refer to our Tape and Reel Packaging Specification Brochure, BRD8011/D.

NTLTS3107P

ELECTRICAL CHARACTERISTICS (T_J = 25°C unless otherwise specified)

Parameter	Symbol	Test Condition	Min	Typ	Max	Unit
OFF CHARACTERISTICS						
Drain-to-Source Breakdown Voltage	V _{(BR)DSS}	V _{GS} = 0 V, I _D = -250 μA	-20			V
Drain-to-Source Breakdown Voltage Temperature Coefficient	V _{(BR)DSS} /T _J			11		mV/°C
Zero Gate Voltage Drain Current	I _{DSS}	V _{GS} = 0 V, V _{DS} = -16 V			-10	μA
Gate-to-Source Leakage Current	I _{GSS}	V _{DS} = 0 V, V _{GS} = ±8.0 V			±100	nA

ON CHARACTERISTICS (Note 3)

Gate Threshold Voltage	V _{GS(TH)}	V _{GS} = V _{DS} , I _D = -250 μA	-0.45		-1.2	V	
Negative Threshold Temperature Coefficient	V _{GS(TH)} /T _J			3.4		mV/°C	
Drain-to-Source On Resistance	R _{DS(on)}	V _{GS} = -4.5 V, I _D = -8.0 A		12.2	16	mΩ	
					15.6		21
					26.2		
Forward Transconductance	g _{FS}	V _{DS} = -5 V, I _D = -8.0 A		25		S	

CHARGES AND CAPACITANCES

Input Capacitance	C _{ISS}	V _{GS} = 0 V, f = 1 MHz, V _{DS} = -16 V		5900	6500	pF
Output Capacitance	C _{OSS}			625	675	
Reverse Transfer Capacitance	C _{RSS}			425	525	
Total Gate Charge	Q _{G(TOT)}	V _{GS} = -4.5 V, V _{DS} = -16 V, I _D = -8.0 A		55	70	nC
Threshold Gate Charge	Q _{G(TH)}			3.0		
Gate-to-Source Gate Charge	Q _{GS}			7.0		
Gate-to-Drain "Miller" Charge	Q _{GD}			11		

SWITCHING CHARACTERISTICS (Note 4)

Turn-On Delay Time	t _{d(on)}	V _{GS} = -4.5 V, V _{DS} = -10 V, I _D = -8.0 A, R _G = 3.0 Ω		30		ns
Rise Time	t _r			20		
Turn-Off Delay Time	t _{d(off)}			250		
Fall Time	t _f			80		

DRAIN-SOURCE DIODE CHARACTERISTICS (Note 3)

Forward Diode Voltage	V _{SD}	V _{GS} = 0 V, I _S = -1.6 A	T _J = 25°C		-0.7	-1.2	V
			T _J = 125°C		0.5		
Reverse Recovery Time	t _{RR}	V _{GS} = 0 V, dI _S /dt = 100 A/μs, I _S = -1.6 A		75	100	ns	
Charge Time	t _a			28			
Discharge Time	t _b			47			
Reverse Recovery Charge	Q _{RR}			81.5		nC	

3. Pulse Test: pulse width ≤ 300 μs, duty cycle ≤ 2%.

4. Switching characteristics are independent of operating junction temperatures.

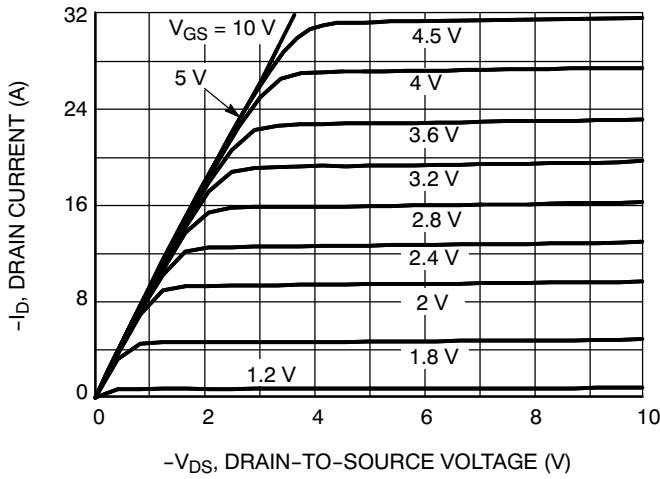

Figure 1. On-Region Characteristics

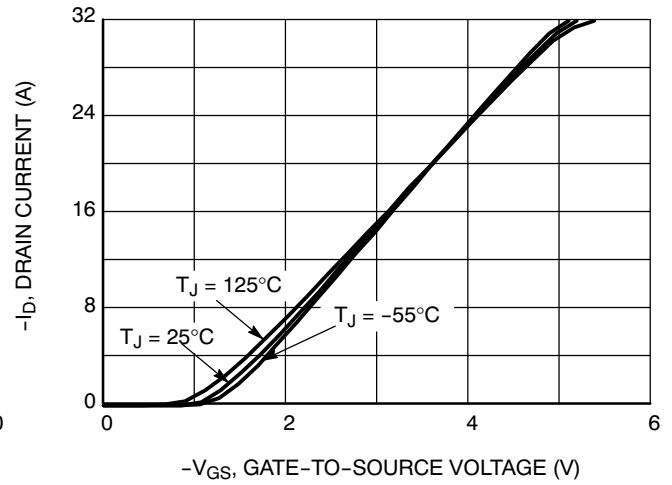

Figure 2. Transfer Characteristics

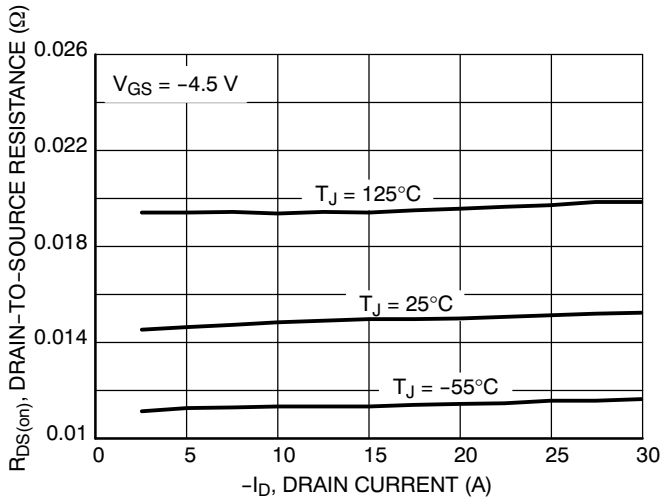

Figure 3. On-Resistance versus Drain Current and Temperature

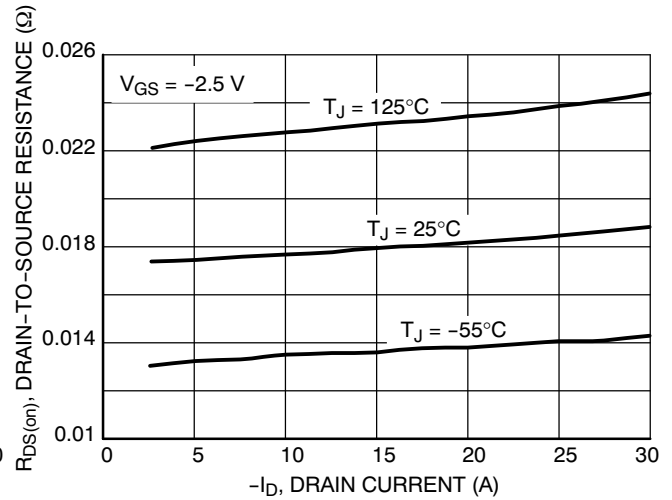

Figure 4. On-Resistance versus Drain Current and Temperature

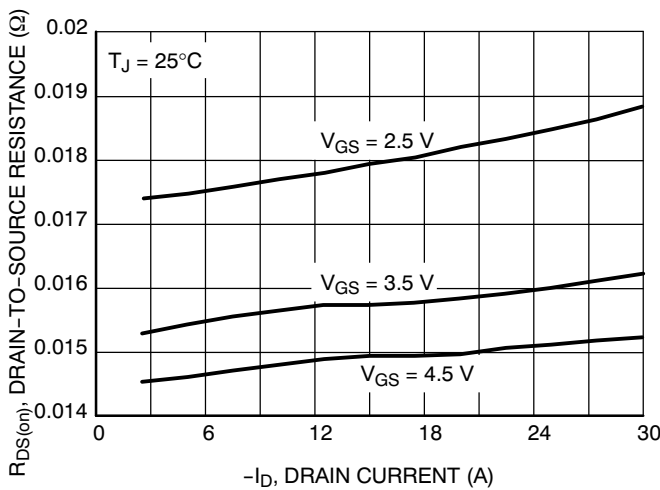

Figure 5. On-Resistance versus Drain Current and Gate Voltage

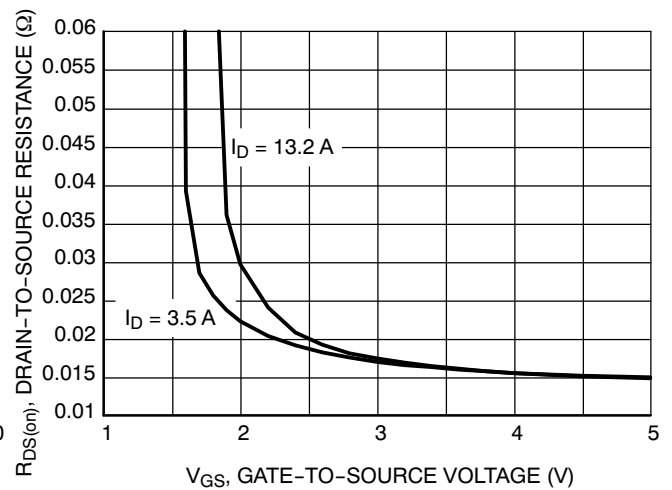

Figure 6. On-Resistance versus Gate Voltage

NTLTS3107P

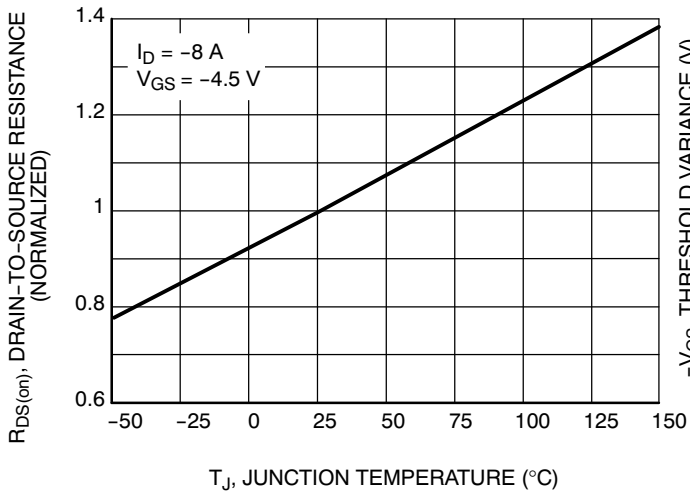

Figure 7. On-Resistance Variation with Temperature

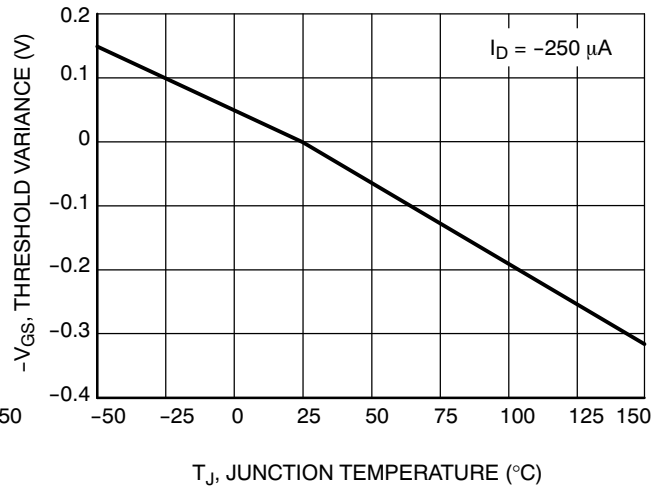

Figure 8. Threshold Voltage

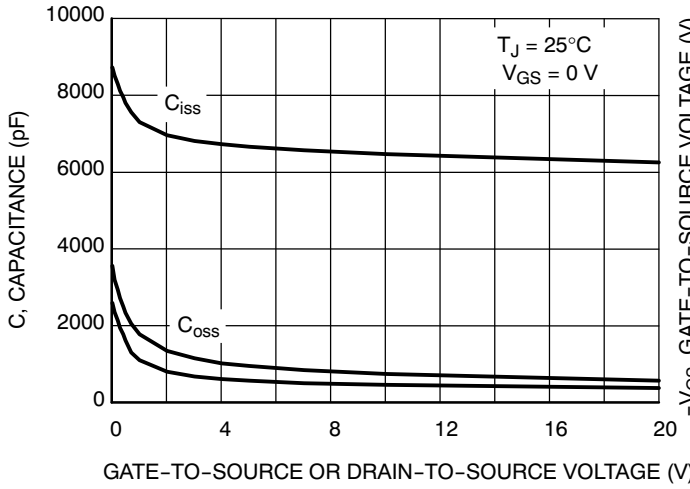

Figure 9. Capacitance Variation

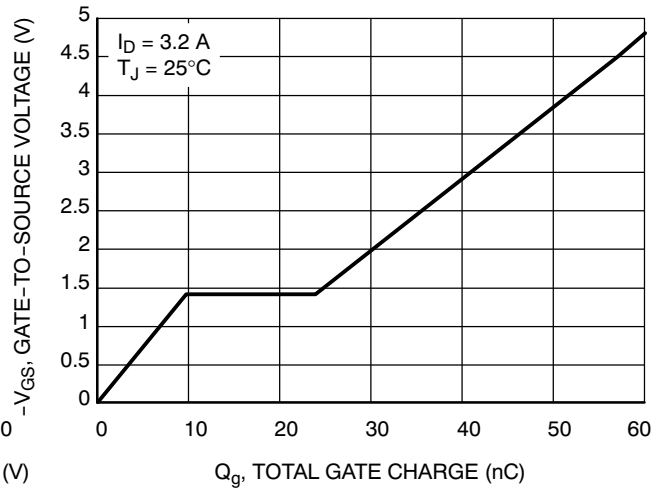

Figure 10. Gate-to-Source and Drain-to-Source Voltage versus Total Charge

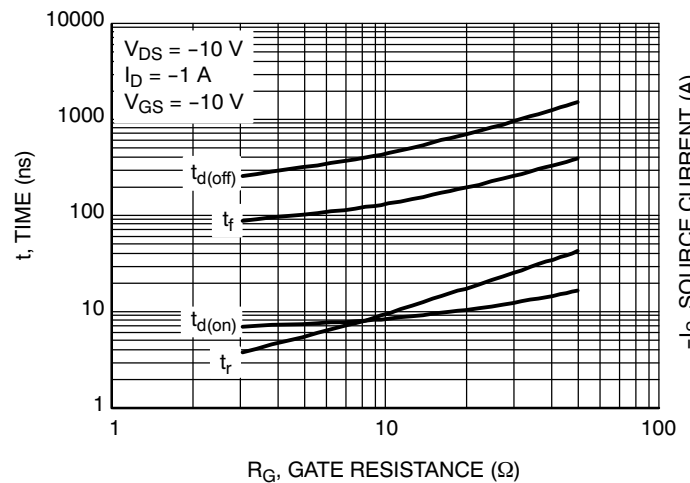

Figure 11. Resistive Switching Time Variation versus Gate Resistance

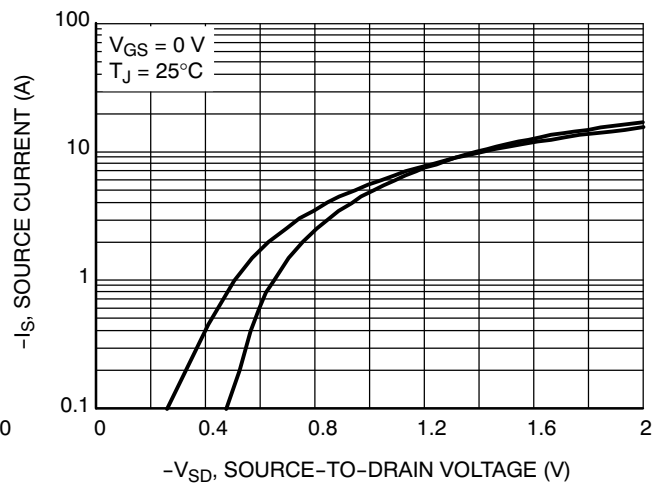
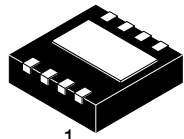

Figure 12. Diode Forward Voltage versus Current

MECHANICAL CASE OUTLINE

PACKAGE DIMENSIONS

ON Semiconductor®



DFN8 3x3, (MICRO8 LEADLESS)

CASE 846C-01
ISSUE D

DATE 28 JUN 2010

SCALE 4:1

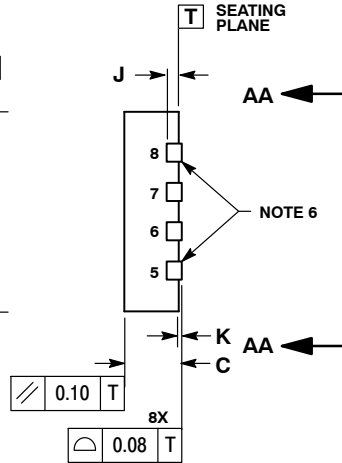
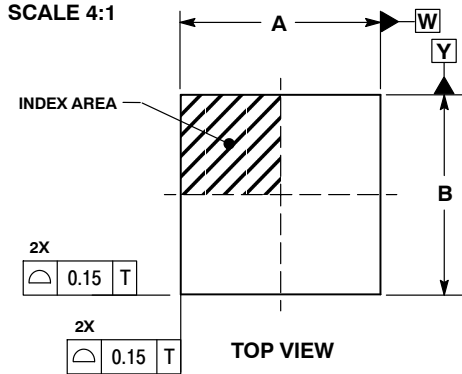

NOTES:

1. DIMENSIONS AND TOLERANCING PER ASME Y14.5M, 1994.
2. CONTROLLING DIMENSION: MILLIMETER.
3. THE TERMINAL #1 IDENTIFIER AND TERMINAL NUMBERING CONVENTION SHALL CONFORM TO JESD 95-1 SPP-012. DETAILS OF TERMINAL #1 IDENTIFIER ARE OPTIONAL, BUT MUST BE LOCATED WITHIN THE ZONE INDICATED. THE TERMINAL #1 IDENTIFIER MAY BE EITHER A MOLD OR MARKED FEATURE.
4. DIMENSION D APPLIES TO METALLIZED TERMINAL AND IS MEASURED BETWEEN 0.25 MM AND 0.30 MM FROM TERMINAL TIP. DIMENSION L1 IS THE TERMINAL PULL BACK FROM PACKAGE EDGE, UP TO 0.1 MM IS ACCEPTABLE. L1 IS OPTIONAL.
5. DEPOPULATION IS POSSIBLE IN A SYMMETRICAL FASHION.
6. OPTIONAL SIDE VIEW CAN SHOW LEADS 5 AND 8 REMOVED.

NOTE 4

\oplus	0.10	T	W	Y
	0.05	T	W	

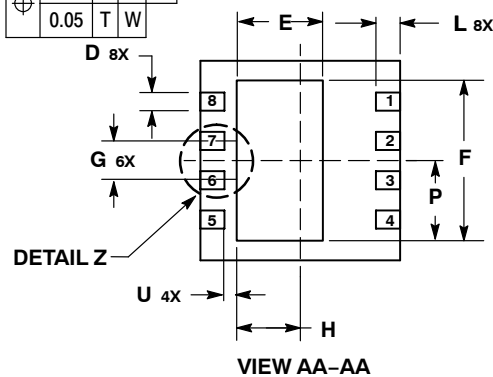

SIDE VIEW

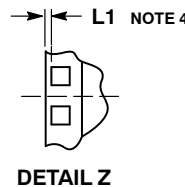

DIM	MILLIMETERS	
	MIN	MAX
A	3.30	BSC
B	3.30	BSC
C	0.85	0.95
D	0.25	0.35
E	1.30	1.50
F	2.55	2.75
G	0.65	BSC
H	0.95	1.15
J	0.25	BSC
K	0.00	0.05
L	0.35	0.45
L1	0.00	0.10
P	1.28	1.38
U	0.17	TYP

GENERIC MARKING DIAGRAM*

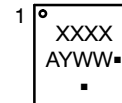

- XXXX = Specific Device Code
- A = Assembly Location
- Y = Year
- WW = Work Week
- = Pb-Free Package

(Note: Microdot may be in either location)

*This information is generic. Please refer to device data sheet for actual part marking. Pb-Free indicator, "G" or microdot "▪", may or may not be present.

SOLDERING FOOTPRINT*

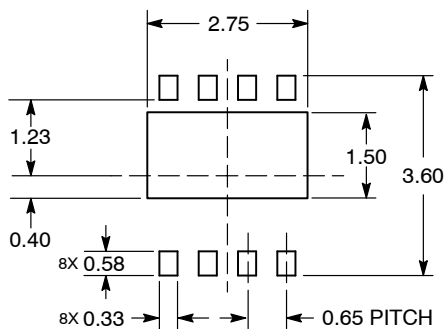

DIMENSIONS: MILLIMETERS

*For additional information on our Pb-Free strategy and soldering details, please download the ON Semiconductor Soldering and Mounting Techniques Reference Manual, SOLDERRM/D.

DOCUMENT NUMBER:	98AON11449D	Electronic versions are uncontrolled except when accessed directly from the Document Repository. Printed versions are uncontrolled except when stamped "CONTROLLED COPY" in red.
DESCRIPTION:	DFN8 3X3, (MICRO8 LEADLESS)	PAGE 1 OF 1

ON Semiconductor and ON are trademarks of Semiconductor Components Industries, LLC dba ON Semiconductor or its subsidiaries in the United States and/or other countries. ON Semiconductor reserves the right to make changes without further notice to any products herein. ON Semiconductor makes no warranty, representation or guarantee regarding the suitability of its products for any particular purpose, nor does ON Semiconductor assume any liability arising out of the application or use of any product or circuit, and specifically disclaims any and all liability, including without limitation special, consequential or incidental damages. ON Semiconductor does not convey any license under its patent rights nor the rights of others.

onsemi, **Onsemi**, and other names, marks, and brands are registered and/or common law trademarks of Semiconductor Components Industries, LLC dba "**onsemi**" or its affiliates and/or subsidiaries in the United States and/or other countries. **onsemi** owns the rights to a number of patents, trademarks, copyrights, trade secrets, and other intellectual property. A listing of **onsemi**'s product/patent coverage may be accessed at www.onsemi.com/site/pdf/Patent-Marking.pdf. **onsemi** reserves the right to make changes at any time to any products or information herein, without notice. The information herein is provided "as-is" and **onsemi** makes no warranty, representation or guarantee regarding the accuracy of the information, product features, availability, functionality, or suitability of its products for any particular purpose, nor does **onsemi** assume any liability arising out of the application or use of any product or circuit, and specifically disclaims any and all liability, including without limitation special, consequential or incidental damages. Buyer is responsible for its products and applications using **onsemi** products, including compliance with all laws, regulations and safety requirements or standards, regardless of any support or applications information provided by **onsemi**. "Typical" parameters which may be provided in **onsemi** data sheets and/or specifications can and do vary in different applications and actual performance may vary over time. All operating parameters, including "Typicals" must be validated for each customer application by customer's technical experts. **onsemi** does not convey any license under any of its intellectual property rights nor the rights of others. **onsemi** products are not designed, intended, or authorized for use as a critical component in life support systems or any FDA Class 3 medical devices or medical devices with a same or similar classification in a foreign jurisdiction or any devices intended for implantation in the human body. Should Buyer purchase or use **onsemi** products for any such unintended or unauthorized application, Buyer shall indemnify and hold **onsemi** and its officers, employees, subsidiaries, affiliates, and distributors harmless against all claims, costs, damages, and expenses, and reasonable attorney fees arising out of, directly or indirectly, any claim of personal injury or death associated with such unintended or unauthorized use, even if such claim alleges that **onsemi** was negligent regarding the design or manufacture of the part. **onsemi** is an Equal Opportunity/Affirmative Action Employer. This literature is subject to all applicable copyright laws and is not for resale in any manner.

PUBLICATION ORDERING INFORMATION

LITERATURE FULFILLMENT:

Email Requests to: orderlit@onsemi.com

onsemi Website: www.onsemi.com

TECHNICAL SUPPORT

North American Technical Support:
Voice Mail: 1 800-282-9855 Toll Free USA/Canada
Phone: 011 421 33 790 2910

Europe, Middle East and Africa Technical Support:

Phone: 00421 33 790 2910

For additional information, please contact your local Sales Representative