

# ON Semiconductor

## Is Now

# onsemi™

To learn more about onsemi™, please visit our website at  
[www.onsemi.com](http://www.onsemi.com)

---

**onsemi** and **onsemi** and other names, marks, and brands are registered and/or common law trademarks of Semiconductor Components Industries, LLC dba "**onsemi**" or its affiliates and/or subsidiaries in the United States and/or other countries. **onsemi** owns the rights to a number of patents, trademarks, copyrights, trade secrets, and other intellectual property. A listing of **onsemi** product/patent coverage may be accessed at [www.onsemi.com/site/pdf/Patent-Marking.pdf](http://www.onsemi.com/site/pdf/Patent-Marking.pdf). **onsemi** reserves the right to make changes at any time to any products or information herein, without notice. The information herein is provided "as-is" and **onsemi** makes no warranty, representation or guarantee regarding the accuracy of the information, product features, availability, functionality, or suitability of its products for any particular purpose, nor does **onsemi** assume any liability arising out of the application or use of any product or circuit, and specifically disclaims any and all liability, including without limitation special, consequential or incidental damages. Buyer is responsible for its products and applications using **onsemi** products, including compliance with all laws, regulations and safety requirements or standards, regardless of any support or applications information provided by **onsemi**. "Typical" parameters which may be provided in **onsemi** data sheets and/or specifications can and do vary in different applications and actual performance may vary over time. All operating parameters, including "Typicals" must be validated for each customer application by customer's technical experts. **onsemi** does not convey any license under any of its intellectual property rights nor the rights of others. **onsemi** products are not designed, intended, or authorized for use as a critical component in life support systems or any FDA Class 3 medical devices or medical devices with a same or similar classification in a foreign jurisdiction or any devices intended for implantation in the human body. Should Buyer purchase or use **onsemi** products for any such unintended or unauthorized application, Buyer shall indemnify and hold **onsemi** and its officers, employees, subsidiaries, affiliates, and distributors harmless against all claims, costs, damages, and expenses, and reasonable attorney fees arising out of, directly or indirectly, any claim of personal injury or death associated with such unintended or unauthorized use, even if such claim alleges that **onsemi** was negligent regarding the design or manufacture of the part. **onsemi** is an Equal Opportunity/Affirmative Action Employer. This literature is subject to all applicable copyright laws and is not for resale in any manner. Other names and brands may be claimed as the property of others.

# 2N6426, 2N6427

2N6426 is a Preferred Device

## Darlington Transistors

### NPN Silicon

#### Features

- These are Pb-Free Devices\*

#### MAXIMUM RATINGS

Rating	Symbol	Value	Unit
Collector – Emitter Voltage	$V_{CEO}$	40	Vdc
Collector – Base Voltage	$V_{CBO}$	40	Vdc
Emitter – Base Voltage	$V_{EBO}$	12	Vdc
Collector Current – Continuous	$I_C$	500	mAdc
Total Device Dissipation @ $T_A = 25^\circ\text{C}$ Derate above $25^\circ\text{C}$	$P_D$	625 5.0	mW mW/ $^\circ\text{C}$
Total Device Dissipation @ $T_C = 25^\circ\text{C}$ Derate above $25^\circ\text{C}$	$P_D$	1.5 12	W mW/ $^\circ\text{C}$
Operating and Storage Junction Temperature Range	$T_J, T_{stg}$	-55 to +150	$^\circ\text{C}$

#### THERMAL CHARACTERISTICS

Characteristic	Symbol	Max	Unit
Thermal Resistance, Junction-to-Ambient	$R_{\theta JA}$	200	$^\circ\text{C/W}$
Thermal Resistance, Junction-to-Case	$R_{\theta JC}$	83.3	$^\circ\text{C/W}$

Stresses exceeding Maximum Ratings may damage the device. Maximum Ratings are stress ratings only. Functional operation above the Recommended Operating Conditions is not implied. Extended exposure to stresses above the Recommended Operating Conditions may affect device reliability.



**ON Semiconductor®**

<http://onsemi.com>

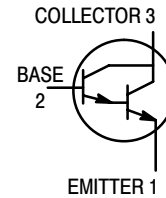

TO-92  
CASE 29  
STYLE 1

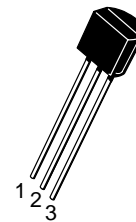

STRAIGHT LEAD  
BULK PACK

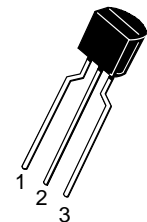

BENT LEAD  
TAPE & REEL  
AMMO PACK

#### MARKING DIAGRAM

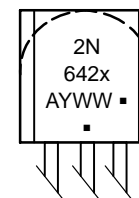

- x = 6 or 7
- A = Assembly Location
- Y = Year
- WW = Work Week
- = Pb-Free Package

(Note: Microdot may be in either location)

#### ORDERING INFORMATION

See detailed ordering and shipping information in the package dimensions section on page 5 of this data sheet.

**Preferred** devices are recommended choices for future use and best overall value.

\*For additional information on our Pb-Free strategy and soldering details, please download the ON Semiconductor Soldering and Mounting Techniques Reference Manual, SOLDERRM/D.

## 2N6426, 2N6427

### ELECTRICAL CHARACTERISTICS (T<sub>A</sub> = 25°C unless otherwise noted)

Characteristic	Symbol	Min	Typ	Max	Unit
<b>OFF CHARACTERISTICS</b>					
Collector–Emitter Breakdown Voltage, (Note 1) (I <sub>C</sub> = 10 mA <sub>dc</sub> , V <sub>BE</sub> = 0)	V <sub>(BR)CEO</sub>	40	–	–	V <sub>dc</sub>
Collector–Base Breakdown Voltage (I <sub>C</sub> = 100 μA <sub>dc</sub> , I <sub>E</sub> = 0)	V <sub>(BR)CBO</sub>	40	–	–	V <sub>dc</sub>
Emitter–Base Breakdown Voltage (I <sub>E</sub> = 10 μA <sub>dc</sub> , I <sub>C</sub> = 0)	V <sub>(BR)EBO</sub>	12	–	–	V <sub>dc</sub>
Collector Cutoff Current (V <sub>CE</sub> = 25 V <sub>dc</sub> , I <sub>B</sub> = 0)	I <sub>CES</sub>	–	–	1.0	μA <sub>dc</sub>
Collector Cutoff Current (V <sub>CB</sub> = 30 V <sub>dc</sub> , I <sub>E</sub> = 0)	I <sub>CBO</sub>	–	–	50	nA <sub>dc</sub>
Emitter Cutoff Current (V <sub>EB</sub> = 10 V <sub>dc</sub> , I <sub>C</sub> = 0)	I <sub>EBO</sub>	–	–	50	nA <sub>dc</sub>
<b>ON CHARACTERISTICS</b>					
DC Current Gain, (Note 1) (I <sub>C</sub> = 10 mA <sub>dc</sub> , V <sub>CE</sub> = 5.0 V <sub>dc</sub> )	h <sub>FE</sub>	20,000	–	200,000	–
	2N6426	10,000	–	100,000	
(I <sub>C</sub> = 100 mA <sub>dc</sub> , V <sub>CE</sub> = 5.0 V <sub>dc</sub> )	2N6426	30,000	–	300,000	
	2N6427	20,000	–	200,000	
(I <sub>C</sub> = 500 mA <sub>dc</sub> , V <sub>CE</sub> = 5.0 V <sub>dc</sub> )	2N6426	20,000	–	200,000	
	2N6427	14,000	–	140,000	
Collector–Emitter Saturation Voltage (I <sub>C</sub> = 50 mA <sub>dc</sub> , I <sub>B</sub> = 0.5 mA <sub>dc</sub> ) (I <sub>C</sub> = 500 mA <sub>dc</sub> , I <sub>B</sub> = 0.5 mA <sub>dc</sub> )	V <sub>CE(sat)</sub>	–	0.71 0.9	1.2 1.5	V <sub>dc</sub>
Base–Emitter Saturation Voltage (I <sub>C</sub> = 500 mA <sub>dc</sub> , I <sub>B</sub> = 0.5 mA <sub>dc</sub> )	V <sub>BE(sat)</sub>	–	1.52	2.0	V <sub>dc</sub>
Base–Emitter On Voltage (I <sub>C</sub> = 50 mA <sub>dc</sub> , V <sub>CE</sub> = 5.0 V <sub>dc</sub> )	V <sub>BE(on)</sub>	–	1.24	1.75	V <sub>dc</sub>
<b>SMALL–SIGNAL CHARACTERISTICS</b>					
Output Capacitance (V <sub>CB</sub> = 10 V <sub>dc</sub> , I <sub>E</sub> = 0, f = 1.0 MHz)	C <sub>obo</sub>	–	5.4	7.0	pF
Input Capacitance (V <sub>EB</sub> = 1.0 V <sub>dc</sub> , I <sub>C</sub> = 0, f = 1.0 MHz)	C <sub>ibo</sub>	–	10	15	pF
Input Impedance (I <sub>C</sub> = 10 mA <sub>dc</sub> , V <sub>CE</sub> = 5.0 V <sub>dc</sub> , f = 1.0 kHz)	h <sub>ie</sub>	100 50	– –	2000 1000	kΩ
Small–Signal Current Gain (I <sub>C</sub> = 10 mA <sub>dc</sub> , V <sub>CE</sub> = 5.0 V <sub>dc</sub> , f = 1.0 kHz)	h <sub>fe</sub>	20,000 10,000	– –	– –	–
Current–Gain – High Frequency (I <sub>C</sub> = 10 mA <sub>dc</sub> , V <sub>CE</sub> = 5.0 V <sub>dc</sub> , f = 100 MHz)	h <sub>fe</sub>	1.5 1.3	2.4 2.4	– –	–
Output Admittance (I <sub>C</sub> = 10 mA <sub>dc</sub> , V <sub>CE</sub> = 5.0 V <sub>dc</sub> , f = 1.0 kHz)	h <sub>oe</sub>	–	–	1000	μmhos
Noise Figure (I <sub>C</sub> = 1.0 mA <sub>dc</sub> , V <sub>CE</sub> = 5.0 V <sub>dc</sub> , R <sub>S</sub> = 100 kΩ, f = 1.0 kHz)	NF	–	3.0	10	dB

1. Pulse Test: Pulse Width ≤ 300 μs; Duty Cycle ≤ 2.0%.

# 2N6426, 2N6427

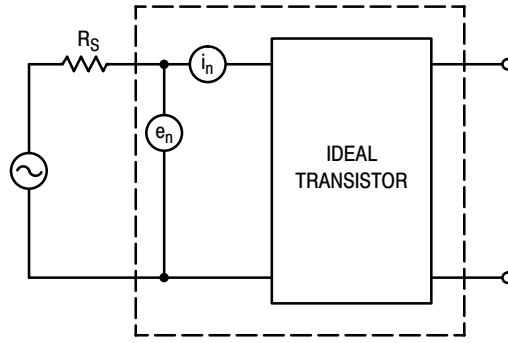

Figure 1. Transistor Noise Model

## NOISE CHARACTERISTICS

( $V_{CE} = 5.0$  Vdc,  $T_A = 25^\circ\text{C}$ )

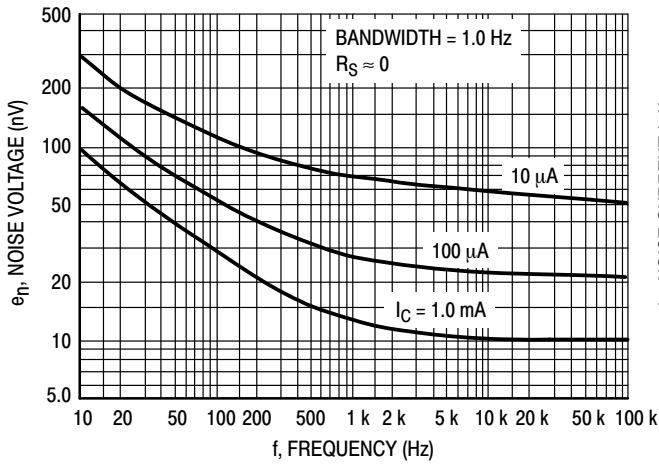

Figure 2. Noise Voltage

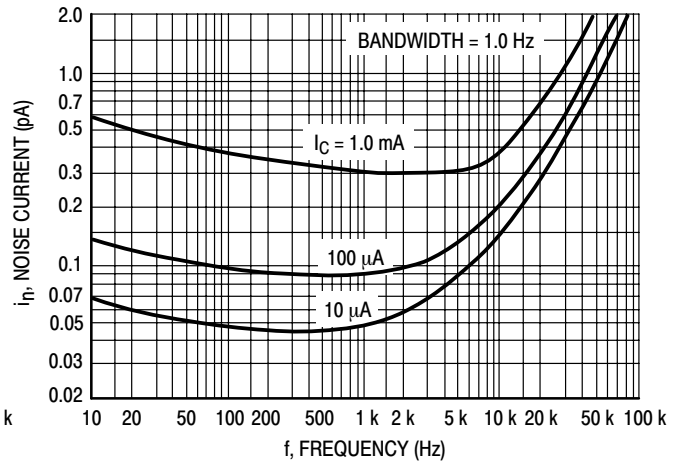

Figure 3. Noise Current

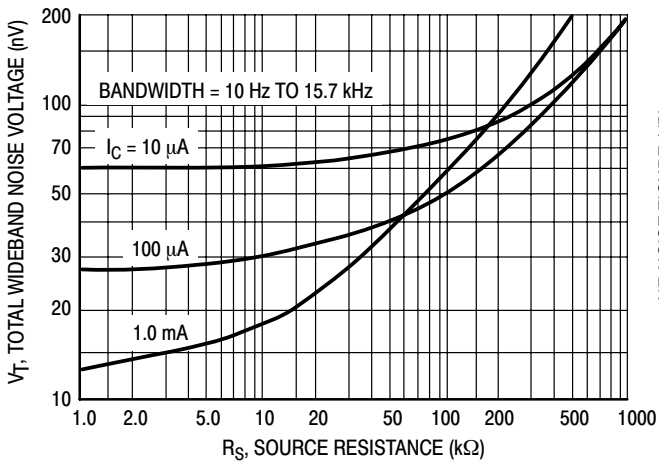

Figure 4. Total Wideband Noise Voltage

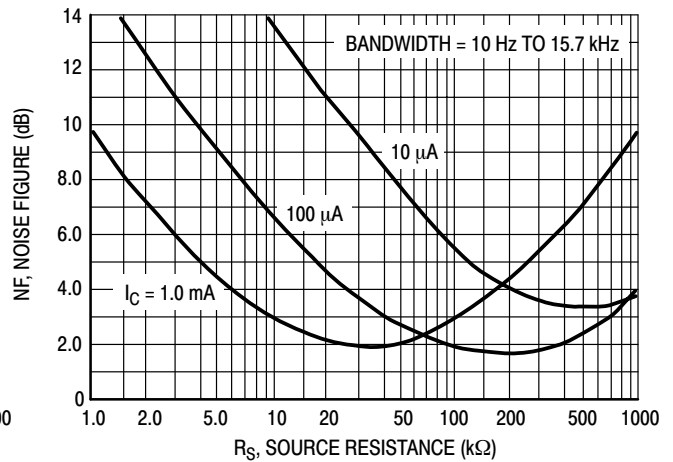

Figure 5. Wideband Noise Figure

SMALL-SIGNAL CHARACTERISTICS

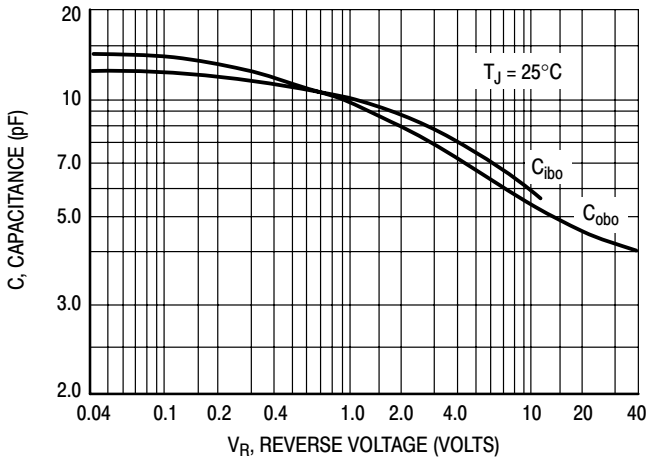

Figure 6. Capacitance

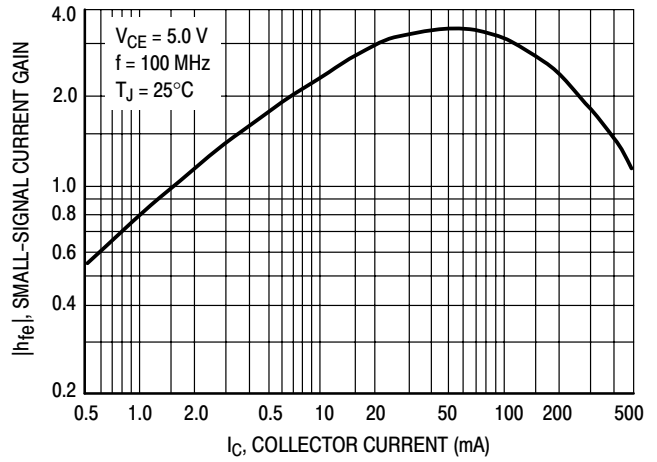

Figure 7. High Frequency Current Gain

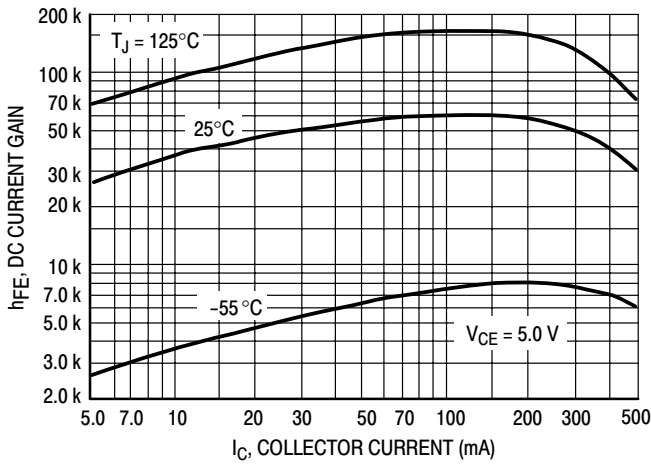

Figure 8. DC Current Gain

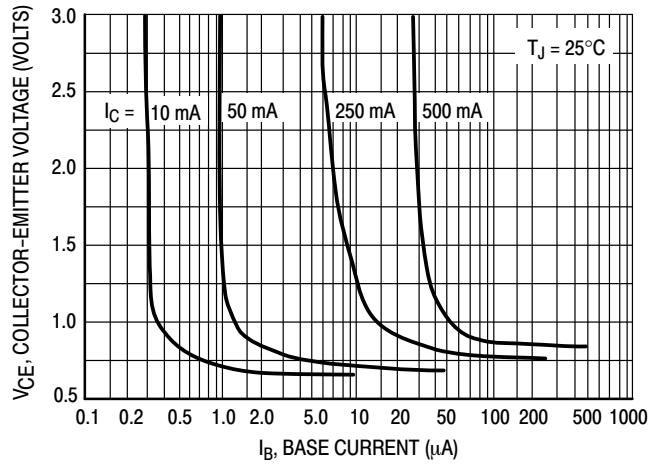

Figure 9. Collector Saturation Region

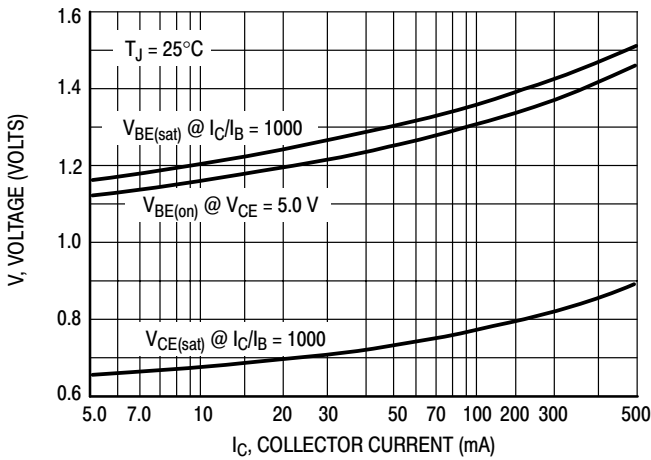

Figure 10. "On" Voltages

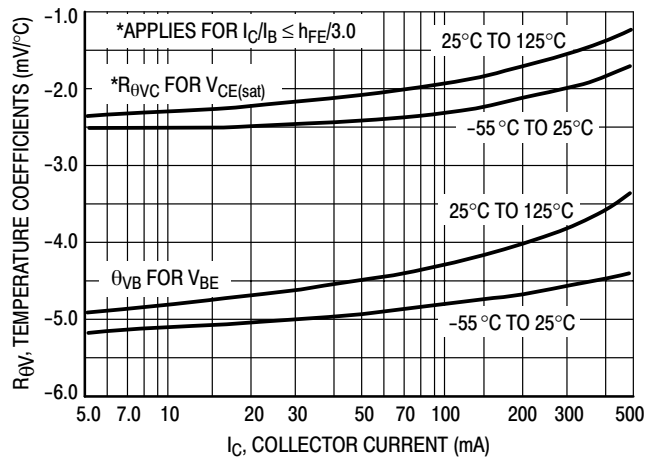
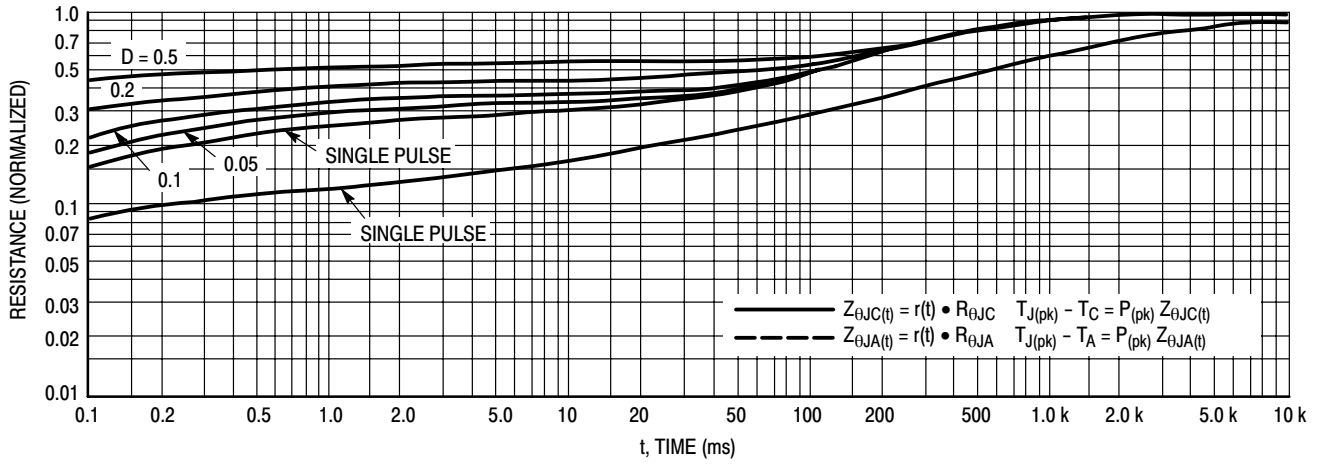
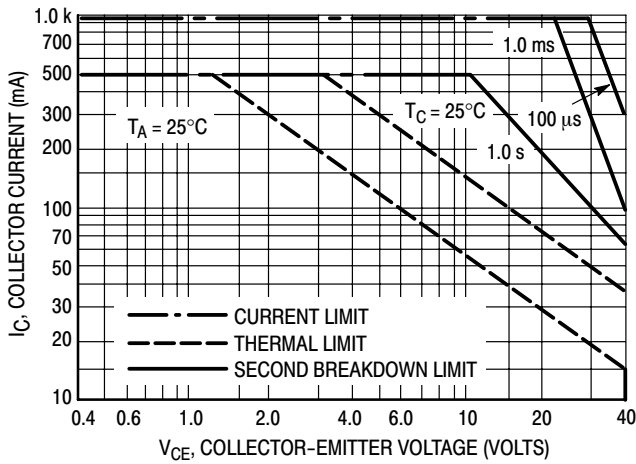

Figure 11. Temperature Coefficients

## 2N6426, 2N6427



**Figure 12. Thermal Response**



**Figure 13. Active Region Safe Operating Area**

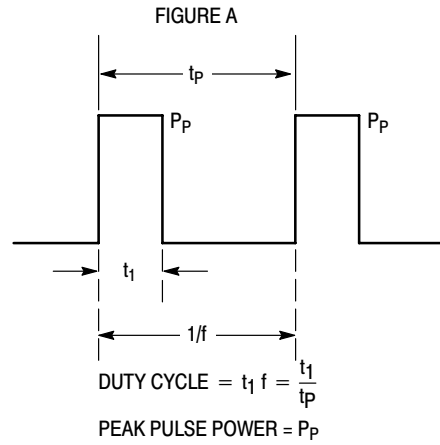

**Design Note: Use of Transient Thermal Resistance Data**

### ORDERING INFORMATION

Device	Package	Shipping†
2N6426G	TO-92 (Pb-Free)	5,000 Units / Bulk
2N6426RLRAG	TO-92 (Pb-Free)	2,000 / Tape & Ammo
2N6427G	TO-92 (Pb-Free)	5,000 Units / Bulk
2N6427RLRAG	TO-92 (Pb-Free)	2,000 / Tape & Ammo

†For information on tape and reel specifications, including part orientation and tape sizes, please refer to our Tape and Reel Packaging Specifications Brochure, BRD8011/D.

# 2N6426, 2N6427

## PACKAGE DIMENSIONS

### TO-92 (TO-226)

CASE 29-11

ISSUE AM

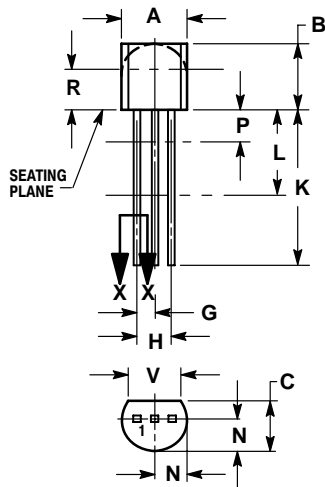

STRAIGHT LEAD  
BULK PACK

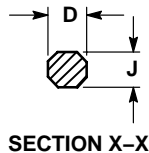

NOTES:

1. DIMENSIONING AND TOLERANCING PER ANSI Y14.5M, 1982.
2. CONTROLLING DIMENSION: INCH.
3. CONTOUR OF PACKAGE BEYOND DIMENSION R IS UNCONTROLLED.
4. LEAD DIMENSION IS UNCONTROLLED IN P AND BEYOND DIMENSION K MINIMUM.

DIM	INCHES		MILLIMETERS	
	MIN	MAX	MIN	MAX
A	0.175	0.205	4.45	5.20
B	0.170	0.210	4.32	5.33
C	0.125	0.165	3.18	4.19
D	0.016	0.021	0.407	0.533
G	0.045	0.055	1.15	1.39
H	0.095	0.105	2.42	2.66
J	0.015	0.020	0.39	0.50
K	0.500	---	12.70	---
L	0.250	---	6.35	---
N	0.080	0.105	2.04	2.66
P	---	0.100	---	2.54
R	0.115	---	2.93	---
V	0.135	---	3.43	---

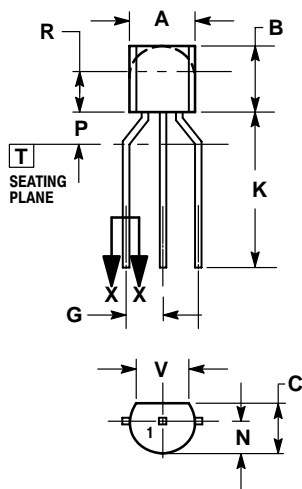

BENT LEAD  
TAPE & REEL  
AMMO PACK

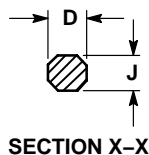

NOTES:

1. DIMENSIONING AND TOLERANCING PER ASME Y14.5M, 1994.
2. CONTROLLING DIMENSION: MILLIMETERS.
3. CONTOUR OF PACKAGE BEYOND DIMENSION R IS UNCONTROLLED.
4. LEAD DIMENSION IS UNCONTROLLED IN P AND BEYOND DIMENSION K MINIMUM.

DIM	MILLIMETERS	
	MIN	MAX
A	4.45	5.20
B	4.32	5.33
C	3.18	4.19
D	0.40	0.54
G	2.40	2.80
J	0.39	0.50
K	12.70	---
N	2.04	2.66
P	1.50	4.00
R	2.93	---
V	3.43	---

STYLE 1:

1. EMITTER
2. BASE
3. COLLECTOR

ON Semiconductor and are registered trademarks of Semiconductor Components Industries, LLC (SCILLC). SCILLC reserves the right to make changes without further notice to any products herein. SCILLC makes no warranty, representation or guarantee regarding the suitability of its products for any particular purpose, nor does SCILLC assume any liability arising out of the application or use of any product or circuit, and specifically disclaims any and all liability, including without limitation special, consequential or incidental damages. "Typical" parameters which may be provided in SCILLC data sheets and/or specifications can and do vary in different applications and actual performance may vary over time. All operating parameters, including "Typicals" must be validated for each customer application by customer's technical experts. SCILLC does not convey any license under its patent rights nor the rights of others. SCILLC products are not designed, intended, or authorized for use as components in systems intended for surgical implant into the body, or other applications intended to support or sustain life, or for any other application in which the failure of the SCILLC product could create a situation where personal injury or death may occur. Should Buyer purchase or use SCILLC products for any such unintended or unauthorized application, Buyer shall indemnify and hold SCILLC and its officers, employees, subsidiaries, affiliates, and distributors harmless against all claims, costs, damages, and expenses, and reasonable attorney fees arising out of, directly or indirectly, any claim of personal injury or death associated with such unintended or unauthorized use, even if such claim alleges that SCILLC was negligent regarding the design or manufacture of the part. SCILLC is an Equal Opportunity/Affirmative Action Employer. This literature is subject to all applicable copyright laws and is not for resale in any manner.

### PUBLICATION ORDERING INFORMATION

LITERATURE FULFILLMENT:

Literature Distribution Center for ON Semiconductor  
P.O. Box 5163, Denver, Colorado 80217 USA  
Phone: 303-675-2175 or 800-344-3860 Toll Free USA/Canada  
Fax: 303-675-2176 or 800-344-3867 Toll Free USA/Canada  
Email: orderlit@onsemi.com

N. American Technical Support: 800-282-9855 Toll Free  
USA/Canada  
Europe, Middle East and Africa Technical Support:  
Phone: 421 33 790 2910  
Japan Customer Focus Center  
Phone: 81-3-5773-3850

ON Semiconductor Website: [www.onsemi.com](http://www.onsemi.com)

Order Literature: <http://www.onsemi.com/orderlit>

For additional information, please contact your local Sales Representative