

NCP4328

Secondary Side CV/CC Controller

The NCP4328 is a secondary side SMPS controller designed for use in applications which requires constant current and/or constant current regulation.

The NCP4328x consists of two OTA amplifiers for voltage and current loop regulation with precise internal voltage references. Outputs of OTAs are open drain type (OTAs sink current only).

The NCP4328B includes a LED driver pin implemented with an open drain MOSFET driven by a 1 kHz square wave with a 12.5% duty cycle working when VCC is above UVLO for indication purpose.

The NCP4328A is available in TSOP-5 package while the NCP4328B is available in TSOP-6 package.

Features

- Operating Input Voltage Range: 2.5 V to 36.0 V
- Supply current < 100 μ A
- $\pm 0.5\%$ Reference Voltage Accuracy ($T_J = 25^\circ\text{C}$)
- Constant Voltage and Constant Current (A versions) Control Loop
- Indication LED PWM Modulated Driver (NCP4328B)
- These Devices are Pb-Free, Halogen Free/BFR Free and are RoHS Compliant

Typical Applications

- Offline Adapters for Notebooks, Game Stations and Printers
- LED Lightening
- High Power AC-DC Converters for TVs, Set-Top Boxes, Monitors etc.



ON Semiconductor®

www.onsemi.com

MARKING DIAGRAMS



TSOP-5
SN SUFFIX
CASE 483

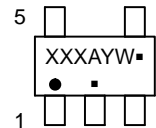

TSOP-6
SN SUFFIX
CASE 318G

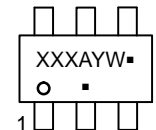

XXX = Specific Device Code
A = Assembly Location
Y = Year
W = Work Week
▪ = Pb-Free Package

(Note: Microdot may be in either location)

ORDERING INFORMATION

See detailed ordering, marking and shipping information on page 8 of this data sheet.

NCP4328

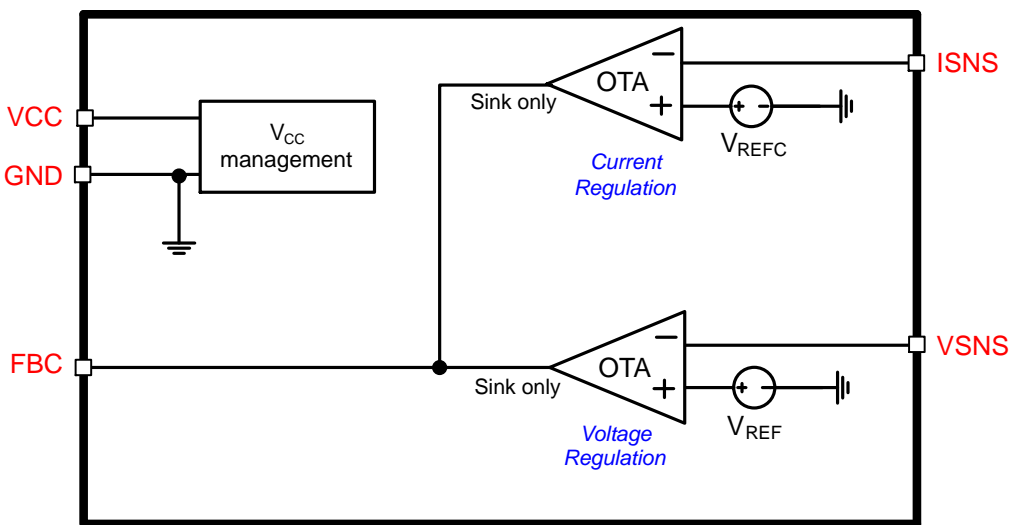

NCP4328A

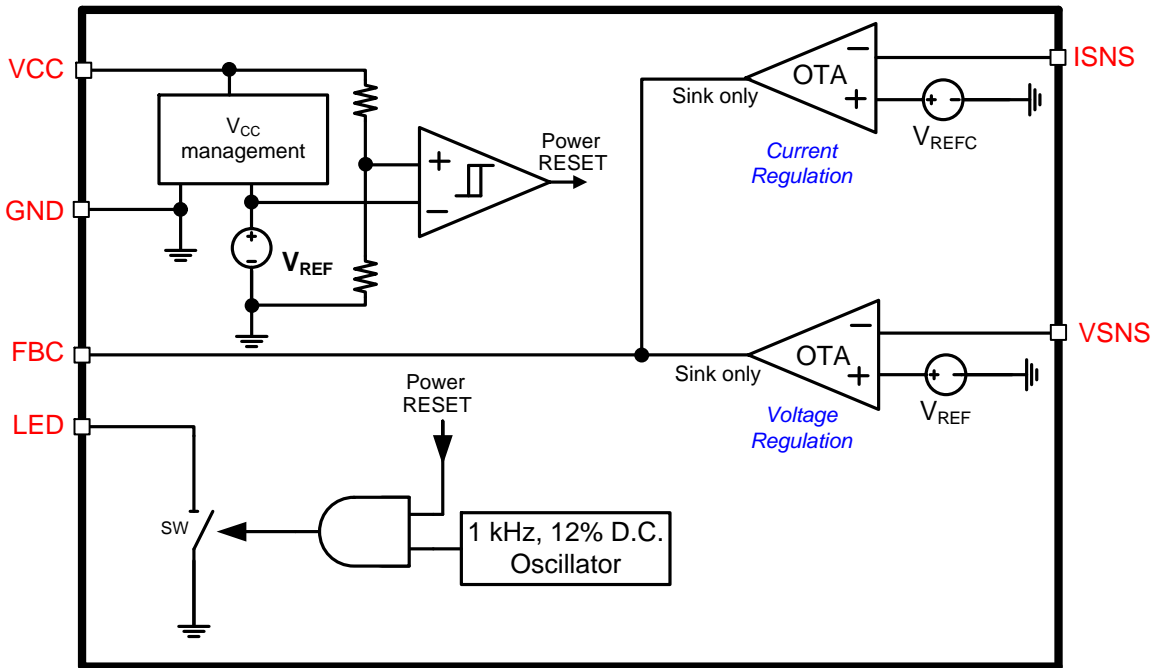

NCP4328B

Figure 1. Simplified Block Diagrams NCP4328A and NCP4328B

NCP4328

PIN FUNCTION DESCRIPTION

NCP4328A TSOP-5	NCP4328B TSOP-6	Pin Name	Description
1	1	VCC	Supply voltage pin
2	2	GND	Ground
5	6	VSNS	Output voltage sensing pin, connected to output voltage divider
4	4	ISNS	Current sensing input for output current regulation, connect it to shunt resistor in ground branch.
-	5	LED	PWM LED driver output. Connected to LED cathode with current define by external serial resistance
3	3	FBC	Output of current sinking OTA amplifiers driving feedback optocoupler's LED. Connect here compensation networks as well.

ABSOLUTE MAXIMUM RATINGS

Rating	Symbol	Value	Unit
Input Voltage	V_{CC}	-0.3 to 40.0	V
FBC, LED Voltage	V_{FBC}, V_{LED}	-0.3 to $V_{CC} + 0.3$	V
VSNS, ISNS Voltage	V_{SNS}, V_{ISNS}	-0.3 to 10.0	V
LED Current	I_{LED}	10	mA
Thermal Resistance – Junction-to-Air (Note 1)	$R_{\theta JA}$	315	°C/W
Junction Temperature	T_J	-40 to 150	°C
Storage Temperature	T_{STG}	-55 to 150	°C
ESD Capability, Human Body Model (Note 2)	ESD _{HBM}	2000	V
ESD Capability, Machine Model (Note 2)	ESD _{MM}	250	V

Stresses exceeding those listed in the Maximum Ratings table may damage the device. If any of these limits are exceeded, device functionality should not be assumed, damage may occur and reliability may be affected.

1. 50 mm², 1.0 oz. Copper spreader.

2. This device series incorporates ESD protection and is tested by the following methods:

ESD Human Body Model tested per JESD22-A114F

ESD Machine Model tested per JESD22-A115C

Latchup Current Maximum Rating tested per JEDEC standard: JESD78D.

NCP4328

ELECTRICAL CHARACTERISTICS

$-40^{\circ}\text{C} \leq T_J \leq 125^{\circ}\text{C}$; $V_{CC} = 15\text{ V}$; unless otherwise noted. Typical values are at $T_J = +25^{\circ}\text{C}$.

Parameter	Test Conditions	Symbol	Min	Typ	Max	Unit
Maximum Operating Input Voltage		V_{CC}			36.0	V
VCC UVLO	V_{CC} rising	V_{CCUVLO}	3.3	3.5	3.7	V
	V_{CC} falling		2.3	2.5	2.7	
VCC UVLO Hysteresis		$V_{CCUVLOHYS}$	0.8	1.0		V
Quiescent Current	NCP4328A	I_{CC}		105	130	μA
	NCP4328B			115	140	

VOLTAGE CONTROL LOOP OTA

Transconductance	Sink current only	gm_V		1		S
Reference Voltage	$2.8\text{ V} \leq V_{CC} \leq 36.0\text{ V}$, $T_J = 25^{\circ}\text{C}$	V_{REF}	1.244	1.250	1.256	V
	$2.8\text{ V} \leq V_{CC} \leq 36.0\text{ V}$, $T_J = 0 - 85^{\circ}\text{C}$		1.240	1.250	1.264	
	$2.8\text{ V} \leq V_{CC} \leq 36.0\text{ V}$, $T_J = -40 - 125^{\circ}\text{C}$		1.230	1.250	1.270	
Sink Current Capability	$V_{FBC} > 1.5\text{ V}$	I_{SINKV}	2.5			mA
Inverting Input Bias Current	$V_{SNS} = V_{REF}$	I_{BIASV}	-100		100	nA

CURRENT CONTROL LOOP OTA

Transconductance	Sink current only	gm_C		3		S
Reference Voltage	$T_J = 25^{\circ}\text{C}$	V_{REFC}	61.2	62.5	63.8	mV
	$T_J = -20 - 85^{\circ}\text{C}$		60.5	62.5	64.5	
	$T_J = -40 - 125^{\circ}\text{C}$		60.0	62.5	65.0	
Sink Current Capability	$V_{FBC} > 1.5\text{ V}$	I_{SINKC}	2.5			mA
Inverting Input Bias Current	$I_{SNS} = V_{REFC}$	I_{BIASC}	-100		100	nA

LED DRIVER (NCP4328B Only)

Switching Frequency		f_{SWLED}		1		kHz
Duty Cycle	(Note 3)	D_{LED}	10.0	12.5	15.0	%
Switch Resistance	$I_{LED} = 5\text{ mA}$	R_{SW}		50		Ω

Product parametric performance is indicated in the Electrical Characteristics for the listed test conditions, unless otherwise noted. Product performance may not be indicated by the Electrical Characteristics if operated under different conditions.

3. Guaranteed by design.

NCP4328

TYPICAL CHARACTERISTICS

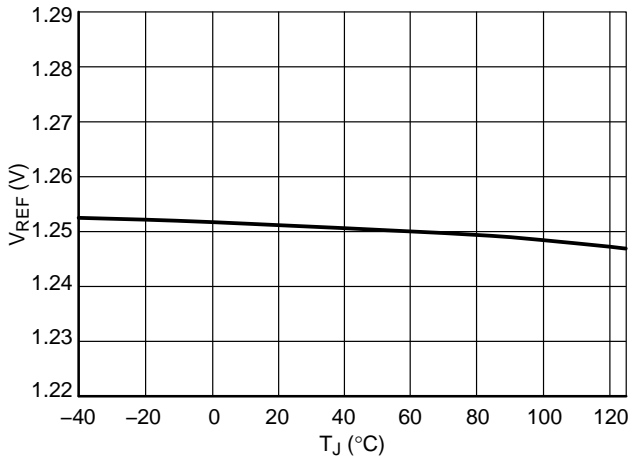

Figure 2. V_{REF} at V_{CC} = 15 V

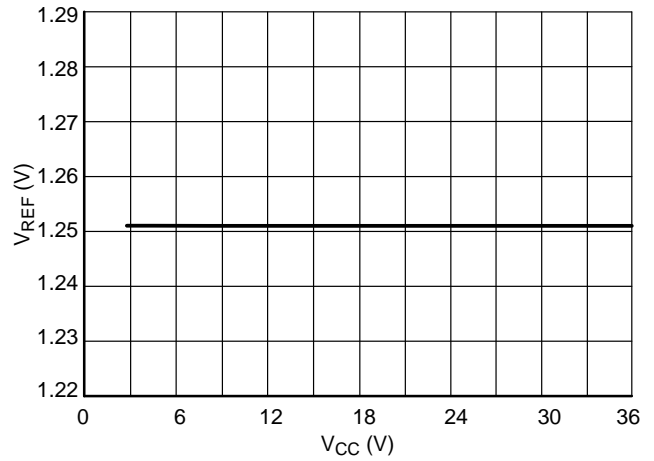

Figure 3. V_{REF} at T_J = 25°C

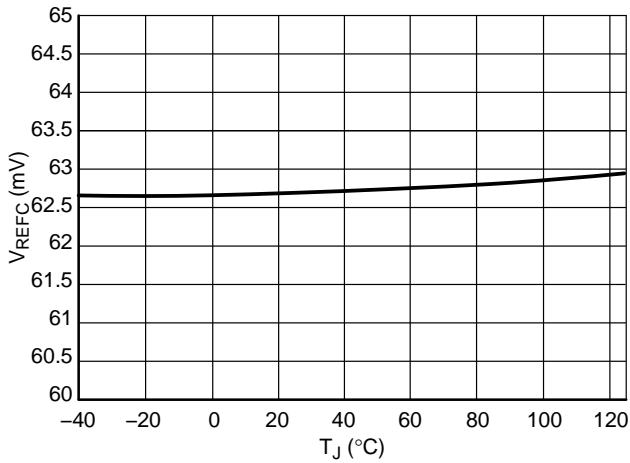

Figure 4. V_{REFC} at V_{CC} = 15 V

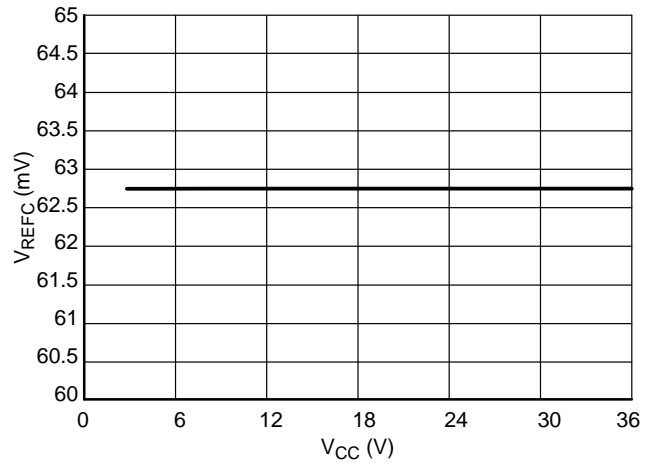

Figure 5. V_{REFC} at T_J = 25°C

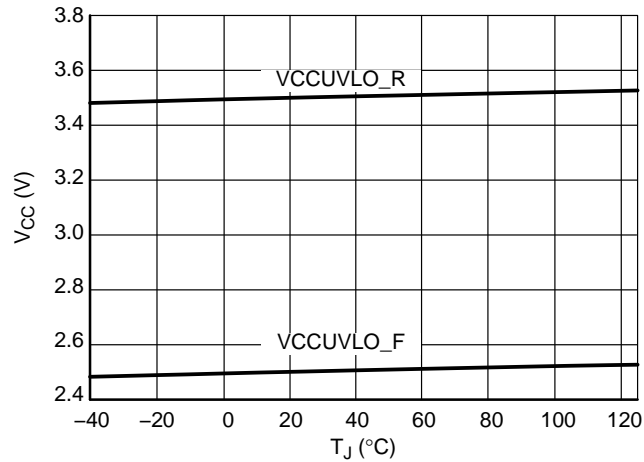

Figure 6. V_{CCUVLO}

NCP4328

TYPICAL CHARACTERISTICS

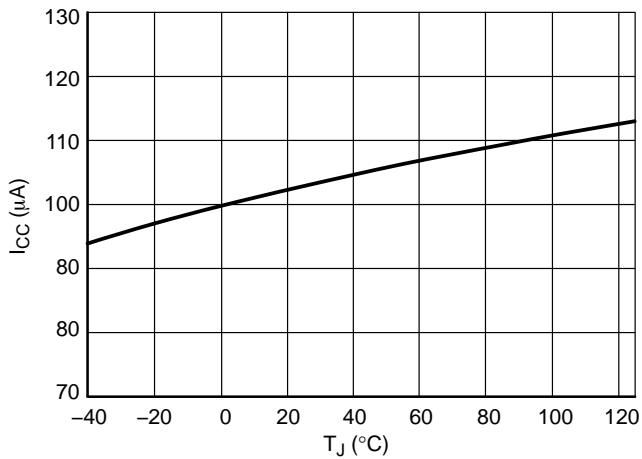

Figure 7. I_{CC} at $V_{CC} = 15 V$ for NCP4328A

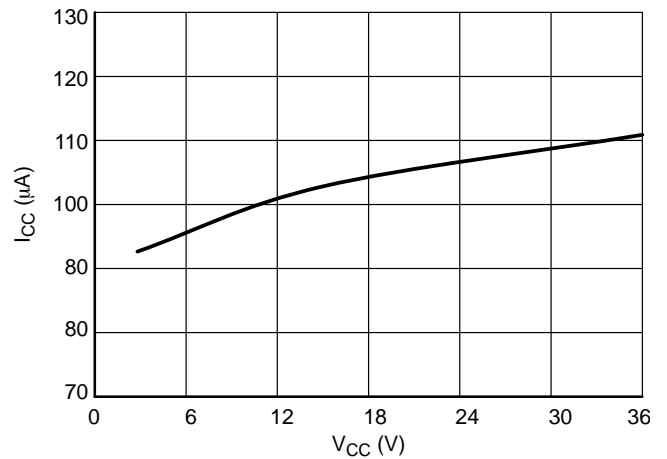

Figure 8. I_{CC} at $T_J = 25^{\circ}C$ for NCP4328A

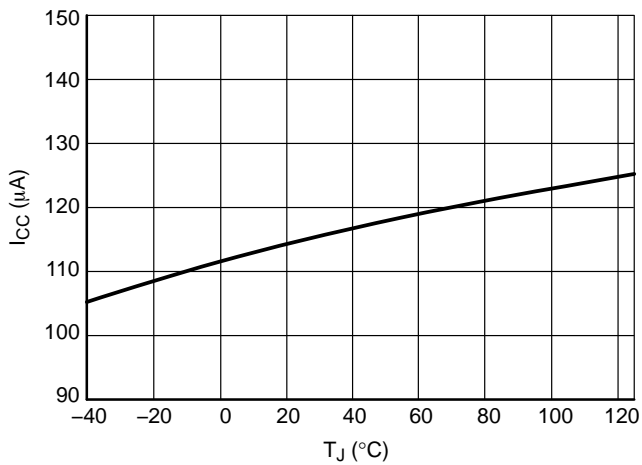

Figure 9. I_{CC} at $V_{CC} = 15 V$ for NCP4328B

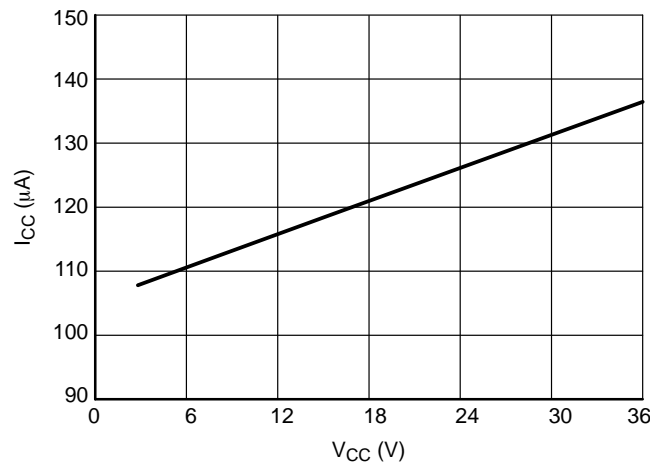

Figure 10. I_{CC} at $T_J = 25^{\circ}C$ for NCP4328B

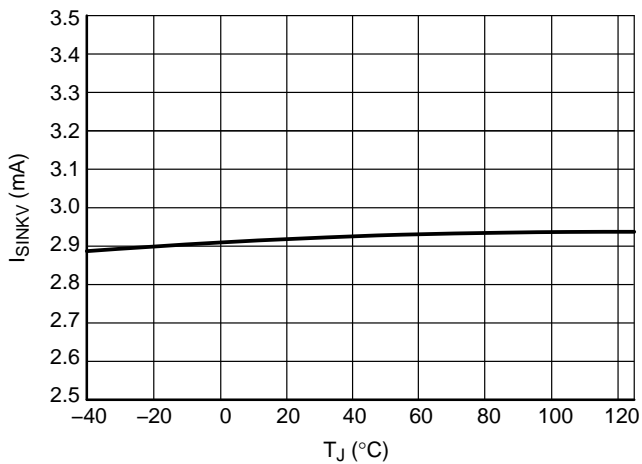

Figure 11. Voltage OTA Current Sink Capability

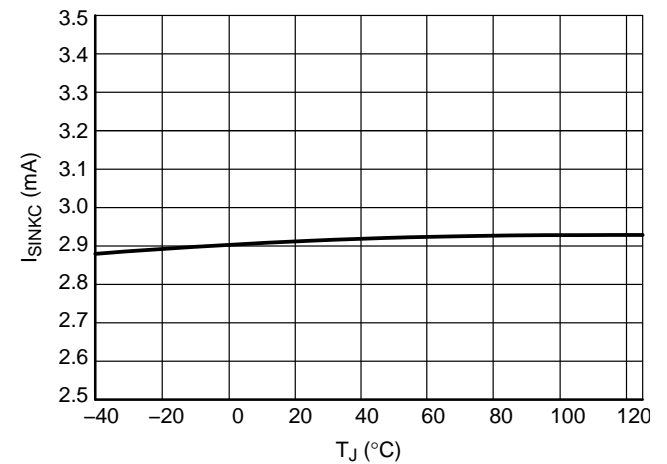

Figure 12. Current OTA Current Sink Capability

TYPICAL CHARACTERISTICS

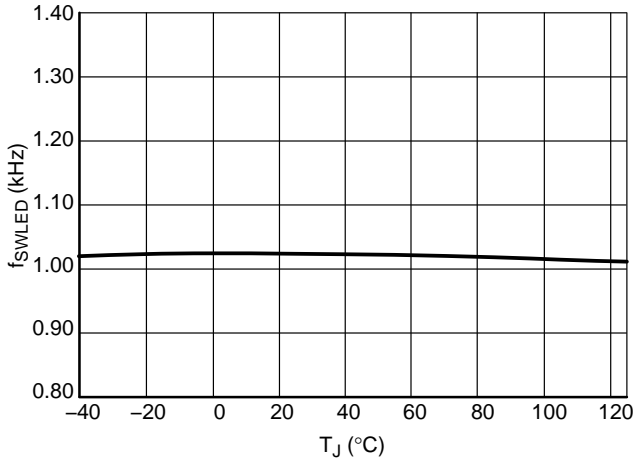

Figure 13. LED Switching Frequency at V_{CC} = 15 V

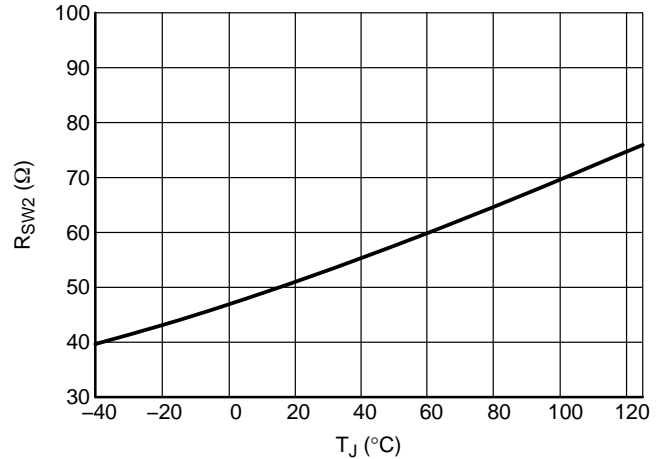

Figure 14. R_{SW} at V_{CC} = 15 V

APPLICATION INFORMATION

Typical application circuit for NCP4328A is shown in Figures 15 and 16 shows typical application circuit for NCP4328B that includes internal LED driver for indication purpose.

Power Supply

The NCP4328 is designed to operate from a single supply up to 36 V. It starts to operate when VCC voltage reaches 3.5 V and stops when VCC voltage drops below 2.5 V. VCC can be supplied by direct connection to the VOUT voltage of the power supply. It is highly recommended to add a RC filter (R1 and C2) in series from VOUT to VCC pin to reduce voltage spikes and drops that are produced at the converter’s output capacitors. Recommended values for this filter are 220 Ω and 1 μF.

Voltage Regulation Path

The output voltage is detected on the VSNS pin by the R3 and R4 voltage divider. This voltage is compared with the internal precise voltage reference. The voltage difference is amplified by gm_V of the transconductance amplifier. The amplifier output current is connected to the FBC pin. The compensation network is also connected to this pin to provide frequency compensation for the voltage regulation path. This FBC pin drives regulation optocoupler that provides regulation of primary side. The optocoupler is supplied via direct connection to VOUT line through resistor R2.

Regulation information is transferred through the optocoupler to the primary side controller where its FB pin is usually pulled down to reduce energy transferred to secondary output.

The output voltage can be computed by Equation 1.

$$V_{OUT} = V_{REF} \frac{R3 + R4}{R4} \quad (eq. 1)$$

Current Regulation

The output current is sensed by the shunt resistor R5 in series with the load. Voltage drop on R5 is compared with internal precise voltage reference V_{REFC} at I_{SN}S transconductance amplifier input.

Voltage difference is amplified by gm_C to output current of amplifier, connected to FBC pin. Compensation network is connected between this pin and I_{SN}S input to provide frequency compensation for current regulation path. Resistor R6 separates compensation network from sense resistor. Compensation network works into low impedance without this resistor that significantly decreases compensation network impact.

Current regulation point is set to current given by Equation 2.

$$I_{OUTLIM} = \frac{V_{REFC}}{R5} \quad (eq. 2)$$

LED Driver (NCP4328B only)

LED driver is active when VCC is higher than V_{CCMIN}. LED driver consists of an internal power switch controlled by a PWM modulated logic signal and an external current limiting resistor R9. LED current can be computed by Equation 3

$$I_{LED} = \frac{V_{OUT} - V_{F_LED}}{R9} \quad (eq. 3)$$

PWM modulation is used to increase efficiency of LED.

NCP4328

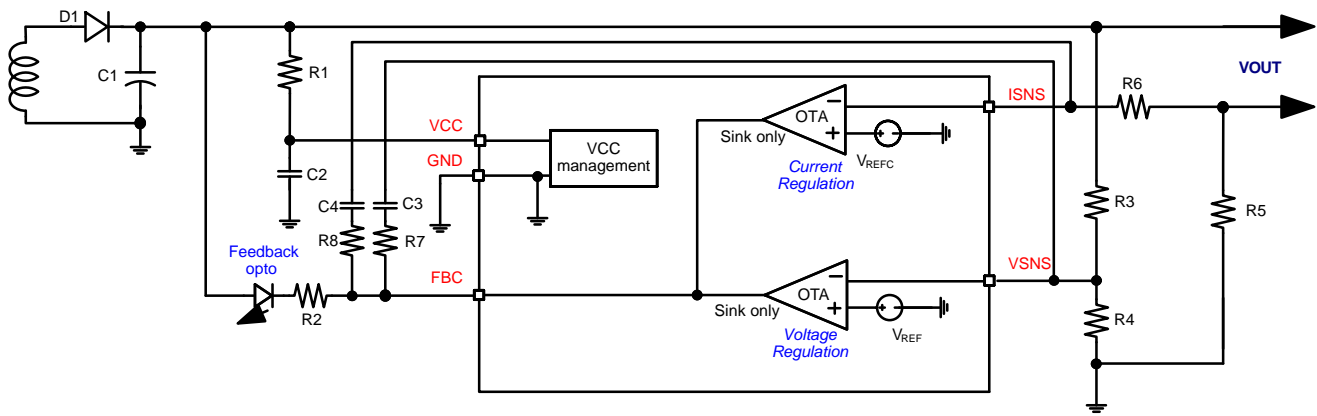

Figure 15. Typical Application Schematic for NCP4328A

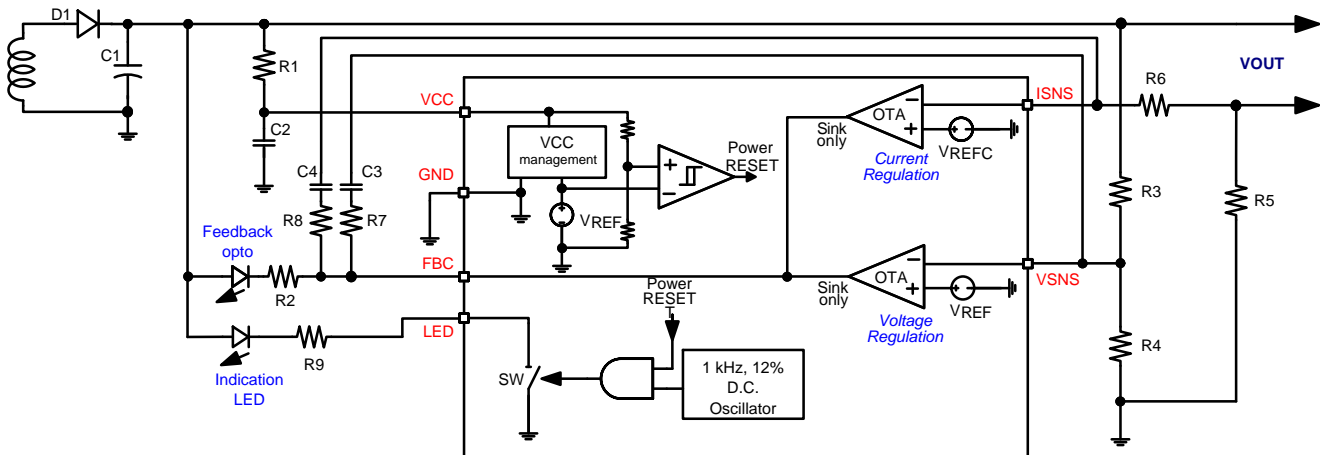

Figure 16. Typical Application Schematic for NCP4328B

ORDERING INFORMATION

Device	Marking	LED Driver	Package	Shipping†
NCP4328ASNT1G	A32	No	TSOP-5 (Pb-Free)	3000 / Tape & Reel
NCP4328BSNT1G	U32	Yes	TSOP-6 (Pb-Free)	3000 / Tape & Reel

†For information on tape and reel specifications, including part orientation and tape sizes, please refer to our Tape and Reel Packaging Specifications Brochure, BRD8011/D.

MECHANICAL CASE OUTLINE

PACKAGE DIMENSIONS

ON Semiconductor®



SCALE 2:1

TSOP-6 CASE 318G-02 ISSUE V

DATE 12 JUN 2012

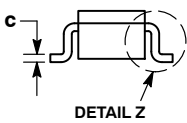
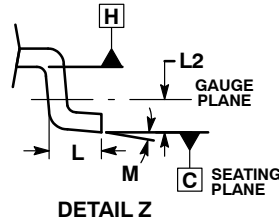
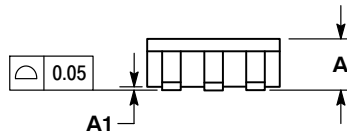
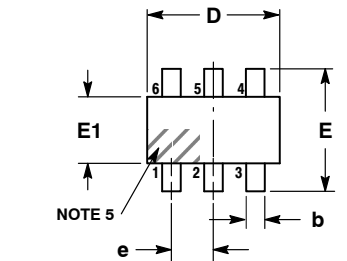

NOTES:

1. DIMENSIONING AND TOLERANCING PER ASME Y14.5M, 1994.
2. CONTROLLING DIMENSION: MILLIMETERS.
3. MAXIMUM LEAD THICKNESS INCLUDES LEAD FINISH. MINIMUM LEAD THICKNESS IS THE MINIMUM THICKNESS OF BASE MATERIAL.
4. DIMENSIONS D AND E1 DO NOT INCLUDE MOLD FLASH, PROTRUSIONS, OR GATE BURRS. MOLD FLASH, PROTRUSIONS, OR GATE BURRS SHALL NOT EXCEED 0.15 PER SIDE. DIMENSIONS D AND E1 ARE DETERMINED AT DATUM H.
5. PIN ONE INDICATOR MUST BE LOCATED IN THE INDICATED ZONE.

DIM	MILLIMETERS		
	MIN	NOM	MAX
A	0.90	1.00	1.10
A1	0.01	0.06	0.10
b	0.25	0.38	0.50
c	0.10	0.18	0.26
D	2.90	3.00	3.10
E	2.50	2.75	3.00
E1	1.30	1.50	1.70
e	0.85	0.95	1.05
L	0.20	0.40	0.60
L2	0.25 BSC		
M	0°	-	10°

- | | | | | | |
|--|--|---|---|---|--|
| <p>STYLE 1:
PIN 1. DRAIN
2. DRAIN
3. GATE
4. SOURCE
5. DRAIN
6. DRAIN</p> | <p>STYLE 2:
PIN 1. EMITTER 2
2. BASE 1
3. COLLECTOR 1
4. EMITTER 1
5. BASE 2
6. COLLECTOR 2</p> | <p>STYLE 3:
PIN 1. ENABLE
2. N/C
3. R BOOST
4. Vz
5. V in
6. V out</p> | <p>STYLE 4:
PIN 1. N/C
2. V in
3. NOT USED
4. GROUND
5. ENABLE
6. LOAD</p> | <p>STYLE 5:
PIN 1. EMITTER 2
2. BASE 2
3. COLLECTOR 1
4. EMITTER 1
5. BASE 1
6. COLLECTOR 2</p> | <p>STYLE 6:
PIN 1. COLLECTOR
2. COLLECTOR
3. BASE
4. EMITTER
5. COLLECTOR
6. COLLECTOR</p> |
| <p>STYLE 7:
PIN 1. COLLECTOR
2. COLLECTOR
3. BASE
4. N/C
5. COLLECTOR
6. EMITTER</p> | <p>STYLE 8:
PIN 1. Vbus
2. D(in)
3. D(in)+
4. D(out)+
5. D(out)
6. GND</p> | <p>STYLE 9:
PIN 1. LOW VOLTAGE GATE
2. DRAIN
3. SOURCE
4. DRAIN
5. DRAIN
6. HIGH VOLTAGE GATE</p> | <p>STYLE 10:
PIN 1. D(OUT)+
2. GND
3. D(OUT)-
4. D(IN)-
5. VBUS
6. D(IN)+</p> | <p>STYLE 11:
PIN 1. SOURCE 1
2. DRAIN 2
3. DRAIN 2
4. SOURCE 2
5. GATE 1
6. DRAIN 1/GATE 2</p> | <p>STYLE 12:
PIN 1. I/O
2. GROUND
3. I/O
4. I/O
5. VCC
6. I/O</p> |
| <p>STYLE 13:
PIN 1. GATE 1
2. SOURCE 2
3. GATE 2
4. DRAIN 2
5. SOURCE 1
6. DRAIN 1</p> | <p>STYLE 14:
PIN 1. ANODE
2. SOURCE
3. GATE
4. CATHODE/DRAIN
5. CATHODE/DRAIN
6. CATHODE/DRAIN</p> | <p>STYLE 15:
PIN 1. ANODE
2. SOURCE
3. GATE
4. DRAIN
5. N/C
6. CATHODE</p> | <p>STYLE 16:
PIN 1. ANODE/CATHODE
2. BASE
3. EMITTER
4. COLLECTOR
5. ANODE
6. CATHODE</p> | <p>STYLE 17:
PIN 1. EMITTER
2. BASE
3. ANODE/CATHODE
4. ANODE
5. CATHODE
6. COLLECTOR</p> | |

RECOMMENDED SOLDERING FOOTPRINT*

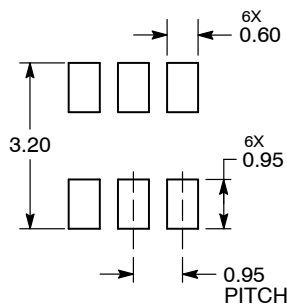

DIMENSIONS: MILLIMETERS

GENERIC MARKING DIAGRAM*



- | | |
|----------------------------|----------------------------|
| XXX = Specific Device Code | XXX = Specific Device Code |
| A = Assembly Location | M = Date Code |
| Y = Year | ○ = Pb-Free Package |
| W = Work Week | ■ = Pb-Free Package |
| ■ = Pb-Free Package | |

*For additional information on our Pb-Free strategy and soldering details, please download the ON Semiconductor Soldering and Mounting Techniques Reference Manual, SOLDERRM/D.

*This information is generic. Please refer to device data sheet for actual part marking. Pb-Free indicator, "G" or microdot "▪", may or may not be present.

DOCUMENT NUMBER:	98ASB14888C	Electronic versions are uncontrolled except when accessed directly from the Document Repository. Printed versions are uncontrolled except when stamped "CONTROLLED COPY" in red.
DESCRIPTION:	TSOP-6	PAGE 1 OF 1

ON Semiconductor and ON are trademarks of Semiconductor Components Industries, LLC dba ON Semiconductor or its subsidiaries in the United States and/or other countries. ON Semiconductor reserves the right to make changes without further notice to any products herein. ON Semiconductor makes no warranty, representation or guarantee regarding the suitability of its products for any particular purpose, nor does ON Semiconductor assume any liability arising out of the application or use of any product or circuit, and specifically disclaims any and all liability, including without limitation special, consequential or incidental damages. ON Semiconductor does not convey any license under its patent rights nor the rights of others.

MECHANICAL CASE OUTLINE PACKAGE DIMENSIONS

ON Semiconductor®

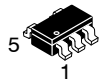

SCALE 2:1

TSOP-5 CASE 483 ISSUE N

DATE 12 AUG 2020

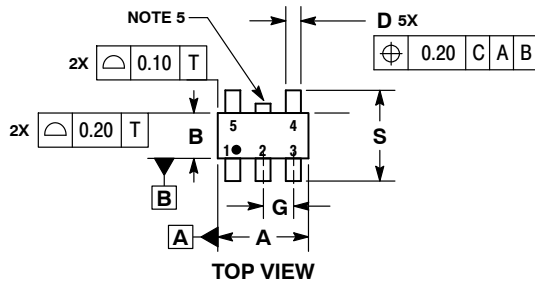

NOTES:

1. DIMENSIONING AND TOLERANCING PER ASME Y14.5M, 1994.
2. CONTROLLING DIMENSION: MILLIMETERS.
3. MAXIMUM LEAD THICKNESS INCLUDES LEAD FINISH THICKNESS. MINIMUM LEAD THICKNESS IS THE MINIMUM THICKNESS OF BASE MATERIAL.
4. DIMENSIONS A AND B DO NOT INCLUDE MOLD FLASH, PROTRUSIONS, OR GATE BURRS. MOLD FLASH, PROTRUSIONS, OR GATE BURRS SHALL NOT EXCEED 0.15 PER SIDE. DIMENSION A.
5. OPTIONAL CONSTRUCTION: AN ADDITIONAL TRIMMED LEAD IS ALLOWED IN THIS LOCATION. TRIMMED LEAD NOT TO EXTEND MORE THAN 0.2 FROM BODY.

DIM	MILLIMETERS	
	MIN	MAX
A	2.85	3.15
B	1.35	1.65
C	0.90	1.10
D	0.25	0.50
G	0.95 BSC	
H	0.01	0.10
J	0.10	0.26
K	0.20	0.60
M	0°	10°
S	2.50	3.00

SOLDERING FOOTPRINT*

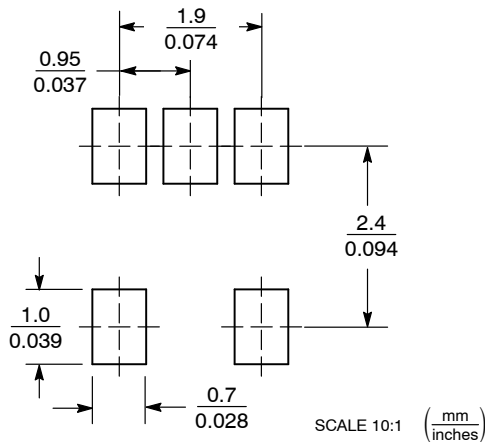

*For additional information on our Pb-Free strategy and soldering details, please download the ON Semiconductor Soldering and Mounting Techniques Reference Manual, SOLDERRM/D.

GENERIC MARKING DIAGRAM*

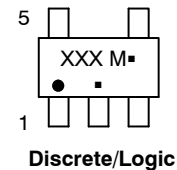
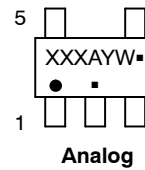

- XXX = Specific Device Code
 A = Assembly Location
 Y = Year
 W = Work Week
 ■ = Pb-Free Package
- XXX = Specific Device Code
 M = Date Code
 ■ = Pb-Free Package

(Note: Microdot may be in either location)

*This information is generic. Please refer to device data sheet for actual part marking. Pb-Free indicator, "G" or microdot "■", may or may not be present.

DOCUMENT NUMBER:	98ARB18753C	Electronic versions are uncontrolled except when accessed directly from the Document Repository. Printed versions are uncontrolled except when stamped "CONTROLLED COPY" in red.
DESCRIPTION:	TSOP-5	PAGE 1 OF 1

ON Semiconductor and ON are trademarks of Semiconductor Components Industries, LLC dba ON Semiconductor or its subsidiaries in the United States and/or other countries. ON Semiconductor reserves the right to make changes without further notice to any products herein. ON Semiconductor makes no warranty, representation or guarantee regarding the suitability of its products for any particular purpose, nor does ON Semiconductor assume any liability arising out of the application or use of any product or circuit, and specifically disclaims any and all liability, including without limitation special, consequential or incidental damages. ON Semiconductor does not convey any license under its patent rights nor the rights of others.

onsemi, **Onsemi**, and other names, marks, and brands are registered and/or common law trademarks of Semiconductor Components Industries, LLC dba "**onsemi**" or its affiliates and/or subsidiaries in the United States and/or other countries. **onsemi** owns the rights to a number of patents, trademarks, copyrights, trade secrets, and other intellectual property. A listing of **onsemi**'s product/patent coverage may be accessed at www.onsemi.com/site/pdf/Patent-Marking.pdf. **onsemi** reserves the right to make changes at any time to any products or information herein, without notice. The information herein is provided "as-is" and **onsemi** makes no warranty, representation or guarantee regarding the accuracy of the information, product features, availability, functionality, or suitability of its products for any particular purpose, nor does **onsemi** assume any liability arising out of the application or use of any product or circuit, and specifically disclaims any and all liability, including without limitation special, consequential or incidental damages. Buyer is responsible for its products and applications using **onsemi** products, including compliance with all laws, regulations and safety requirements or standards, regardless of any support or applications information provided by **onsemi**. "Typical" parameters which may be provided in **onsemi** data sheets and/or specifications can and do vary in different applications and actual performance may vary over time. All operating parameters, including "Typicals" must be validated for each customer application by customer's technical experts. **onsemi** does not convey any license under any of its intellectual property rights nor the rights of others. **onsemi** products are not designed, intended, or authorized for use as a critical component in life support systems or any FDA Class 3 medical devices or medical devices with a same or similar classification in a foreign jurisdiction or any devices intended for implantation in the human body. Should Buyer purchase or use **onsemi** products for any such unintended or unauthorized application, Buyer shall indemnify and hold **onsemi** and its officers, employees, subsidiaries, affiliates, and distributors harmless against all claims, costs, damages, and expenses, and reasonable attorney fees arising out of, directly or indirectly, any claim of personal injury or death associated with such unintended or unauthorized use, even if such claim alleges that **onsemi** was negligent regarding the design or manufacture of the part. **onsemi** is an Equal Opportunity/Affirmative Action Employer. This literature is subject to all applicable copyright laws and is not for resale in any manner.

PUBLICATION ORDERING INFORMATION

LITERATURE FULFILLMENT:

Email Requests to: orderlit@onsemi.com

onsemi Website: www.onsemi.com

TECHNICAL SUPPORT

North American Technical Support:

Voice Mail: 1 800-282-9855 Toll Free USA/Canada

Phone: 011 421 33 790 2910

Europe, Middle East and Africa Technical Support:

Phone: 00421 33 790 2910

For additional information, please contact your local Sales Representative