

NTLJD3115P

MOSFET – Power, Dual, P-Channel, WDFN 2X2 mm -20 V, -4.1 A

Features

- WDFN Package Provides Exposed Drain Pad for Excellent Thermal Conduction
- 2x2 mm Footprint Same as SC-88
- Lowest $R_{DS(on)}$ Solution in 2x2 mm Package
- 1.8 V $R_{DS(on)}$ Rating for Operation at Low Voltage Gate Drive Logic Level
- Low Profile (< 0.8 mm) for Easy Fit in Thin Environments
- Bidirectional Current Flow with Common Source Configuration
- This is a Pb-Free Device

Applications

- Optimized for Battery and Load Management Applications in Portable Equipment
- Li-Ion Battery Charging and Protection Circuits
- High Side Load Switch

MAXIMUM RATINGS ($T_J = 25^\circ\text{C}$ unless otherwise noted)

| Parameter | | Symbol | Value | Unit |
|---|------------------------|--------------------------|------------|------------------|
| Drain-to-Source Voltage | | V_{DSS} | -20 | V |
| Gate-to-Source Voltage | | V_{GS} | ± 8.0 | V |
| Continuous Drain Current (Note 1) | Steady State | $T_A = 25^\circ\text{C}$ | -3.3 | A |
| | | $T_A = 85^\circ\text{C}$ | -2.4 | |
| | $t \leq 5 \text{ s}$ | $T_A = 25^\circ\text{C}$ | -4.1 | |
| Power Dissipation (Note 1) | Steady State | $T_A = 25^\circ\text{C}$ | 1.5 | W |
| | | $t \leq 5 \text{ s}$ | 2.3 | |
| Continuous Drain Current (Note 2) | Steady State | $T_A = 25^\circ\text{C}$ | -2.3 | A |
| | | $T_A = 85^\circ\text{C}$ | -1.6 | |
| Power Dissipation (Note 2) | Steady State | $T_A = 25^\circ\text{C}$ | 0.71 | W |
| Pulsed Drain Current | $t_p = 10 \mu\text{s}$ | I_{DM} | -20 | A |
| Operating Junction and Storage Temperature | | T_J, T_{STG} | -55 to 150 | $^\circ\text{C}$ |
| Source Current (Body Diode) (Note 2) | | I_S | -1.9 | A |
| Lead Temperature for Soldering Purposes (1/8" from case for 10 s) | | T_L | 260 | $^\circ\text{C}$ |

Stresses exceeding those listed in the Maximum Ratings table may damage the device. If any of these limits are exceeded, device functionality should not be assumed, damage may occur and reliability may be affected.

1. Surface Mounted on FR4 Board using 1 in sq pad size (Cu area = 1.127 in sq [2 oz] including traces).
2. Surface Mounted on FR4 Board using the minimum recommended pad size of 30 mm², 2 oz Cu.



ON Semiconductor®

www.onsemi.com

| $V_{(BR)DSS}$ | $R_{DS(on)}$ MAX | I_D MAX (Note 1) |
|---------------|-------------------------|--------------------|
| -20 V | 100 m Ω @ -4.5 V | -4.1 A |
| | 135 m Ω @ -2.5 V | |
| | 200 m Ω @ -1.8 V | |

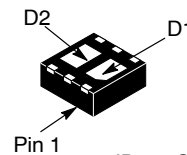
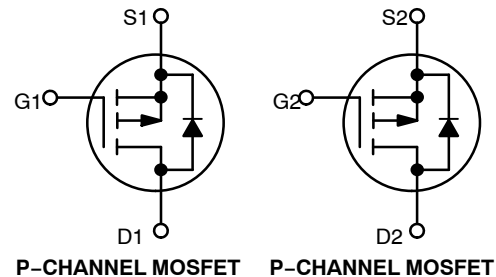

MARKING DIAGRAM



JD = Specific Device Code
M = Date Code
▪ = Pb-Free Package
(Note: Microdot may be in either location)

PIN CONNECTIONS

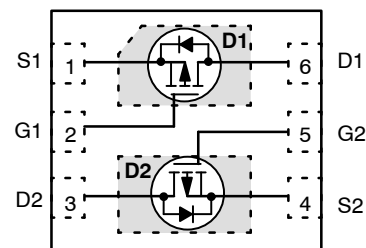

(Top View)

ORDERING INFORMATION

| Device | Package | Shipping† |
|---------------|-----------------|------------------|
| NTLJD3115PT1G | WDFN6 (Pb-Free) | 3000/Tape & Reel |
| NTLJD3115PTAG | WDFN6 (Pb-Free) | 3000/Tape & Reel |

†For information on tape and reel specifications, including part orientation and tape sizes, please refer to our Tape and Reel Packaging Specification Brochure, BRD8011/D.

NTLJD3115P

THERMAL RESISTANCE RATINGS

| Parameter | Symbol | Max | Unit |
|-----------|--------|-----|------|
|-----------|--------|-----|------|

SINGLE OPERATION (SELF-HEATED)

| | | | |
|---|-----------------|-----|------|
| Junction-to-Ambient – Steady State (Note 3) | $R_{\theta JA}$ | 83 | °C/W |
| Junction-to-Ambient – Steady State Min Pad (Note 4) | $R_{\theta JA}$ | 177 | |
| Junction-to-Ambient – $t \leq 5$ s (Note 3) | $R_{\theta JA}$ | 54 | |

DUAL OPERATION (EQUALLY HEATED)

| | | | |
|---|-----------------|-----|------|
| Junction-to-Ambient – Steady State (Note 3) | $R_{\theta JA}$ | 58 | °C/W |
| Junction-to-Ambient – Steady State Min Pad (Note 4) | $R_{\theta JA}$ | 133 | |
| Junction-to-Ambient – $t \leq 5$ s (Note 3) | $R_{\theta JA}$ | 40 | |

3. Surface Mounted on FR4 Board using 1 in sq pad size (Cu area = 1.127 in sq [2 oz] including traces).
4. Surface Mounted on FR4 Board using the minimum recommended pad size (30 mm², 2 oz Cu).

NTLJD3115P

MOSFET ELECTRICAL CHARACTERISTICS ($T_J = 25^\circ\text{C}$ unless otherwise noted)

| Parameter | Symbol | Test Conditions | Min | Typ | Max | Unit |
|---|-------------------|---|--------------------------|------|-----------|----------------------------|
| OFF CHARACTERISTICS | | | | | | |
| Drain-to-Source Breakdown Voltage | $V_{(BR)DSS}$ | $V_{GS} = 0\text{ V}, I_D = -250\ \mu\text{A}$ | -20 | | | V |
| Drain-to-Source Breakdown Voltage Temperature Coefficient | $V_{(BR)DSS}/T_J$ | $I_D = -250\ \mu\text{A}$, Ref to 25°C | | 9.95 | | $\text{mV}/^\circ\text{C}$ |
| Zero Gate Voltage Drain Current | I_{DSS} | $V_{DS} = -16\text{ V}, V_{GS} = 0\text{ V}$ | $T_J = 25^\circ\text{C}$ | | -1.0 | μA |
| | | | $T_J = 85^\circ\text{C}$ | | -10 | |
| Gate-to-Source Leakage Current | I_{GSS} | $V_{DS} = 0\text{ V}, V_{GS} = \pm 8.0\text{ V}$ | | | ± 100 | nA |

ON CHARACTERISTICS (Note 5)

| | | | | | | |
|---|------------------|---|------|------|------|----------------------------|
| Gate Threshold Voltage | $V_{GS(TH)}$ | $V_{GS} = V_{DS}, I_D = -250\ \mu\text{A}$ | -0.4 | -0.7 | -1.0 | V |
| Negative Gate Threshold Temperature Coefficient | $V_{GS(TH)}/T_J$ | | | 2.44 | | $\text{mV}/^\circ\text{C}$ |
| Drain-to-Source On-Resistance | $R_{DS(on)}$ | $V_{GS} = -4.5, I_D = -2.0\text{ A}$ | | 75 | 100 | m Ω |
| | | $V_{GS} = -2.5, I_D = -2.0\text{ A}$ | | 101 | 135 | |
| | | $V_{GS} = -1.8, I_D = -1.6\text{ A}$ | | 150 | 200 | |
| Forward Transconductance | g_{FS} | $V_{DS} = -5.0\text{ V}, I_D = -2.0\text{ A}$ | | 6.0 | | S |

CHARGES, CAPACITANCES AND GATE RESISTANCE

| | | | | | | |
|------------------------------|--------------|--|--|-----|-----|----|
| Input Capacitance | C_{ISS} | $V_{GS} = 0\text{ V}, f = 1.0\text{ MHz}, V_{DS} = -10\text{ V}$ | | 531 | | pF |
| Output Capacitance | C_{OSS} | | | 91 | | |
| Reverse Transfer Capacitance | C_{RSS} | | | 56 | | |
| Total Gate Charge | $Q_{G(TOT)}$ | $V_{GS} = -4.5\text{ V}, V_{DS} = -10\text{ V}, I_D = -2.0\text{ A}$ | | 5.5 | 6.2 | nC |
| Threshold Gate Charge | $Q_{G(TH)}$ | | | 0.7 | | |
| Gate-to-Source Charge | Q_{GS} | | | 1.0 | | |
| Gate-to-Drain Charge | Q_{GD} | | | 1.4 | | |
| Gate Resistance | R_G | | | 8.8 | | |

SWITCHING CHARACTERISTICS (Note 6)

| | | | | | | |
|---------------------|--------------|--|--|-----|--|----|
| Turn-On Delay Time | $t_{d(ON)}$ | $V_{GS} = -4.5\text{ V}, V_{DD} = -5.0\text{ V}, I_D = -1.0\text{ A}, R_G = 6.0\ \Omega$ | | 6.0 | | ns |
| Rise Time | t_r | | | 11 | | |
| Turn-Off Delay Time | $t_{d(OFF)}$ | | | 21 | | |
| Fall Time | t_f | | | 8.0 | | |
| Turn-On Delay Time | $t_{d(ON)}$ | $V_{GS} = -4.5\text{ V}, V_{DD} = -10\text{ V}, I_D = -2.0\text{ A}, R_G = 2.0\ \Omega$ | | 6.0 | | ns |
| Rise Time | t_r | | | 12 | | |
| Turn-Off Delay Time | $t_{d(OFF)}$ | | | 19 | | |
| Fall Time | t_f | | | 6.0 | | |

DRAIN-SOURCE DIODE CHARACTERISTICS

| | | | | | | | |
|--------------------------|----------|--|---------------------------|--|-------|------|----|
| Forward Recovery Voltage | V_{SD} | $V_{GS} = 0\text{ V}, I_S = -1.0\text{ A}$ | $T_J = 25^\circ\text{C}$ | | -0.75 | -1.0 | V |
| | | | $T_J = 125^\circ\text{C}$ | | -0.64 | | |
| Reverse Recovery Time | t_{RR} | $V_{GS} = 0\text{ V}, d_{ISD}/d_t = 100\text{ A}/\mu\text{s}, I_S = -1.0\text{ A}$ | | | 12.6 | | ns |
| Charge Time | t_a | | | | 7.0 | | |
| Discharge Time | t_b | | | | 5.6 | | |
| Reverse Recovery Time | Q_{RR} | | | | 5.0 | | |

5. Pulse Test: Pulse Width $\leq 300\ \mu\text{s}$, Duty Cycle $\leq 2\%$.

6. Switching characteristics are independent of operating junction temperatures.

TYPICAL PERFORMANCE CURVES ($T_J = 25^\circ\text{C}$ unless otherwise noted)

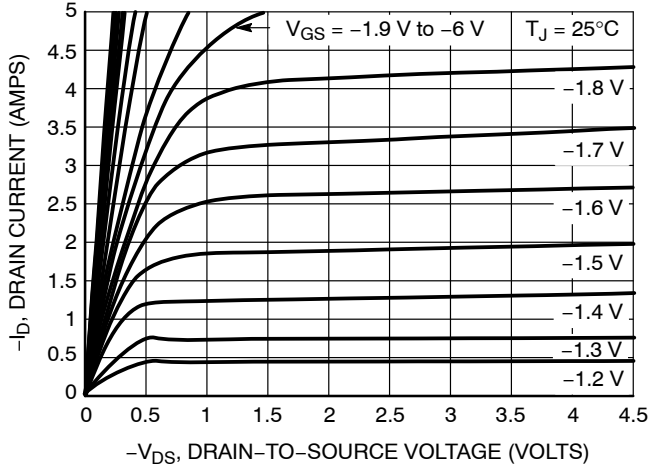

Figure 1. On-Region Characteristics

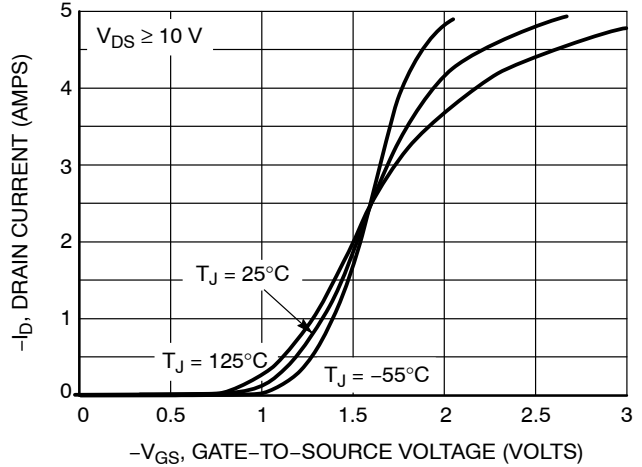

Figure 2. Transfer Characteristics

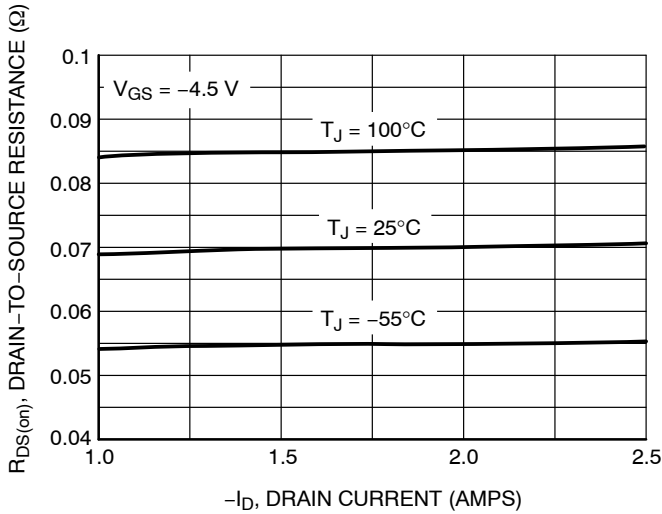

Figure 3. On-Resistance versus Drain Current

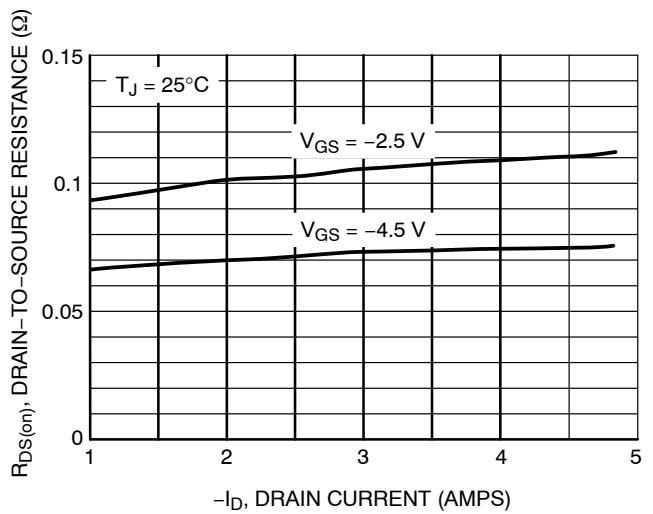

Figure 4. On-Resistance versus Drain Current and Gate Voltage

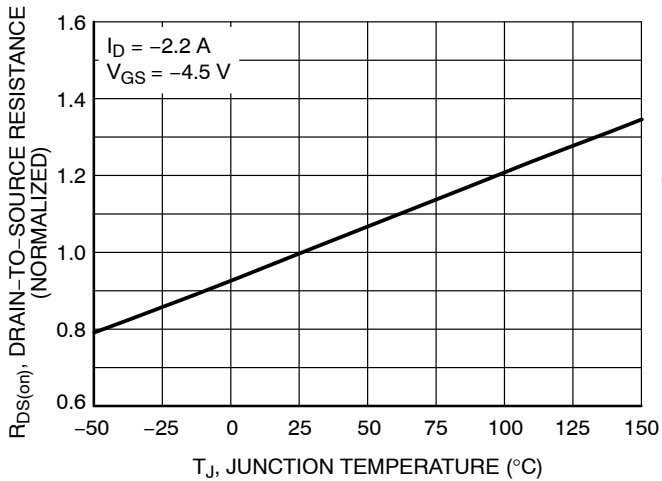

Figure 5. On-Resistance Variation with Temperature

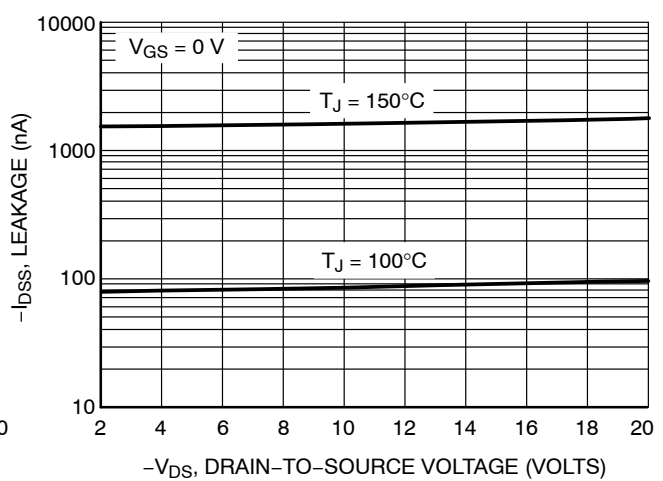

Figure 6. Drain-to-Source Leakage Current versus Voltage

TYPICAL PERFORMANCE CURVES ($T_J = 25^\circ\text{C}$ unless otherwise noted)

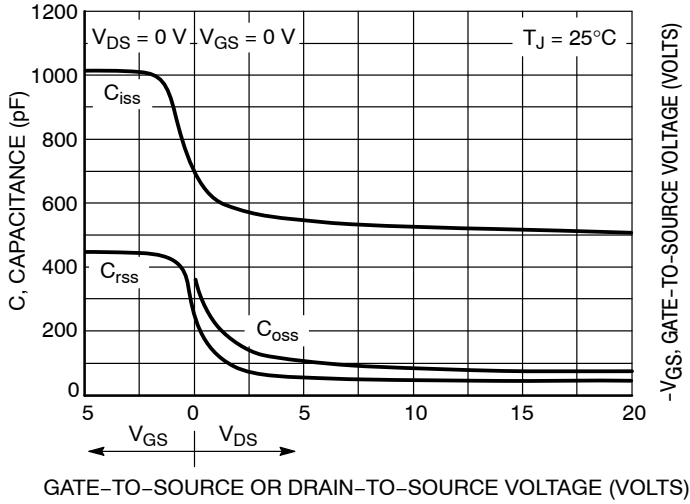

Figure 7. Capacitance Variation

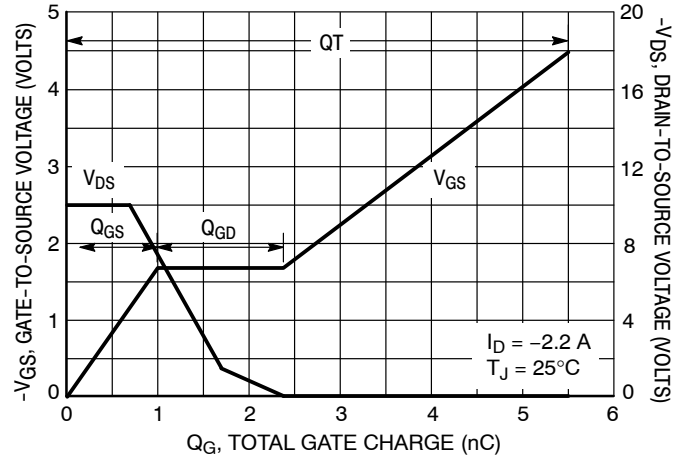

Figure 8. Gate-To-Source and Drain-To-Source Voltage versus Total Charge

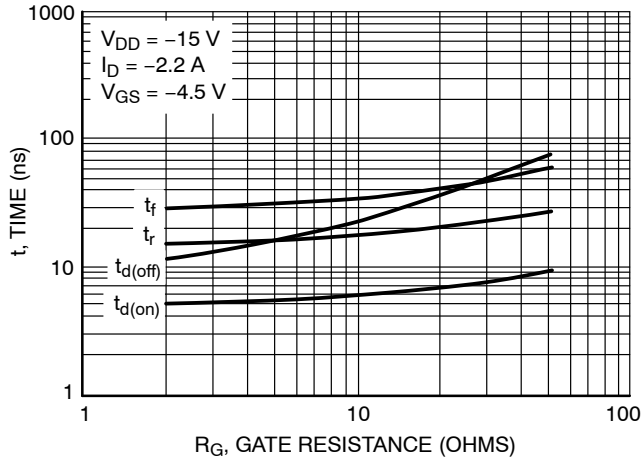

Figure 9. Resistive Switching Time Variation versus Gate Resistance

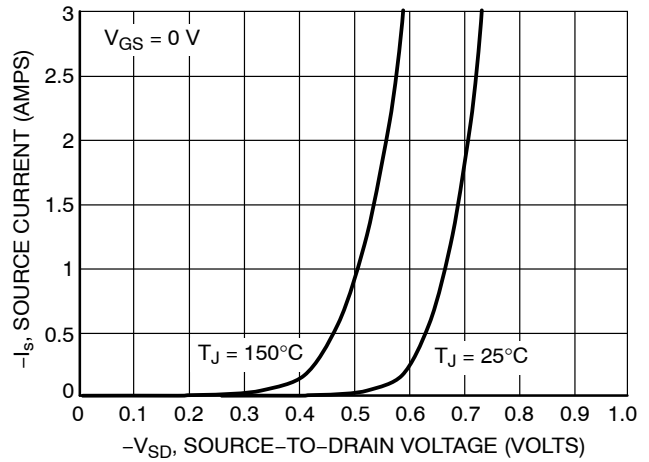

Figure 10. Diode Forward Voltage versus Current

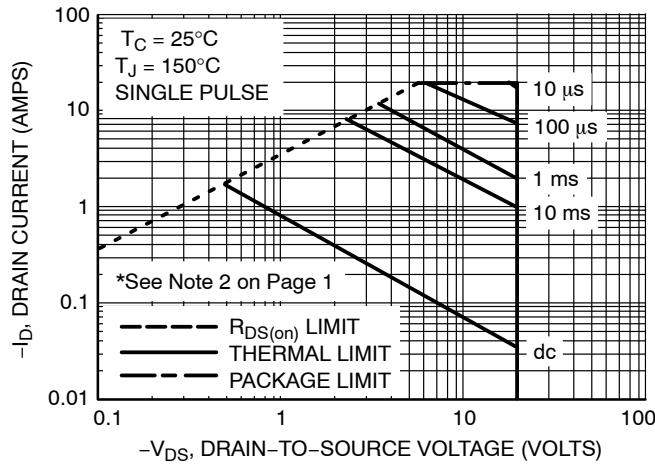

Figure 11. Maximum Rated Forward Biased Safe Operating Area

NTLJD3115P

TYPICAL PERFORMANCE CURVES ($T_J = 25^\circ\text{C}$ unless otherwise noted)

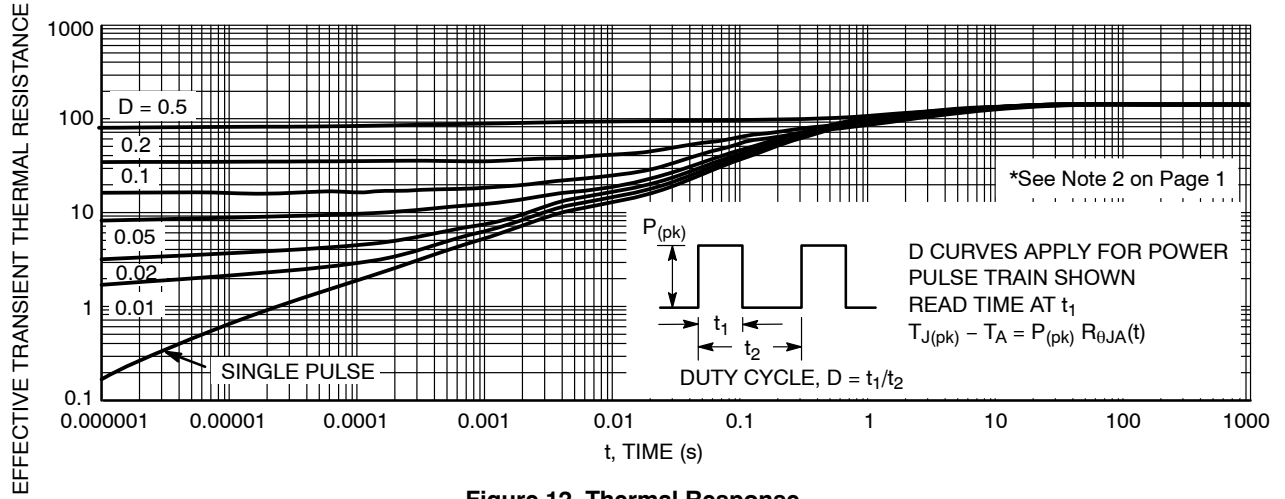
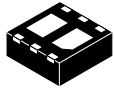

Figure 12. Thermal Response

MECHANICAL CASE OUTLINE PACKAGE DIMENSIONS



WDFN6 2x2, 0.65P
CASE 506AN
ISSUE H

DATE 25 JAN 2022

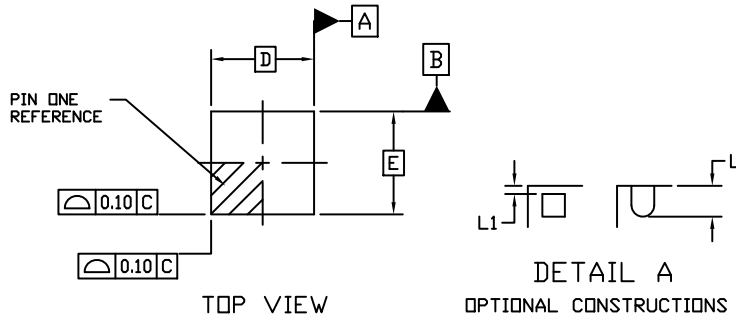

NOTES:

1. DIMENSIONING AND TOLERANCING PER ASME Y14.5M, 1994.
2. CONTROLLING DIMENSION: MILLIMETERS
3. DIMENSION **b** APPLIES TO PLATED TERMINAL AND IS MEASURED BETWEEN 0.15 AND 0.30 MM FROM THE TERMINAL TIP.
4. COPLANARITY APPLIES TO THE EXPOSED PADS AS WELL AS THE TERMINALS.

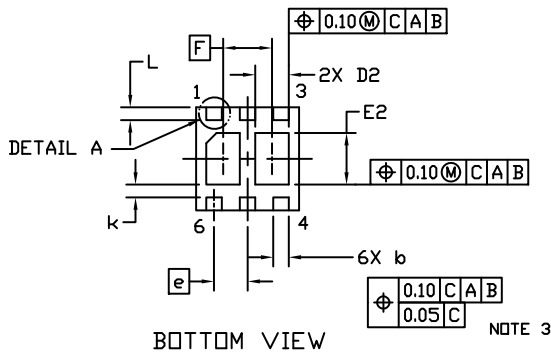
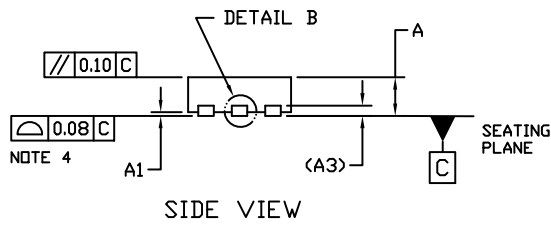

| DIM | MILLIMETERS | |
|-----|-------------|------|
| | MIN. | MAX. |
| A | 0.70 | 0.80 |
| A1 | 0.00 | 0.05 |
| A3 | 0.20 REF | |
| b | 0.25 | 0.35 |
| D | 2.00 BSC | |
| D2 | 0.57 | 0.77 |
| E | 2.00 BSC | |
| E2 | 0.90 | 1.10 |
| e | 0.65 BSC | |
| F | 0.95 BSC | |
| k | 0.25 REF | |
| L | 0.20 | 0.30 |
| L1 | --- | 0.10 |

GENERIC MARKING DIAGRAM*



XX = Specific Device Code
M = Date Code

*This information is generic. Please refer to device data sheet for actual part marking. Pb-Free indicator, "G" or microdot "▪", may or may not be present. Some products may not follow the Generic Marking.

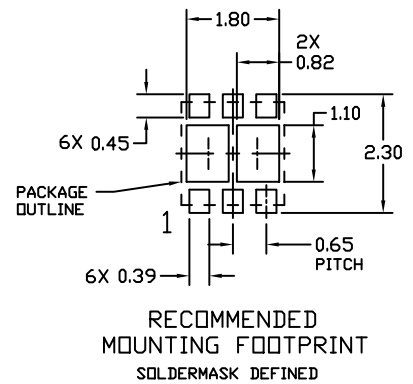

| | | |
|-------------------------|-------------------------|--|
| DOCUMENT NUMBER: | 98AON20861D | Electronic versions are uncontrolled except when accessed directly from the Document Repository. Printed versions are uncontrolled except when stamped "CONTROLLED COPY" in red. |
| DESCRIPTION: | WDFN6 2x2, 0.65P | PAGE 1 OF 1 |

onsemi and ONSEMI are trademarks of Semiconductor Components Industries, LLC dba onsemi or its subsidiaries in the United States and/or other countries. onsemi reserves the right to make changes without further notice to any products herein. onsemi makes no warranty, representation or guarantee regarding the suitability of its products for any particular purpose, nor does onsemi assume any liability arising out of the application or use of any product or circuit, and specifically disclaims any and all liability, including without limitation special, consequential or incidental damages. onsemi does not convey any license under its patent rights nor the rights of others.

onsemi, **Onsemi**, and other names, marks, and brands are registered and/or common law trademarks of Semiconductor Components Industries, LLC dba "**onsemi**" or its affiliates and/or subsidiaries in the United States and/or other countries. **onsemi** owns the rights to a number of patents, trademarks, copyrights, trade secrets, and other intellectual property. A listing of **onsemi**'s product/patent coverage may be accessed at www.onsemi.com/site/pdf/Patent-Marking.pdf. **onsemi** reserves the right to make changes at any time to any products or information herein, without notice. The information herein is provided "as-is" and **onsemi** makes no warranty, representation or guarantee regarding the accuracy of the information, product features, availability, functionality, or suitability of its products for any particular purpose, nor does **onsemi** assume any liability arising out of the application or use of any product or circuit, and specifically disclaims any and all liability, including without limitation special, consequential or incidental damages. Buyer is responsible for its products and applications using **onsemi** products, including compliance with all laws, regulations and safety requirements or standards, regardless of any support or applications information provided by **onsemi**. "Typical" parameters which may be provided in **onsemi** data sheets and/or specifications can and do vary in different applications and actual performance may vary over time. All operating parameters, including "Typicals" must be validated for each customer application by customer's technical experts. **onsemi** does not convey any license under any of its intellectual property rights nor the rights of others. **onsemi** products are not designed, intended, or authorized for use as a critical component in life support systems or any FDA Class 3 medical devices or medical devices with a same or similar classification in a foreign jurisdiction or any devices intended for implantation in the human body. Should Buyer purchase or use **onsemi** products for any such unintended or unauthorized application, Buyer shall indemnify and hold **onsemi** and its officers, employees, subsidiaries, affiliates, and distributors harmless against all claims, costs, damages, and expenses, and reasonable attorney fees arising out of, directly or indirectly, any claim of personal injury or death associated with such unintended or unauthorized use, even if such claim alleges that **onsemi** was negligent regarding the design or manufacture of the part. **onsemi** is an Equal Opportunity/Affirmative Action Employer. This literature is subject to all applicable copyright laws and is not for resale in any manner.

PUBLICATION ORDERING INFORMATION

LITERATURE FULFILLMENT:

Email Requests to: orderlit@onsemi.com

onsemi Website: www.onsemi.com

TECHNICAL SUPPORT

North American Technical Support:

Voice Mail: 1 800-282-9855 Toll Free USA/Canada

Phone: 011 421 33 790 2910

Europe, Middle East and Africa Technical Support:

Phone: 00421 33 790 2910

For additional information, please contact your local Sales Representative